

AC/DC 4000W Configurable Product



Features

- Input : 85-265Vac, 47-63Hz or 85-135Vac, 360-440Hz
- 1 to 16 outputs, 4000W Tot. max.
- Each output configurable from 3V3 to 48Vdc, 100-500W max.
- Dimensions : 86*153,5*305mm
- Surge and transient protected
- Fan cooled
- Ruggedization as an option

Safety IEC/EN 62368-1, RoHS lead-free-solder compliant
(certification pending)



Description

powerPAC4K is a high power density configurable AC-DC power supply, up to 4000W, fan cooled, incorporating EMI filtering, transient protection, output protections, robust mechanical package and connections required in most of severe environment for industrial, railways, defense type of applications. The Power Factor Correction (PFC) front end provides high power density and a high efficiency thanks to the integration of an interleaved boost conversion.

The output **converterPAC's**, inserted in the 8 slots, can be configured in single or dual outputs allowing up to 16 different outputs from 3V3 to 48Vdc. They can be put in parallel or serialised for high power configuration and integrate individual control and monitoring.

powerPAC4K is a very scalable power supply for industrial, test & measurement and can be ruggedized for more severe environments.

Block diagram

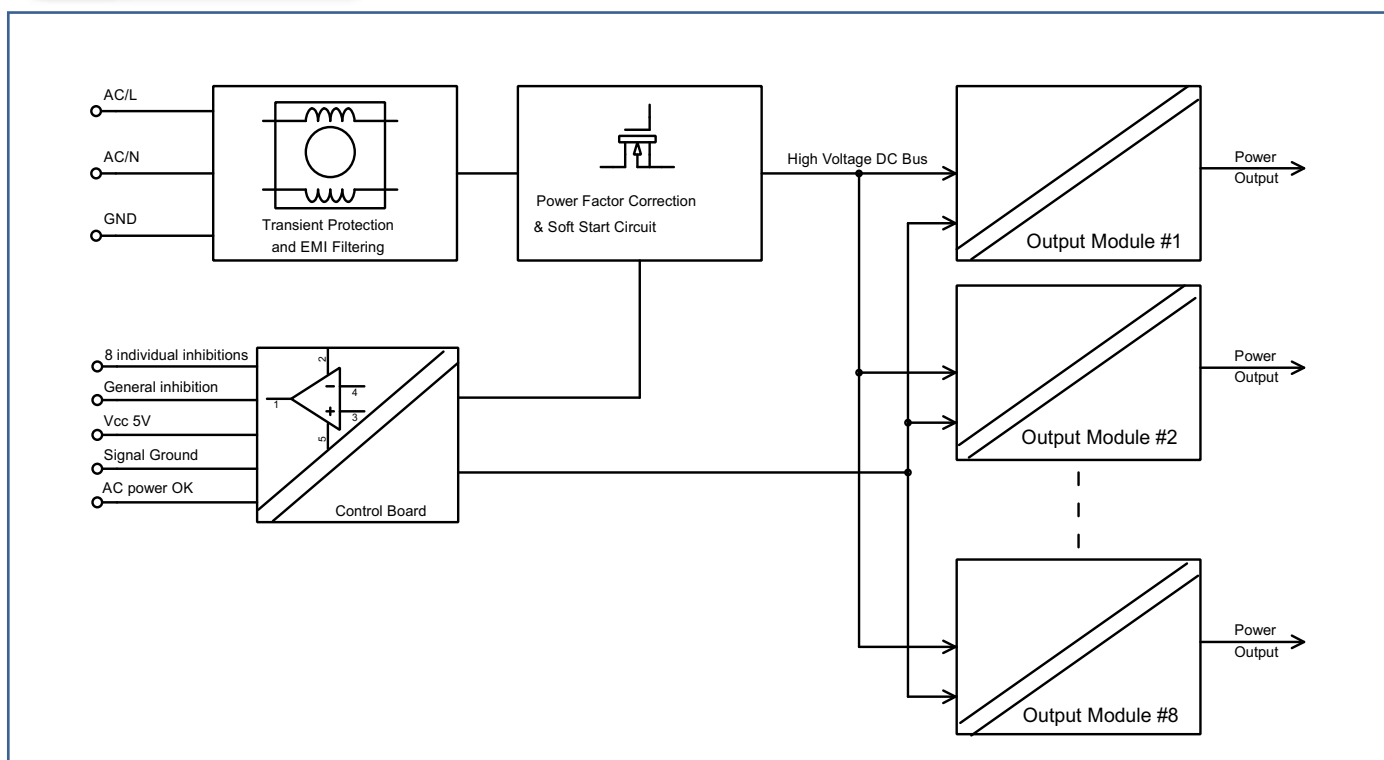

Input

Electrical Input Data

Input				Units
Characteristics	Conditions	min	typ. max	
Operating input voltage		85		265 V
Frequency range	85-265 Vac	47		63 Hz
Frequency range	85-135Vac	360		440 Hz
Power Factor	230Vac, 50Hz, P _{nom}		0,97	
Input current	Full power, Vin min.			25 A
Input power (1)	No load			15 W
	Disabled			80 W
Inrush current	Peak, at 265Vac			35 A
Start-up time			3	s

Note: (1) depend on the configuration, maximum is given for fully equipped 4000W 8 DCM output converterPAC.

Input Transient Protection

A Voltage Dependent Resistor (VDR) and a common mode input filter form an effective protection against input fast transients and surges in differential and common mode.

Input Fuse

A 30A medium blow fuse mounted inside the input filter protects against damages in case of a failure. The fuse is not user-accessible and can not be replaced for safety reason. Customer needs to ensure appropriate external fusing. Each output **converterPAC** intergrates its own fuse protection which is as well not user- accessible.

Input Inrush Current

An active soft start circuit will act as current limiting circuit. It is implemented in the Power Factor Correction through a microcontroller and digital control of the SCRThyristor. This soft start leads to extend the start up time. See graph attached for the waveform. The value of inrush current will increase with the input voltage.

Hold-up time

The hold-up time is mainly provided by the capacitors included in the Front End. Additional capacitors are added in some output **converterPAC**'s . Hold-up time is dependent on the power delivered by the different outputs with the approximate formula :

$$t_h = 75 * n / P_{out}$$

whereas :

P_{out} = output power [W]

n = efficiency [%] of the output stage

t_h = hold-up time [s]

Waveforms

Inrush Current @ 230Vac 50Hz

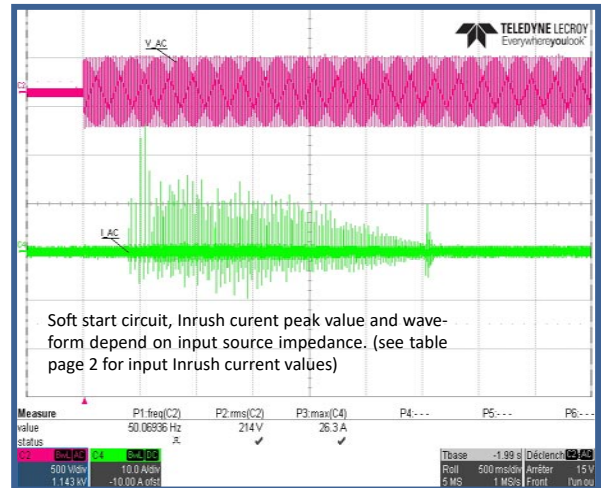

Inrush Current @ 115Vac 50Hz

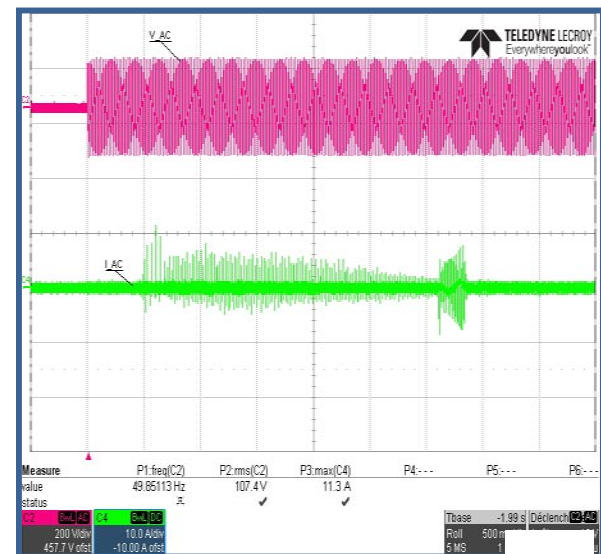

Start-up time @ 230V 50Hz

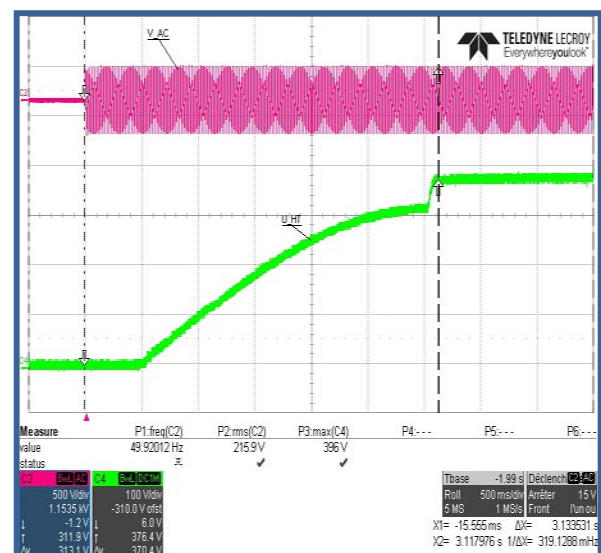

Electrical Input Data

Input Current & Power Factor

The Power factor Correction front end is ensuring an input current in phase and equal shape to the input voltage. The graphic on the top right shows power factor vs. load and line. The power derating is applied for the measurement at 85 and 115 Vac.

The curves below and right bottom show the input current waveform vs. different conditions of input line, input frequency and output power.

All conditions show distortion current well below the values requested by the standard EN61000-3-2.

Waveforms

Power Factor vs. line and load @ 50Hz

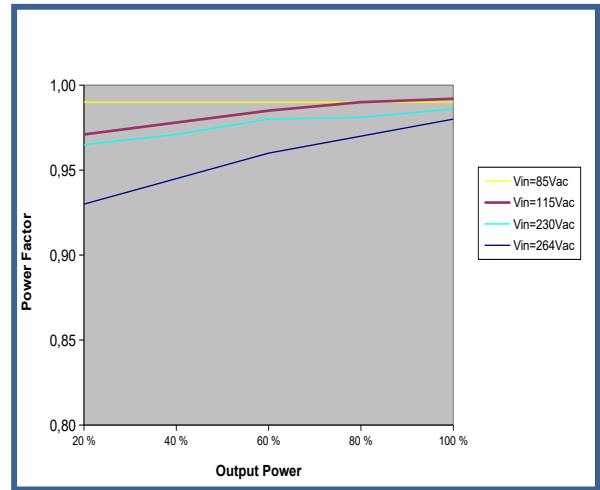

100% Output Power is 4000W for 230Vac & 264Vac, 2000W for 85Vac and 115Vac.

Input Current @ 115Vac 50Hz 2000W

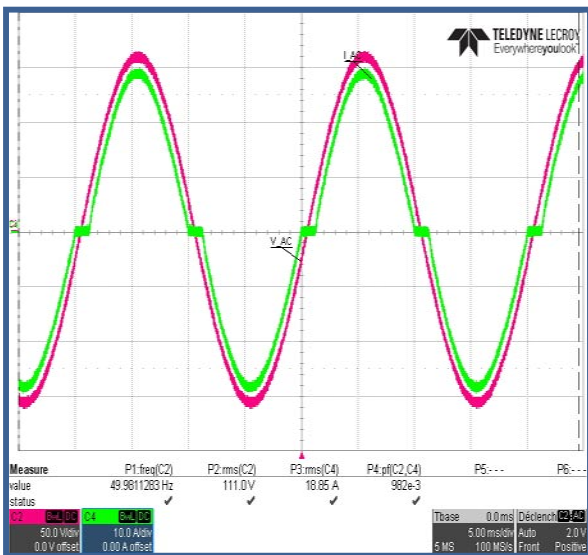

Input Current @ 230Vac 50Hz 3500W

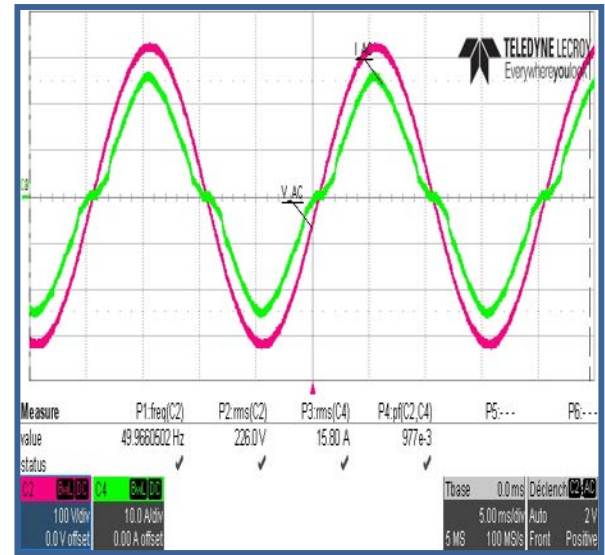

Input Current @ 115Vac 400Hz 2000W

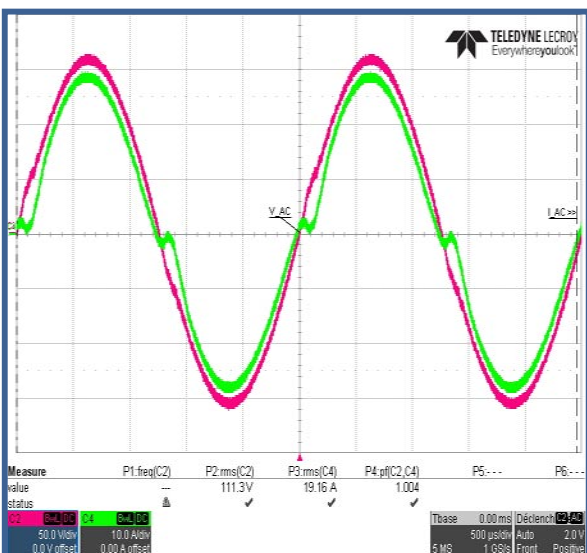

Input Current @ 230Vac 50Hz 2000W

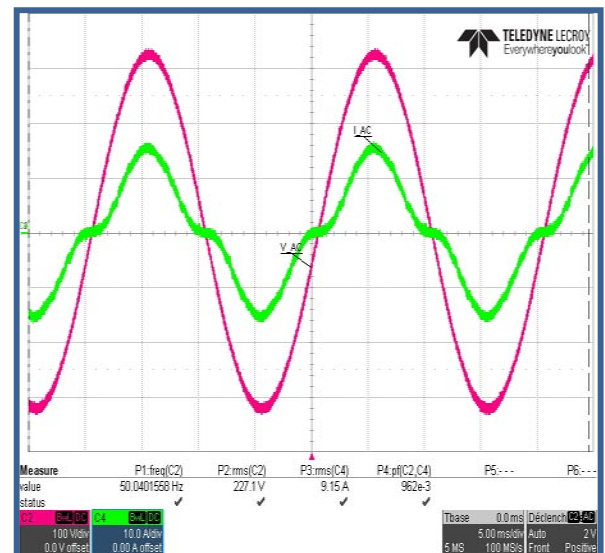

Electrical Input Data

Efficiency

Because of the many different output voltages and power configurations, the overall efficiency will differ from one model to another. Estimation of the overall efficiency may be calculated by taking into account the different efficiencies and power from each output, see output section, and efficiency of the front end for the corresponding power and input line.

An example of the calculation is done below:

Lets assume a **powerPAC4K** configuration working at 230Vac, with the following **converterPAC**'s :

48Vdc/1500W: DCM270-48500-MASTER+2*DCM270-48500-SLAVE
 28Vdc/1000W: DCM270-28500-MASTER+1*DCM270-28500-SLAVE
 +12Vdc/100W +12Vdc/100W: LLCD384-12100-12100

From the output section:

DCM270-48500-MASTER Eff. 90% Pout=1500W, P_{diss}=166W
 DCM270-28500-MASTER Eff. 90% Pout=1000W, P_{diss}=111W
 LLCD384-12100-12100 Eff. 94% Pout=200W, P_{diss}=13W

Total losses for the output stages P_{diss}=290W. The front end will deliver P_{out}+P_{diss}=2990W.

From the curves attached , Efficiency of the front end at 2990W, 230Vac η=97%, thus input power is P_{in}=2990/0.97=3082W.

The overall efficiency of this configuration is:

Tot. Eff. = $2700/3082 = 87.6\%$

Waveforms

Front End Efficiency vs. line and load @ 50Hz

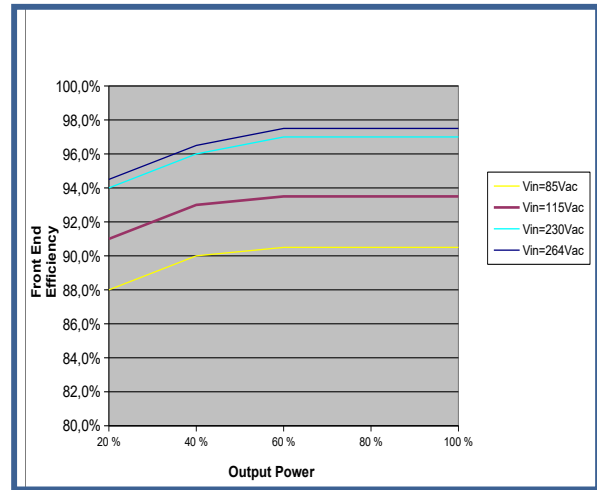

100% Output Power is 4000W for 230Vac & 264Vac, 2000W for 85Vac & 115Vac.

Output

powerPAC4K can be configured with up to 8 converterPAC on the 8 dedicated output slots. Different types of converterPAC can be placed according power and voltage of each output. Dual outputs converterPAC allows applications up to 16 outputs. See below description of each converterPAC family and in the output data section the P/N and electrical characteristics.

LLCD Dual 100W outputs

Features

- LLCD 1 slot Resonant dual outputs converter
- From 3V3 to 48Vdc / 100W (See output data section)
- Isolation with planar transformer
- Signals & monitoring
- Adjustable voltage $\pm 10\%$

Description

LLCD is a single slot isolated dual outputs converterPAC dedicated for multiple low power outputs application. Based on LLC resonant topology, it provides very high efficiency, low output noise and low EMI. It can deliver a power up to 100W on each output. This module can be configured with the same or two different output voltages and each output voltage is adjustable thanks to a potentiometer. Remote senses feature enables compensation of voltage drop across output wires and contacts. The high efficiency of this module (typ.94%) allows use without any dedicated cooling.

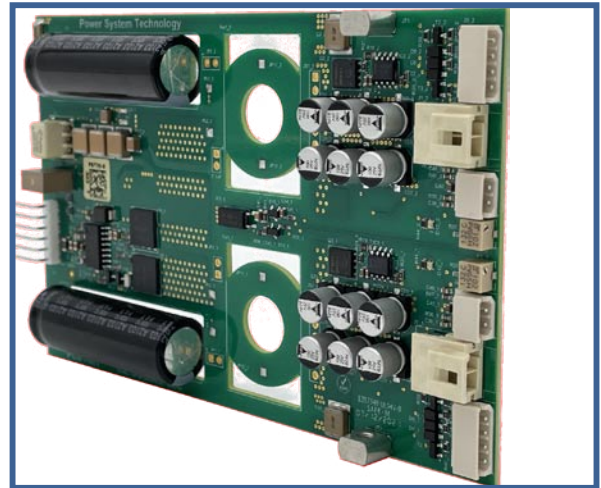

LLCD Block diagram

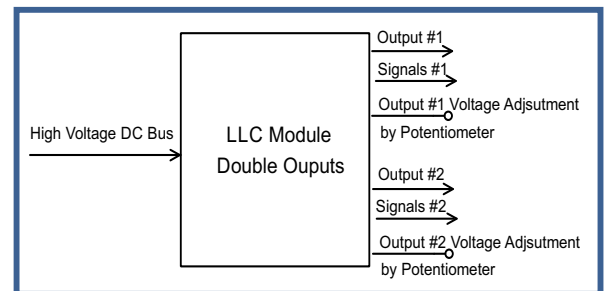

LLCS Single 200W output

Features

- LLCS 1 slot Resonant single output converter
- From 3V3 to 48Vdc / 200W (See output data section)
- Isolation with planar transformer
- Signals & monitoring
- Adjustable voltage $\pm 10\%$

Description

LLCS is a single slot isolated single output converterPAC dedicated for low power output application. Based on LLC resonant topology, it provides very high efficiency, low output noise and low EMI. It can deliver a power up to 200W and output is adjustable thanks to a potentiometer. Remote senses feature enables compensation of voltage drop across output wires and contacts. The high efficiency of this module (typ.94%) allows use without any dedicated cooling.

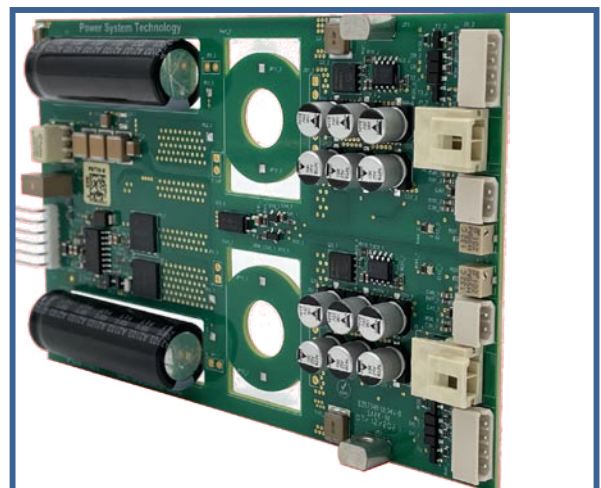

LLCS Block diagram

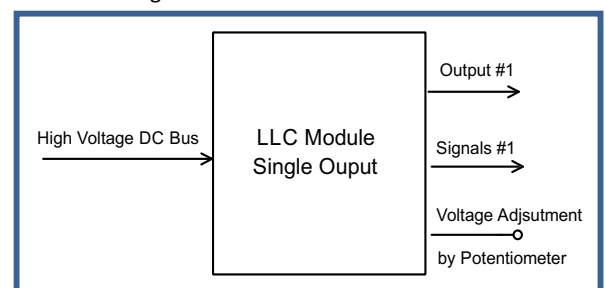

▼ Output

DCM Single 500W output

▼ Features

- DCM 1 slot single output converter
- From 3V3 to 48Vdc / 500W (See output data section)
- Paralleling and serial for high power applications
- Signals & monitoring
- Adjustable voltage $\pm 10\%$

▼ Description

This single slot isolated single output DCM **converterPAC** is specifically dedicated for single high power output application. Based on Vicor Corp. DCM Chip module, it provides high efficiency, low output noise and low EMI. It can deliver a power up to 500W on each slot in a very high power density package. Paralleling for high power application is factory configured up to 8 modules and serial configuration is possible. Integrated with low profile heatsink, it is cooled through the air flow of internal fan. Output voltage is adjustable thanks to a potentiometer, remote senses feature enables compensation of voltage drop across output wires and contacts. Signals and controls are possible through dedicated connector.



Block diagram

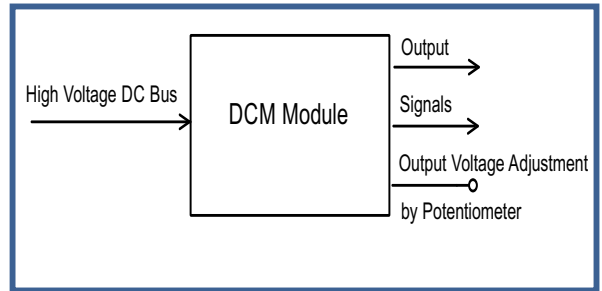

Output

Electrical Output Data - single output

General conditions : 25°C ambient.

1) Latched shutdown - 2) Output voltage falls < 95 % of nominal - 3) Nominal input, full load, 20MHz bandwidth - 4) Nominal input, full load - 5) No load to full load, nominal input

Part Number	Output Voltage		Output Power		Voltage Adjustment		Overvoltage Protection (1)			Output Current			Output Current Limit (2)			Output Noise (3)			Efficiency (4)			Load regulation (5)
	V	W	V		V			A			%			mVpp			%			V		
	Nom.	Nom.	Min.	Typ. Max.	Min.	Typ.	Max.	Min.	Typ.	Max.	Min.	Typ.	Max.	Min.	Typ.	Max.	Min.	Typ.	Max.	Typ.		
DCM converterPAC																						
DCM270-3V3250	3V3	150	3.00	3.63	4.2			0	45	100	120	136	70			80					0.1	
DCM270-5250	5V	250	4.5	5.5	6.2			0	50	100	120	145	80			89					0.1	
DCM270-12500	12V	500	10.8	13.2	15			0	41	100	120	150	115			91					0.1	
DCM270-15500	15V	500	13.5	16.5	19			0	33	100	120	139	115			92					0.1	
DCM270-24500	24V	500	21.6	26.4	30			0	21	100	120	145	170			91					0.1	
DCM270-28500	28V	500	25.2	30.8	35			0	18	100	120	140	105			92					0.1	
DCM270-48500	48V	500	43.2	52.8	60			0	10,5	100	120	140	200			90					0.1	
LLCS converterPAC single slot single output																						
LLCS384-3V3150	3V3	150	3.00	3.63				0	45.5	100	130	136	70			91					0.1	
LLCS384-5200	5V	200	4.5	5.5				0	40	100	130	145	80			91					0.1	
LLCS384-12200	12V	200	10.8	13.2				0	17	100	130	150	115			94					0.1	
LLCS384-15200	15V	200	13.5	16.5				0	13.3	100	130	139	115			94					0.1	
LLCS384-24200	24V	200	21.6	26.4				0	8.3	100	130	145	170			94					0.1	
LLCS384-28200	28V	200	25.2	30.8				0	7.2	100	130	140	105			94					0.1	
LLCS384-48200	48V	200	43.2	52.8				0	4.2	100	130	140	200			94					0.1	

Output

Electrical Output Data - Dual outputs

General conditions : 25°C ambient.

1) Latched shutdown - 2) Output voltage falls < 95 % of nominal - 3) Nominal input, full load, 20MHz bandwidth - 4) Nominal input, full load - 5) No load to full load, nominal input

Part Number	Channel (See Pin allocation table)	Output Voltage		Output Power		Voltage Adjustment			Overvoltage Protection (1)			Output Current			Output Current Limit (2)			Output Noise (3)			Efficiency (4)			Load regulation (5)
		V	W	V	W	Min.	Typ.	Max.	V	V	V	A	A	A	%	%	%	mVpp	mVpp	mVpp	%	%	%	V
		Nom.	Nom.	Min.	Typ.	Max.	Min.	Typ.	Max.	Min.	Typ.	Max.	Min.	Typ.	Max.	Min.	Typ.	Max.	Min.	Typ.	Max.	Min.	Typ.	Max.
LLCD converterPAC single slot dual outputs																								
LLCD384-5100-5100	1	5V	100	4.5	5.5						0	20	100	130	145			80			91			0.1
	2	5V	100	4.5	5.5						0	20	100	130	145			80			91			0.1
LLCD384-5100-12100	1	5V	100	4.5	5.5						0	20	100	130	145			80			91			0.1
	2	12V	100	10.8	13.2						0	8.3	100	130	150			115			94			0.1
LLCD384-5100-15100	1	5V	100	4.5	5.5						0	20	100	130	145			80			91			0.1
	2	15V	100	13.5	16.5						0	6.7	100	130	130			115			94			0.1
LLCD384-5100-24100	1	5V	100	4.5	5.5						0	20	100	130	145			80			91			0.1
	2	24V	100	21.6	26.4						0	4.2	100	130	145			170			94			0.1
LLCD384-5100-28100	1	5V	100	4.5	5.5						0	20	100	130	145			80			91			0.1
	2	28V	100	25.2	30.8						0	3.5	100	130	140			105			94			0.1
LLCD384-5100-48100	1	5V	100	4.5	5.5						0	20	100	130	145			80			91			0.1
	2	48V	100	43.2	52.8						0	2.1	100	130	140			200			94			0.1
LLCD384-12100-12100	1	12V	100	10.8	13.2						0	8.3	100	130	150			115			94			0.1
	2	12V	100	10.8	13.2						0	8.3	100	130	150			115			94			0.1
LLCD384-12100-15100	1	12V	100	10.8	13.2						0	8.3	100	130	150			115			94			0.1
	2	15V	100	13.5	16.5						0	6.7	100	130	130			115			94			0.1
LLCD384-12100-24100	1	12V	100	10.8	13.2						0	8.3	100	130	150			115			94			0.1
	2	24V	100	21.6	26.4						0	4.2	100	130	145			170			94			0.1
LLCD384-12100-28100	1	12V	100	10.8	13.2						0	8.3	100	130	150			115			94			0.1
	2	28V	100	25.2	30.8						0	3.5	100	130	140			105			94			0.1
LLCD384-12100-48100	1	12V	100	10.8	13.2						0	8.3	100	130	150			115			94			0.1
	2	48V	100	43.2	52.8						0	2.1	100	130	140			200			94			0.1
LLCD384-15100-15100	1	15V	100	13.5	16.5						0	6.7	100	130	130			115			94			0.1
	2	15V	100	13.5	16.5						0	6.7	100	130	130			115			94			0.1
LLCD384-15100-24100	1	15V	100	13.5	16.5						0	6.7	100	130	130			115			94			0.1
	2	24V	100	21.6	26.4						0	4.2	100	130	145			170			94			0.1
LLCD384-15100-28100	1	15V	100	13.5	16.5						0	6.7	100	130	130			115			94			0.1
	2	28V	100	25.2	30.8						0	3.5	100	130	140			105			94			0.1
LLCD384-15100-48100	1	15V	100	13.5	16.5						0	6.7	100	130	130			115			94			0.1
	2	48V	100	43.2	52.8						0	2.1	100	130	140			200			94			0.1
LLCD384-24100-24100	1	24V	100	21.6	26.4						0	4.2	100	130	145			170			94			0.1
	2	24V	100	21.6	26.4						0	4.2	100	130	145			170			94			0.1
LLCD384-24100-28100	1	24V	100	21.6	26.4						0	4.2	100	130	145			170			94			0.1
	2	28V	100	25.2	30.8						0	3.5	100	130	140			105			94			0.1
LLCD384-24100-48100	1	24V	100	21.6	26.4						0	4.2	100	130	145			170			94			0.1
	2	48V	100	43.2	52.8						0	2.1	100	130	140			200			94			0.1
LLCD384-28100-28100	1	28V	100	25.2	30.8						0	3.5	100	130	140			105			94			0.1
	2	28V	100	25.2	30.8						0	3.5	100	130	140			105			94			0.1
LLCD384-28100-48100	1	28V	100	25.2	30.8						0	3.5	100	130	140			105			94			0.1
	2	48V	100	43.2	52.8						0	2.1	100	130	140			200			94			0.1
LLCD384-48100-48100	1	48V	100	43.2	52.8						0	2.1	100	130	140			200			94			0.1
	2	48V	100	43.2	52.8						0	2.1	100	130	140			200			94			0.1

Electrical Output Data - functionalities

Output voltage regulation

The **converterPAC** provides a regulated output voltage vs. load variation. See Electrical output data for Output voltage regulation value according part number. This value is usually defined from 10 to 90% of nominal current variation. Dynamic fast transient load variation will differ in behaviour according step variation and will lead to overshoot and undershoot.

Output voltage Ripple and noise

The **converterPAC** provides a dedicated output filtering which limits output noise. The LLCs and LLCD converters are even optimized to provide very low noise , typ. 10-30mVpp, ideally for very sensitive application. Output voltage ripple is measured on the 20Mhz bandwidth. See attached example of measurement.

Parallel and Series Connection

A converter output can be connected in series with an output from a separate converter, a diode across each output may be implemented externally (Cathode to +OUT) to provide continuity in case of one failure. The maximum output current of a serial-connected output is limited by the output with the lowest current limit. Output voltages above 48V (SELV - Safety Extra Low Voltage) require additional safety measures in order to comply with international safety requirements. Parallel operation is possible for DCM **converterPAC** to increase output power up to 4000W. No parallel signal used and the unit will work in droop share mode by internal configuration.

Thermal Considerations

The Front End and **converterPAC** are internally fan cooled. The max. operating temperature is defined at 40°C for full power configuration, 4000W@230Vac or 2000W@115Vac. Below Power vs. ambient curve shows derating to apply for higher operating temperature. Nevertheless, this curve has to be considered as general behaviour and it may vary according output voltages configuration as efficiency and power available will differ.

Waveforms

Output voltage Regulation LLC 12V output

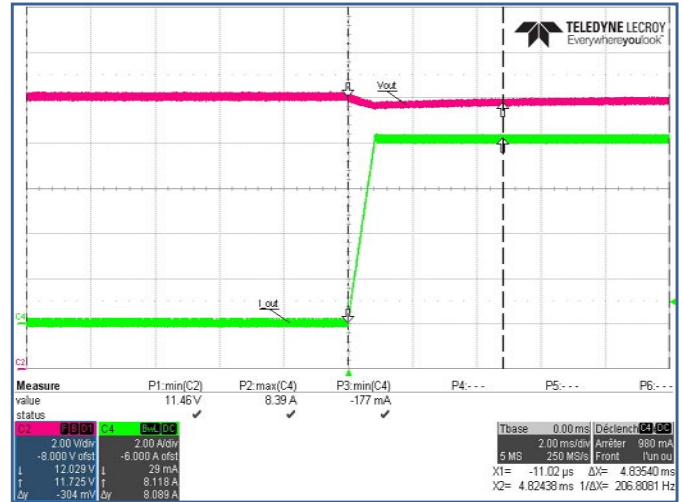

Output voltage Regulation 5V / 150A converterPAC

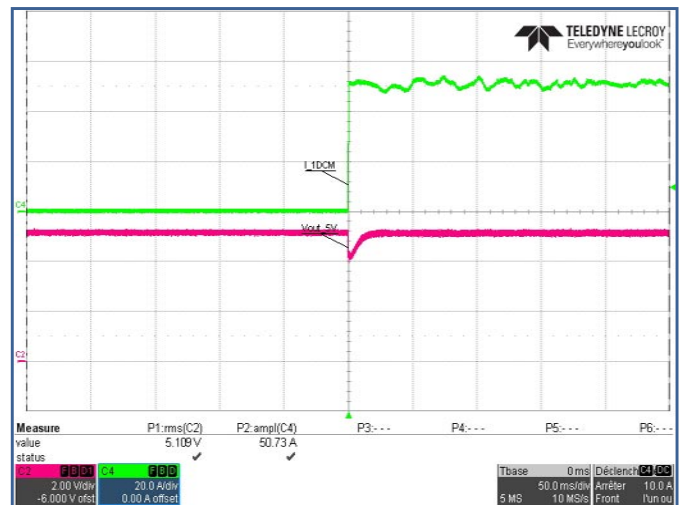

Output voltage Ripple and noise 5V / 50A converterPAC

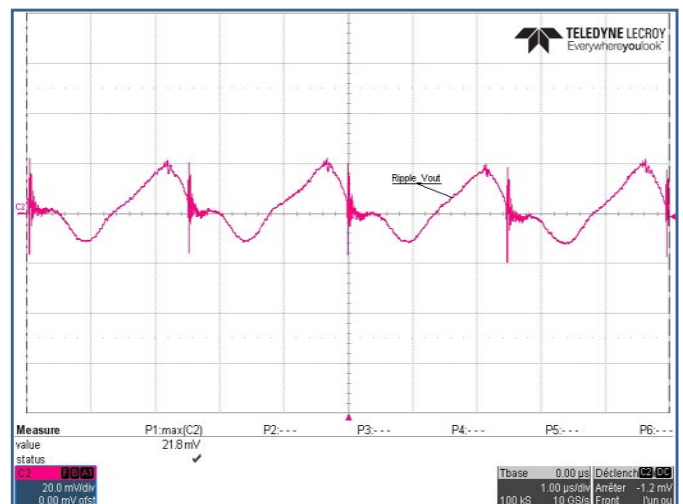

Power vs. Ambient temperature

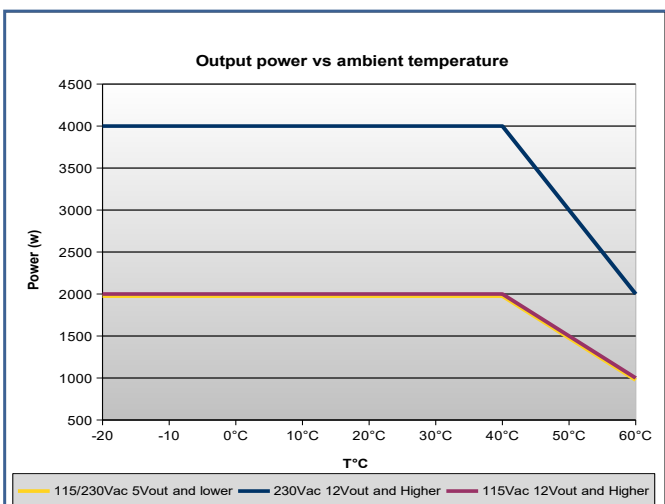

Electrical Output Data - Protection and Signals

Output Current Limitation

See Electrical output data for current limitation value according part number.

The **converterPAC** output is continuously protected against short-circuit or current limitation by disabling the power train when output current goes above the value from the table. When the default disappear, the converter will go back to normal operation after initialization. If overload is persistent, output voltage will go in a stop-start mode operation.

Output OVP

The **converterPAC** includes output overvoltage protection (OVP) which will stop the converter in the event of an overvoltage. This protection is latched type and converter will restart by either disabling the corresponding output or restarting the power supply. See output data table above for the value according output voltages. Nevertheless exceeding these values may damage the converter. Protection not included in the LLC and LLCDC converter.

Thermal protection OTP

A temperature protection is integrated in each high power **converterPAC** module, disabling output when internal heatsink temperature exceeds normal range. The converter automatically restarts, when the temperature drops below this limit. Nevertheless, exceeding the max operating temperature may cause failures of the converter.

Enable/Disable (Individual and General ON/OFF)

INH_GENERAL: (J500_12) active low, will disable all output slots at the same time when connected to Signal Ground (J500-10).

E/D-1 to E/D-8: (J500_1 to 8) active low, will disable corresponding slot when connected to Signal Ground (J500_10). If dual outputs slot is used, both outputs will be controlled at the same time.

Do not exceed TTL level if voltage controlled. If left open, unit will operate.

AC POWER OK

AC_POWER_OK: (J500_11) TTL active high in normal operation, will go low when the main line disappear and/or internal intermediate bus voltage goes below 350Vdc. Using this signal, customer can save data or whatever until output voltages disappear. AC_POWER_OK is referenced to Signal Ground. Attached example of AC_POWER_OK behaviour vs. output voltages.

Auxiliary 5VCC

+5Vcc: (J500_9) A 5Vdc auxiliary power supply is provided to the customer application in order to manage signals. Do not exceed 200mA consumption. This signal is referenced to Signal Gound (J500_10).

Powergood

Each output converter slots provides a Powergood (PGD), active High, and an inverted Powergood (PGD_INV), active low, which are active when output voltage is in its normal range. These two signals are open collector but are tight to VCC_IN and S_GND trough pull up resistors. A 5VCC max. voltage can be applied to get the attached levels (consumption 500µA).

The normal range is considered between 0.9 Vnom. and 1.2Vnom. typically. The signals are located on the **converterPAC** in J3 for LLC and J4 for DCM.

Waveforms

Enable / Disable diagram

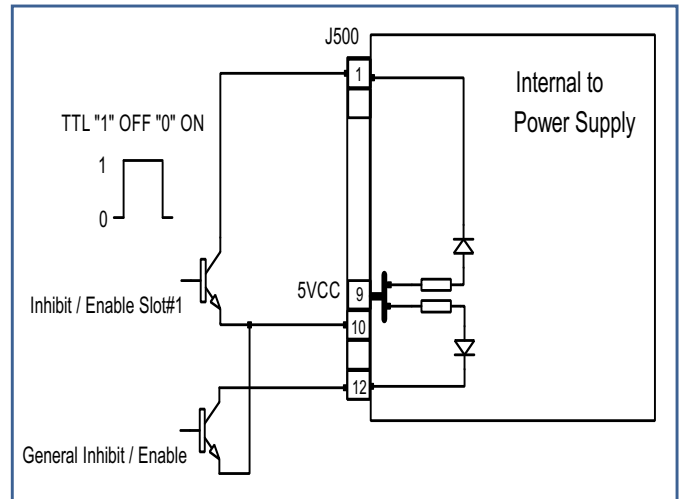

AC POWER OK

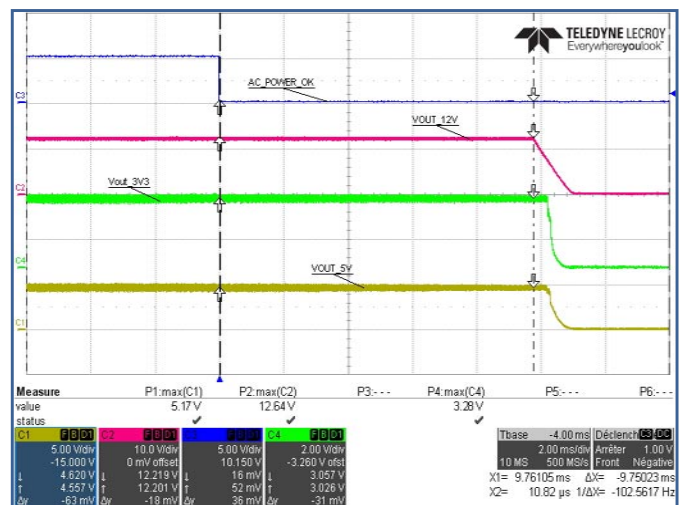

Powergood

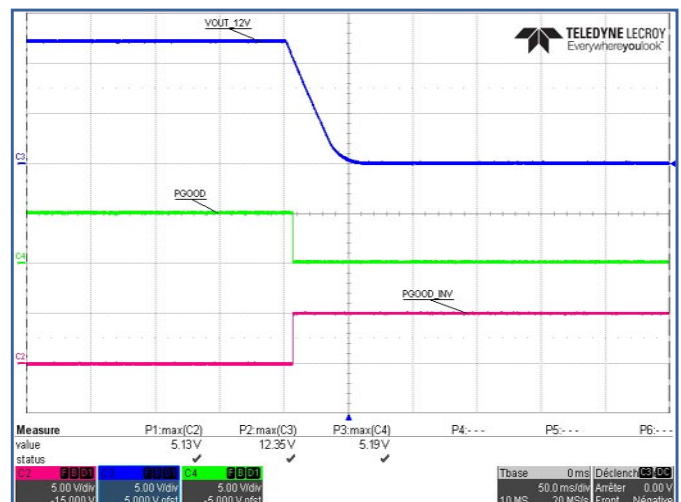

Electrical Output Data - Protection and Signals

Sense Lines

+Sense, -Sense: Each output implement remote sensing which enables compensation of voltage drop accross the connector contacts and the load cabling by connecting +S and -S at the load location. The overall voltage compensation in the + and - power lines should not exceed +10% of the nominal output voltage.

Output Voltage Adjustment

The output voltage of the **converterPAC** can be adjustable by potentiometer P1, placed at the output side, between +10% to -10% of the nominal voltage. If the remote senses are used, the output voltage at the output load of the **converterPAC** can be considered. As an example , if a 12Vout is used and sensing is compensating 10%, the adjustment is allowed at 13.2V +10%.

Output Led

A green led at the **converterPAC** output indicates the presence of corresponding voltages.

Options Description

Ruggedization (-M)

The **powerPAC4K** can be ruggedized to be built to meet MIL-STD810E, MIL-STD461E CE102. -M option at the end of the P/N will define this option.

Waveforms

Current Limitation

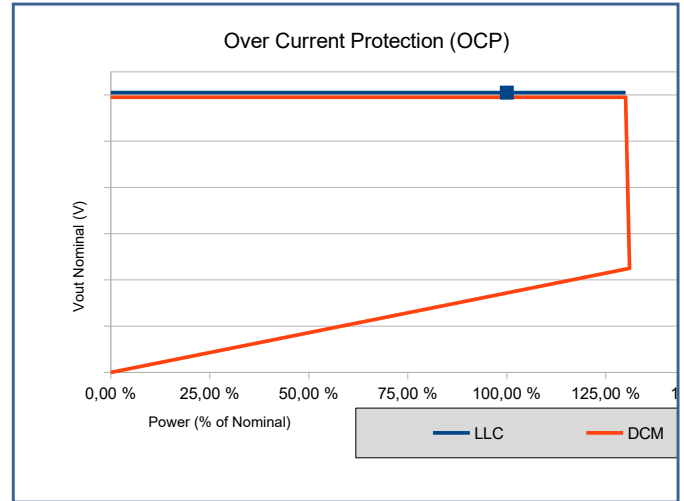

Environmental

Electromagnetic Immunity

		Standard		Level	Value	Waveform	Source imped.	Test procedure	Mode	Criteria
Surges	Built to meet	EN 61000-4-5		3	1KV	1,2 / 50 μ s	2 ohms		OP	A
					2KV	1,2 / 50 μ s	12 ohms		OP	B
Electrostatic discharge (to case)	Built to meet	EN 6100-4-2		4	8000V	1 / 50 μ s	330 Ohms	10 pos., 10neg.	OP	B
Electrical fast transients/burst	Built to meet	EN 61000-4-4		4	4000V	5 / 50 μ s	50 ohms		OP	B

Note : Built to meet EN 61000-4 -3, -6, -11, Harmonics EN 61000-3-2, Flickers EN 61000-3-3

Electromagnetic Emissions

According to the output voltages and power configuration, EMI results could change. As in some systems where input cabling is significant, an external filter may be required to meet the level below EN55022 B and MIL-STD461E CE102.

Example of EMI emission **powerPAC4K** 5V-150A, 3V3-135A, +-12V-8A @230Vac/50Hz

Example of EMI emission **powerPAC4K** 5V-150A, 3V3-135A, +-12V-8A @115Vac/50Hz

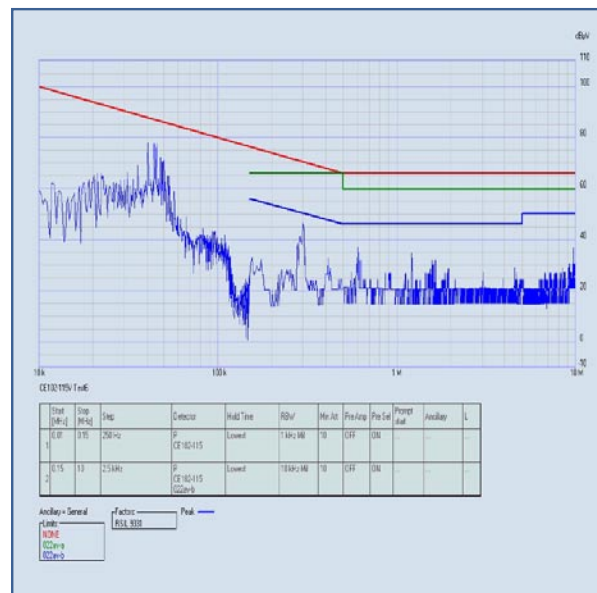
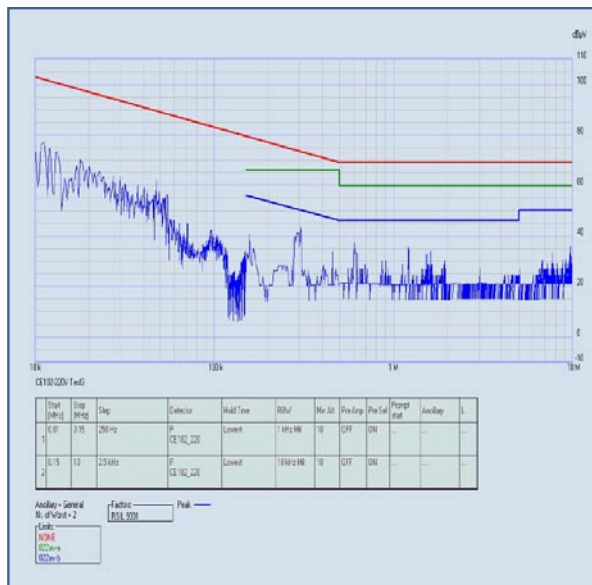

Immunity to Environmental Conditions

Test method	Standard	Test conditions	Status
Damp Heat	MIL STD 810F Proc. 507-2	Humidity 93 %, 40°C, 56 days	Option (-M), built to meet
Shock	MIL STD 810F Proc.516.3	20g / 18ms half size 5g / 30ms	Option (-M), built to meet
Vibrations	MIL STD 810F Proc. 514-5	4-80Hz (2,8m/s ²)/Hz, non operating 160-500Hz (0,175m/s ²)/Hz, non operating	Option (-M), built to meet

Safety and Installations Instructions

Temperatures

Conditions		Standard			M option			Unit
		Min.	Typ.	Max.	Min.	Typ.	Max.	
Ambiant	Operating (see derating)	0		+60	-20		+60	°C
Storage	Not operating	-40		+85	-40		+85	°C

Electric Strength

Characteristic		Input to Earth	Input to Output	Output to Earth	Output to Output	Unit
Electric strength	Design strength	1500	3000	500		Vrms
	Factory test for production units (>10s)	2120	2120	500		Vdc
Insulation resistance @ 500Vdc				> 100	>100	Mohms

Connector Pin Allocation

J1 : Input Connector
Phoenix Contact PN : 1719202

PIN	signal name	description
1	GND	Earth
2	AC/N	AC Neutral
3	AC/L	AC Line

JE_500 : Signals Connector
MOLEX 12 pins MiniSpox PN : 22-05-7125

PIN	signal name	description
1	E/D-1	Inhibition Module #1
2	E/D-2	Inhibition Module #2
3	E/D-3	Inhibition Module #3
4	E/D-4	Inhibition Module #4
5	E/D-5	Inhibition Module #5
6	E/D-6	Inhibition Module #6
7	E/D-7	Inhibition Module #7
8	E/D-8	Inhibition Module #8
9	Vcc 5V	+5Vcc, 0,3A
10	Vcc 5V	Signal Ground
11	AC POWER OK	AC Power OK
12	INH GENERAL	General Inhibition



Safety and Installations Instructions

Connector Pin Allocation LLCs & LLCd converterPAC

Output Connector J1_1 & J1_2
Molex ULTRAFIT HDR PN : 172310-4102

PIN	signal name	description
1	VCC_RTN	VCC Return
2	VCC	VCC

Sensing Connector J2_1 & J2_2
MOLEX 2 pins MiniSpox PN : 22-05-7025

PIN	signal name	description
1	+S	+Sense
2	-S	-Sense

Signals Connector J3_1 & J3_2
MOLEX 4 pins MiniSpox PN : 22-05-7045

PIN	signal name	description
1	S_GND	Signal ground
2	PGD_INV	Powergood inverted
3	PGD	Powergood
4	VCC_IN	5V / 0,5mA

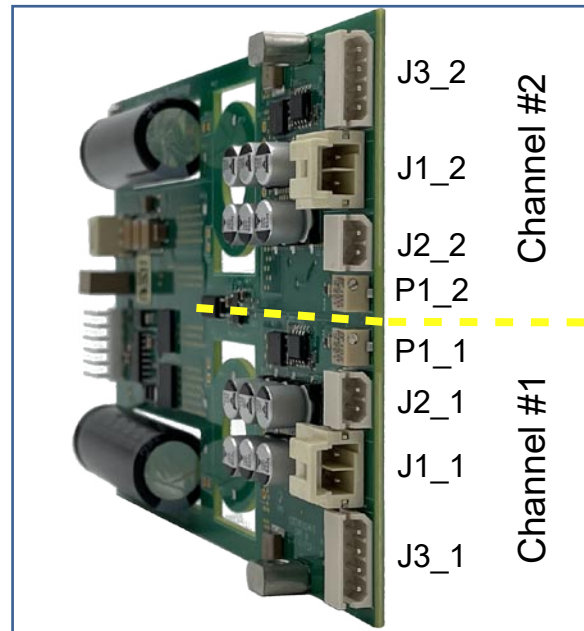

Connector Pin Allocation DCM converterPAC

Output Connector
Würth Elektronik PN : 74622104

PIN	signal name	description
+V	+V	+Vout
-V	-V	-Vout

J4 : Signals Connector
MOLEX 4 pins MiniSpox PN : 22-05-7045

PIN	signal name	description
1	S_GND	Signal ground
2	PGD_INV	Powergood inverted
3	PGD	Powergood
4	VCC_IN	5V / 0,5mA

J5 : Sensing Connector
MOLEX 2 pins MiniSpox PN : 22-05-7025

PIN	signal name	description
1	+S	+Sense
2	-S	-Sense

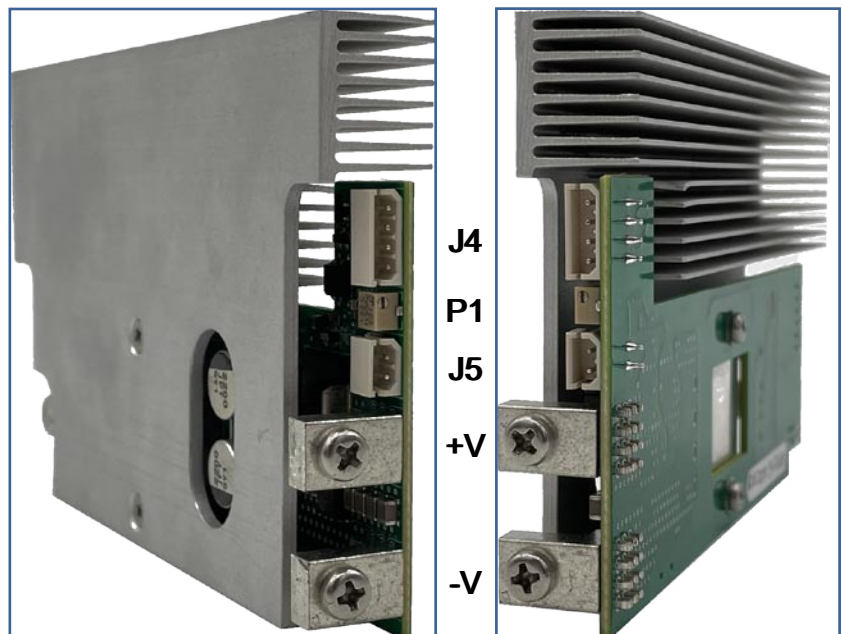

Safety and Installations Instructions

Mechanical Datas

Dimensions: 86 x 153,5 x 305mm
Weight : 5.5kg will vary according configuration

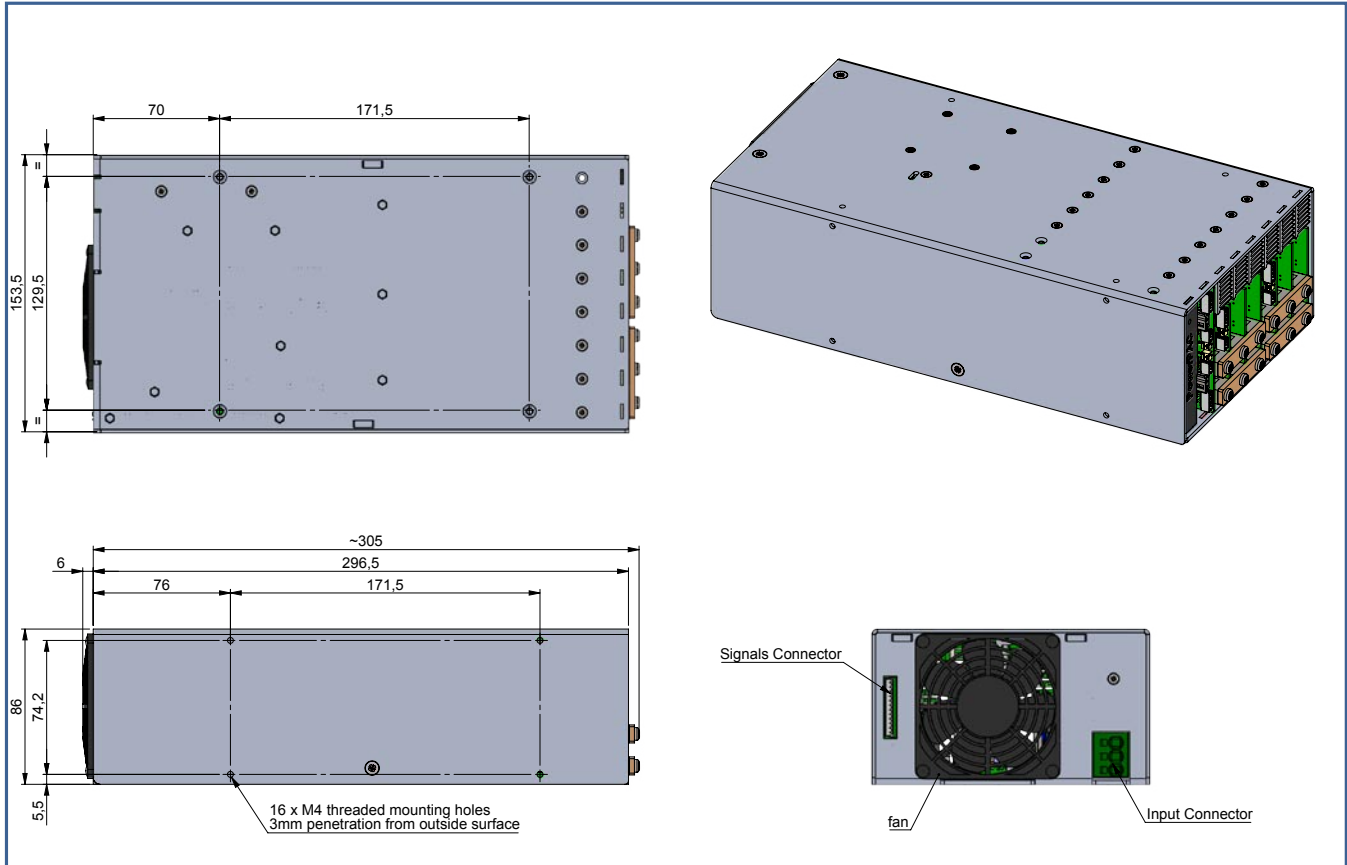

Part number & configuration

Each configuration has a specific part numbering with front end option, date code and sequential number. A configuration sheet will be provided within quote . Example PP4K-2203225.

Front End PP2K or PP4K depending on the power required, 2203 is the year and month of the definition, 225 sequential number.

Bottom left side table shows the **converterPAC** part numbers for the configuration with voltage & current per slots and bottom right side table shows the arrangement in the box , including bus bar output connection and black piece filling empty slots.

	Output Converter type		Output Characteristics				
	PIN	Slots size	Vout (V)	Iout (A)	Vout (V)	Iout (A)	P max. (W)
SLOT 1	LLCS384-5200	1	5	40			200
SLOT 2	LLCS384-48200	1	48	4,2			200
SLOT 3	DCM270-282500-MASTER	1	28	9			500
SLOT 4	DCM270-282500-SLAVE	1	28	9			500
SLOT 5	DCM270-282500-SLAVE	1	28	9			500
SLOT 6	N/A						
SLOT 7	DCM270-242500-MASTER	1	24	10,4			500
SLOT 8	N/A						
Chassis	PP2K						
Total		6					2400

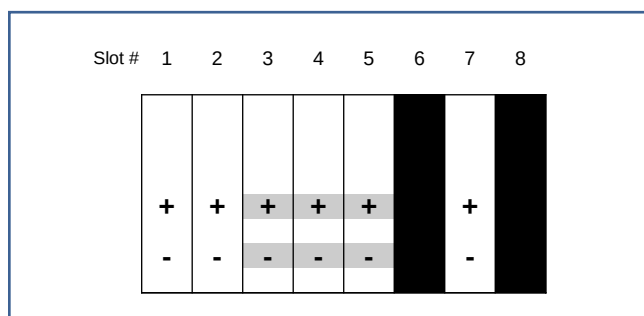

Installation Instructions

powerPAC4K AC-DC converters are considered as components or sub assembly, intended exclusively for integration into other equipment by an industrial assembly process or by a professionally competent person. Installation must strictly follow the safety regulations in respect of the enclosure, mounting, creepage and clearance distances, markings of the end-use application.

Connection to the system shall be made via appropriate connection wiring safety insulation and gauge. The Vac is internally fused. This fuse is designed to protect the converter against overcurrent caused by an internal abnormal current consumption, but may not be able to satisfy all requirements. External fuses in the wiring circuit to one or both input pins may be necessary to ensure compliance with local requirements.

To ensure a good airflow, maintain a 5cm (0.2in) clearance at each end sides. The fan airflow is approximately 1.2m³/min (42cfm).

The **powerPAC4K** can be mounted on any of its four sides using M4 mounting screws. Do not exceed a maximum penetration of **3 mm (0.12in)** and a maximum tightening torque of 2N.m (18lb.in). See mechanical datas for further informations.

Use proper size wires to avoid overheating and excessive voltage drop.

To avoid mechanical stress on input/output connexions, pay attention to cables bending radius after their connection to the PSU. Use cable ties or fixations to support heavy cables.

If the **powerPAC4K** is exposed to excessive shocks of vibrations, use shock-absorption mounting pads according to levels and frequencies applied.

Take standard ESD protections when handling **powerPAC4K**.

Safety Instructions

Never connect or disconnect the output wires of the **converterPACs** while the **powerPAC4K** is operating. They are not designed for hot-plug applications and may cause damage to the power supply.

ALWAYS turn the power supply OFF before connecting or disconnecting input/output wires. Hazardous voltages within : wait 5 minutes before removing or installing connections wires after powering off the power supply.

ALWAYS connect ground connection (GND) according to J1 connector pin allocation.

Hot surfaces can occur when the power supply is operating and remain after powering off. Use proper safety protections

Cleaning Agents and Process

The converters are not hermetically sealed. In order to avoid possible damage, any penetration of liquids shall be avoided.

Isolation

The electric strength test is performed in the factory in accordance with IEC/EN 62368.

Standards and Approvals

The converters are built to meet the safety standards IEC 62368-1, EN 62368-1.

'Built to meet' mentioned in the different paragraphs of the datasheet means that Power System Technology has designed the product to meet the standard but did not certify it in a laboratory.

Warranty

powerPAC4K and **converterPACs** are not user serviceable. They must be returned to the factory after obtaining a Returned Authorization Number (RMA) from our customer service.

The warranty will be voided if the power supply is used in any manner other than the specifications described in this datasheet or if it has been opened.

The warranty will be void if user attempt to repair or modify the **powerPAC4K** or **converterPACs** himself.

Ihr Vertriebspartner:



HY-LINE Power Components
Vertriebs GmbH
Inselkammerstr. 10
D-82008 Unterhaching
☎ +49 89/ 614 503 -10
power@hy-line.de

HY-LINE AG
Hochstrasse 355
CH-8200 Schaffhausen
☎ +41 52 647 42 00
info@hy-line.ch