

# SIRIO

**I**nductive  
**C**omponents

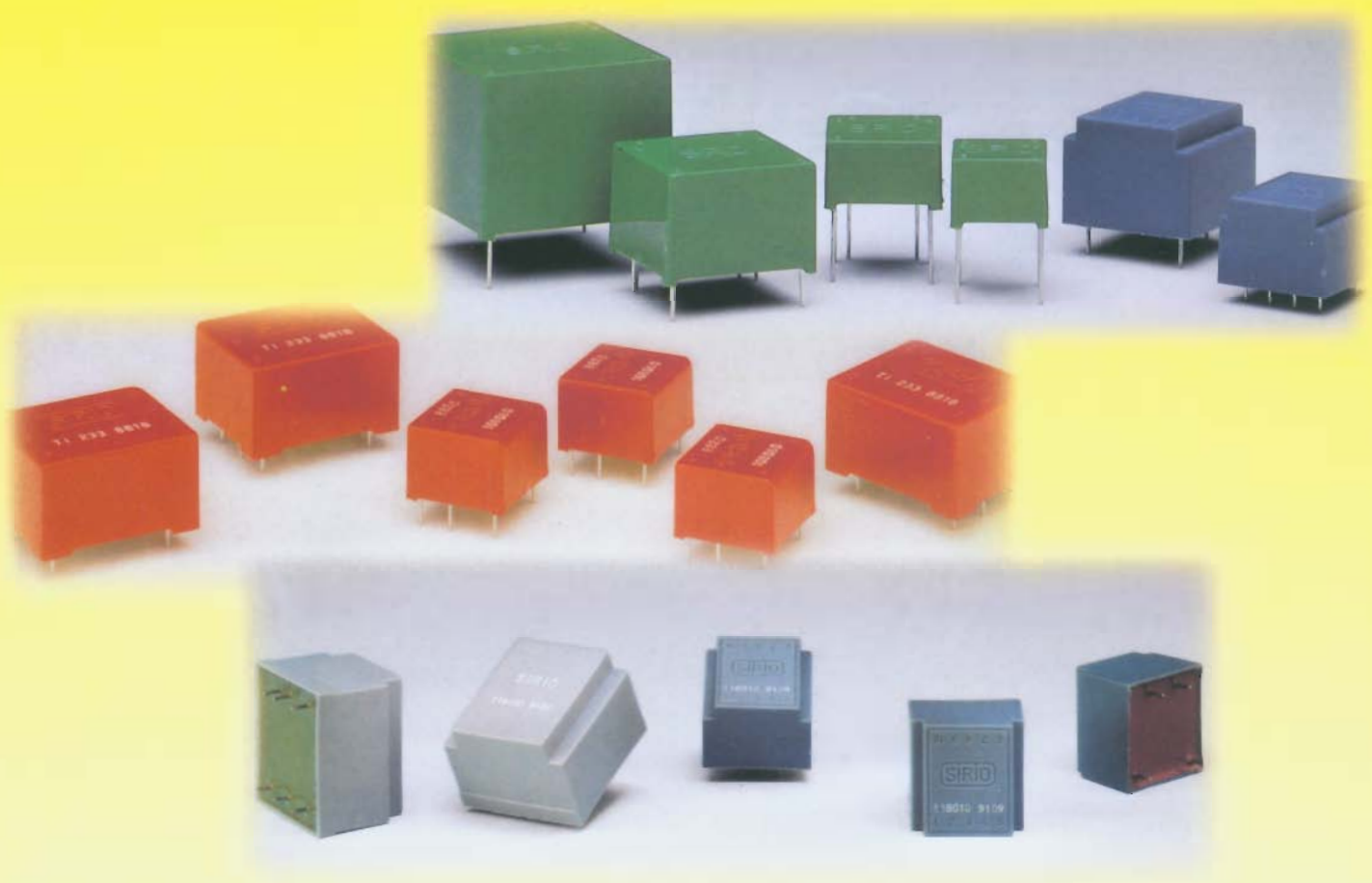

## Pulse Transformers

**Ihr Vertriebspartner:**  
**HY-LINE®**  
POWER COMPONENTS

Inselkammerstraße 10  
D-82008 Unterhaching  
Tel.: +49 (0)89 614503 10  
Fax: +49 (0)89 614503 20  
E-Mail: [power@hy-line.de](mailto:power@hy-line.de)  
URL: [www.hy-line.de](http://www.hy-line.de)

# Pulse Transformers

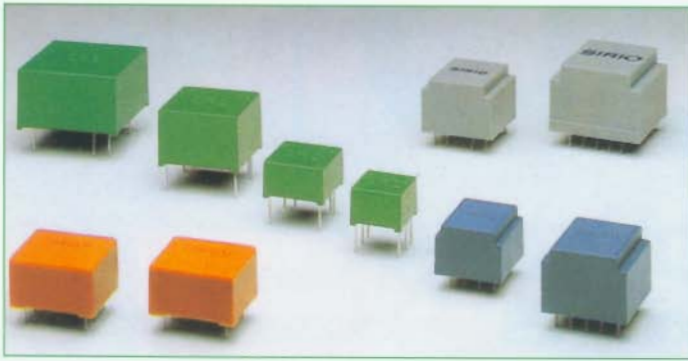

In this catalogue we present our range of standard transformers, designed for firing thyristors and triacs having low, medium and high powers.

A core having a high saturation inductance and low losses obtains a moderately dimensioned component with excellent square-shaped response. Reliability is ensured by a precise production and by checks performed during production and final tests as well.

Besides this standard range, we can offer pulse transformers with different transforming ratios, special insulation voltage and values exceeding  $\mu\text{Vs}$ , in order to meet any requirement on our customers' part.

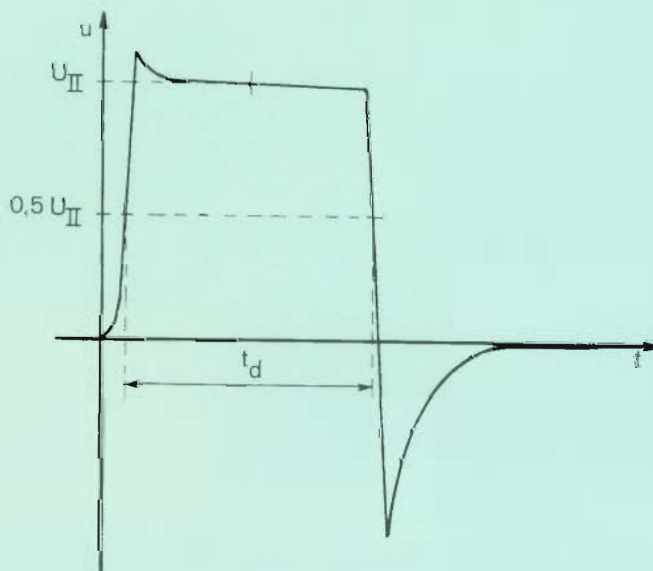

$$\int u dt = U_{II} t_d$$

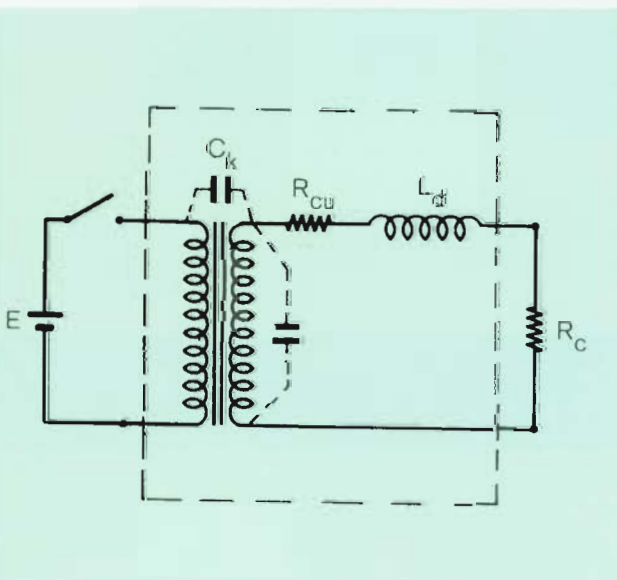

Insulation transformers, designed for triacs or thyristor firing, need the following characteristics:

- A) They can transfer unipolar pulses having a proper amplitude and duration with a low input of magnetizing current.
- B) They have well coupled magnetic coils which can transfer high  $di/dt$ .
- C) They have uncoupled electric coils which do not cause unrequired firings.
- D) They present a high insulation rate between windings and can ensure it for a long time.
- E) They have low losses.
- F) They have compact sizes.

As you can see, they meet quite contrasting needs. This aim can be reached only by choosing suitable magnetic materials and correct shapes, and by following special production techniques.

As to a quantity definition of these characteristics, we suggest

# Pulse Transformers

the following parameters:

A) Transfer area: it is the product of voltage amplitude at transformers secondary winding per its duration, when an unipolar pulse is applied at the primary and the secondary is without load. Measurement unit is ( $\mu\text{Vs}$ ). This parameter indicates the minimum area «voltage-time» which can be transferred from the primary to the secondary, without saturation phenomena at magnetic core.

$n$  = winding ratio between primary and other coils.

B)  $di/dt$ : this parameter is function of all RLC values distributed in the transformer and the load. However this parameter is mainly due to loss inductance  $L_d$ , and load resistance  $R_c$ :

It is measured by means of a typical firing circuit which shows the current rise time to the secondary when an unipolar pulse is applied to the primary.

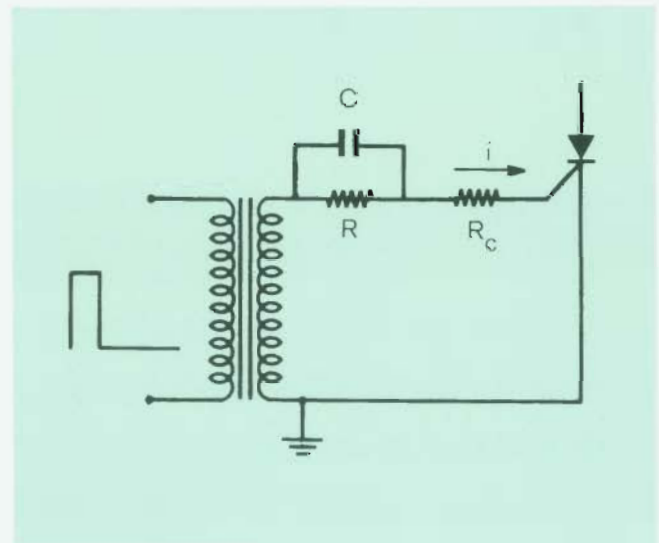

$t_s$  = pulse rise time ( $\mu\text{s}$ ).

$I_{\text{max}}$  = max available current at the secondary, with a rise time lower than  $1\mu\text{s}$ .

C)  $C_k$ : Coupling capacity between primary and secondary. A good magnetic coil coupling results to a too high capacitance causing unrequired firings. We must use a proper wire diameter, a correct winding number, coiling system and type of impregnation, in order to prevent unrequired firings. In this way a  $C_k$  can range within safety limits.

D) With the proximity of windings, the problem of insulation and of reliability must be taken into consideration: we solve this problem by choosing suitable materials (enamelled wire and impregnation), production techniques (wiring system and under vacuum casting). Under vacuum casting gives the component a long life.  $U_{is}$  = maximum working voltage between two single windings.

$U_p$  = test voltage (50 Hz) per 1 min (unrepeated)

$U_{gl}$  = minimum voltage (50 Hz) which, applied between two single windings, causes ionic interferences between them.

It must be higher than  $U_{is}$  to ensure the transformer life; the working voltage and possible repetitive overvoltages must not cause inner ionic disturbances having a periodical incidence, which, along with time, would damage the electric features of insulation. For this reason  $U_{gl}$  must be 1,5  $U_{is}$  minimum.

E) **Low losses**: SCR firing transformers operate with pulse current and high voltage. In windings, losses can be reduced keeping low ohmic values and choosing suitable materials for high frequency operations.

F) **Shell type and size**: no European standard exists. However most of our transformers can be replaced with others available on the market.

The case is made with self extinguishing thermoplastic material, following UL 94.

In the following tables electric and mechanical characteristics of our pulse transformers, standard type, are summarized.

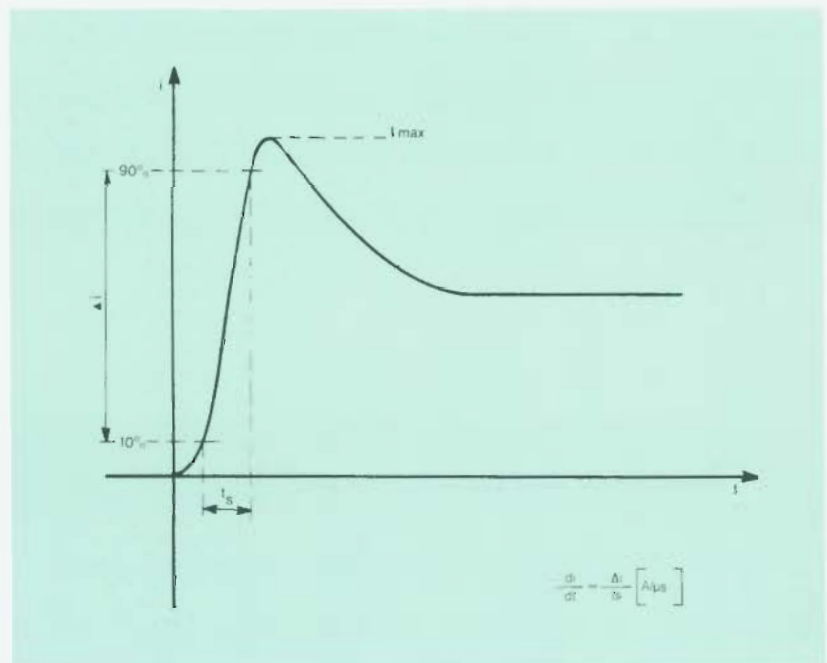

## NOTES:

$n$	Coil ratio between primary and secondary.
$\int u dt$	Minimum area «voltage-time» which can be transferred to secondary with unipolar pulses.
$L_p$	Primary inductance.
$C_k$	Coupling capacity between two windings.
$I$	Primary.
<b>II &amp; III</b>	Secondaries.
$R_{cl}$	Primary resistance.
$R_{cII}/R_{cIII}$	Resistance of each secondary.
$t_s$	Rise time of pulse to secondary with working current equal to $I_{\text{max}}$ .
$U_{is}$	Maximum working voltage between two single windings.
$U_p$	Unrepeated testing voltage (50 Hz) between two windings (1 min.).

# Single shot or multiple shot firing pulse transformers

Caratteristiche elettriche

Caracteristiques electriques

Electrical features

Caracteristicas electricas

Elektrischen Eigenschaften

**U<sub>is</sub> = 380V**

CODICE CODE	n	f <sub>udt</sub> (μVs)	t <sub>s</sub> (μs)	I <sub>max</sub> (mA)	R <sub>C</sub> (Ω)	L <sub>p</sub> (mH)	C <sub>k</sub> (pF)	R <sub>cul</sub> (Ω)	R <sub>cul-III</sub> (Ω)	U <sub>p</sub> (kV)	Core/ Raw Type / Material	Case	Schema
TI/111 010	1:1	200	<1	400	27	12	160	0,65	0,65	2	Toroidal/Ferrite	111	A
TI/111 020	1:1:1	200	<1	400	27	12	160	0,65	0,65	2	Toroidal/Ferrite	111	B
TI/111 030	1:1	200	<1	2000	10	2,5	110	0,4	0,4	2,5	Toroidal/Fe-Ni	111	A
TI/111 040	1:1:1	200	<1	2000	10	2,5	110	0,4	0,4	2,5	Toroidal/Fe-Ni	111	B
TI/112 010	1:1	300	<1	800	15	10	210	0,7	0,7	2,5	Toroidal/Ferrite	112	A
TI/112 020	1:1:1	300	<1	800	15	10	210	0,7	0,7	2,5	Toroidal/Ferrite	112	B
TI/112 030	1:1	500	<1	2000	15	4	150	0,5	0,5	2,5	Toroidal/Fe-Ni	112	A
TI/112 040	1:1:1	500	<1	2000	15	4	150	0,5	0,5	2,5	Toroidal/Fe-Ni	112	B
TI/112 045	2:1:1	400	<1	2000	10	9	130	0,8	0,4	2,5	Toroidal/Fe-Ni	112	B
TI/113 030	1:1	500	<1	2000	10	4,5	160	0,35	0,35	3,1	Toroidal/Fe-Ni	113	A
TI/113 040	1:1:1	500	<1	2000	10	4,5	160	0,35	0,35	3,1	Toroidal /Fe-Ni	113	B
TI/113 050	1:1	1000	<1	2000	10	5	190	0,4	0,4	3,1	Toroidal /Fe-Ni	113	A
TI/113 060	1:1:1	1000	<1	2000	10	5	190	0,4	0,4	3,1	Toroidal /Fe-Ni	113	B
TI/113 115	3:1:1	350	<1	2500	4,7	5	80	0,4	0,15	3,1	Toroidal /Fe-Ni	113	B
TI/113 119	3:1	350	<1	2500	4,7	5	80	0,4	0,15	3,1	Toroidal /Fe-Ni	113	A
TI/113 145	2:1:1	500	<1	2000	10	5	80	0,4	0,2	3,1	Toroidal /Fe-Ni	113	B
TI/114 050	1:1	1000	<1	1500	8	4	250	0,45	0,45	3,1	Toroidal /Fe-Ni	114	A
TI/114 060	1:1:1	1000	<1	1500	8	4	250	0,45	0,45	3,1	Toroidal /Fe-Ni	114	B
TI/114 065	2:1:1	1000	<1	2000	8	6	150	0,45	0,25	3,1	Toroidal /Fe-Ni	114	B
TI/114 070	1:1	2000	<1	2000	8	6	230	0,45	0,45	3,1	Toroidal /Fe-Ni	114	A
TI/114 080	1:1:1	2000	<1	2000	8	6	230	0,45	0,45	3,1	Toroidal /Fe-Ni	114	B

**U<sub>is</sub> = 500V**

CODICE CODE	n	f <sub>udt</sub> (μVs)	t <sub>s</sub> (μs)	I <sub>max</sub> (mA)	R <sub>C</sub> (Ω)	L <sub>p</sub> (mH)	C <sub>k</sub> (pF)	R <sub>cul</sub> (Ω)	R <sub>cul-III</sub> (Ω)	U <sub>p</sub> (kV)	Core/ Raw Type / Material	Case	Schema
TI/112 130	1:1	500	<1	2000	15	4	70	0,6	0,6	4	Toroidal/Fe-Ni	112	A
TI/112 140	1:1:1	500	<1	2000	15	4	70	0,6	0,6	4	Toroidal/Fe-Ni	112	B
TI/113 130	1:1	500	<1	2000	10	3,5	60	0,25	0,25	4	Toroidal/Fe-Ni	113	A
TI/113 140	1:1:1	500	<1	2000	10	3,5	60	0,25	0,25	4	Toroidal/Fe-Ni	113	B
TI/113 150	1:1	1000	<1	2000	10	5	100	0,4	0,4	5	Toroidal/Fe-Ni	113	A
TI/113 160	1:1:1	1000	<1	2000	10	5	100	0,4	0,4	5	Toroidal/Fe-Ni	113	B
TI/117 110	1:1	300	<1	750	15	3,5	35	0,8	0,8	4	EE/Ferrite	117	C
TI/117 120	1:1:1	300	<1	750	15	3,5	35	0,8	0,8	4	EE/Ferrite	117	D
TI/117 147	2:1	250	<1	1000	10	6	25	0,5	0,25	4	EE/Ferrite	117	C
TI/117 155	2:1:1	250	<1	1000	10	6	25	0,5	0,25	4	EE/Ferrite	117	D
TI/117 160	3:1	150	<1	2000	10	6	30	0,5	0,15	4	EE/Ferrite	117	C
TI/118 310	1:1	500	<1	1000	10	2,3	50	0,4	0,4	4	EE/Ferrite	118	E
TI/118 320	1:1:1	500	<1	1000	10	2,3	50	0,4	0,4	4	EE/Ferrite	118	F
TI/118 330	2:1:1	500	<1	1000	10	9	50	0,9	0,4	4	EE/Ferrite	118	F
TI/118 340	1:1	1000	<2	1000	20	9	50	0,7	0,8	4	EE/Ferrite	118	E
TI/118 350	1:1:1	1000	<2	1000	20	9	55	0,85	0,85	4	EE/Ferrite	118	F
TI/118 360	3:1	300	<1	1200	10	8,5	40	0,6	0,2	4	EE/Ferrite	118	E
TI/118 370	3:1:1	300	<1	1200	10	8,5	40	0,6	0,2	4	EE/Ferrite	118	F

111

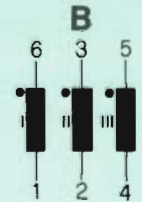
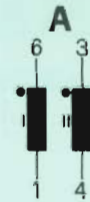
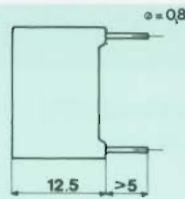
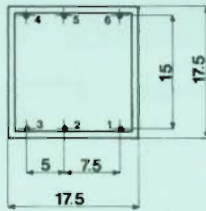

112

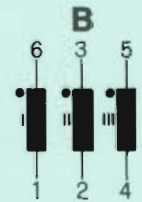
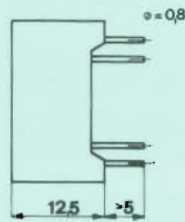
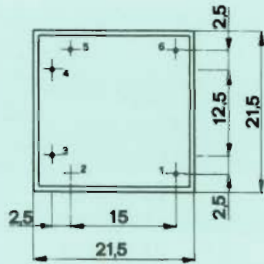

113

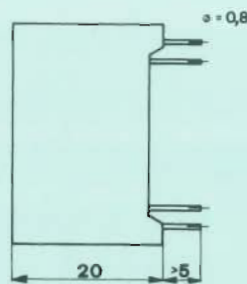
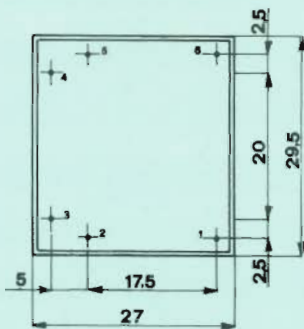

114

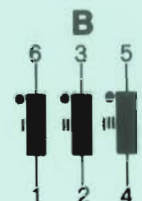
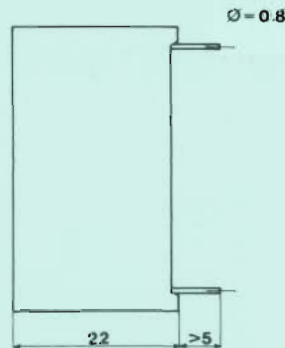
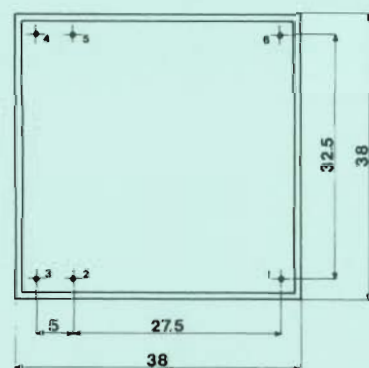

117

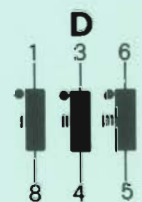
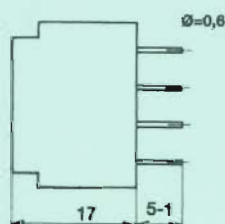
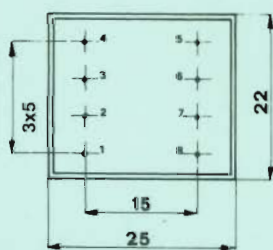

118

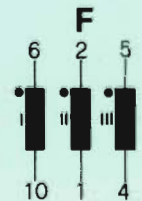
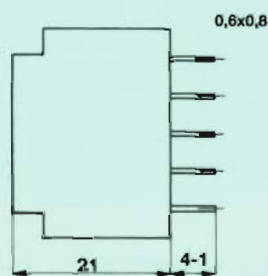
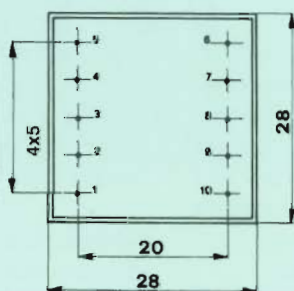

Scatola in materiale autoestinguente UL 94-HB; riempimento sottovuoto.

Boitier en matériel autoestinguible UL 94-HB; impregnation sous vide.

Box made with self extinguishing material UL 94-HB; vacuum filled.

Caja en material autoextinguible UL 94-HB; impregnada al vacio.

Gehäuse in selbstlöschenden materiell UL 94-HB; vergossen unter vakuum.

Le quote, espresse in mm, si intendano massime.

Les valeurs, exprimées en mm, s'entendent maximum.

Values, in mm, are maximum ones.

Los valores expresados en mm, son los máximos.

Die Angaben sind Maximalwerte in mm.

# Single shot or multiple shot firing pulse transformers

**Caratteristiche elettriche**

**Caracteristiques electriques**

**Electrical features**

**Caracteristicas electricas**

**Elektrischen Eigenschaften**

**Uis = 500V**

CODICE CODE	n	J <sub>udt</sub> (μVs)	t <sub>S</sub> (μs)	I <sub>max</sub> (mA)	R <sub>C</sub> (Ω)	L <sub>p</sub> (mH)	C <sub>K</sub> (pF)	R <sub>cul</sub> (Ω)	R <sub>cul-III</sub> (Ω)	U <sub>p</sub> (kV)	Core/ Raw Type/ Material	Case Schema
TI/108 001	1:1	500	3,0	100	100	8	10	1,8	1,8	4	EE/Ferrite	108 A
TI/108 002	2:1	200	0,8	100	100	7	8	1,8	0,9	4	EE/Ferrite	108 A
TI/108 010	1:1	250	1,5	250	40	2,5	7	0,65	0,65	3,1	EE/Ferrite	108 A
TI/108 020	1:1:1	250	1,5	250	40	2,5	7	0,65	0,65	3,1	EE/Ferrite	108 C
TI/108 021	1:1:1	200	1,4	250	40	1,6	5	0,50	0,5	3,1	EE/Ferrite	108 B
TI/108 022	1:1:1	250	1,8	250	40	2,5	7	0,65	0,65	3,1	EE/Ferrite	108 B
TI/108 030	2:1	350	3,5	250	40	19	8	3,8	1,1	3,1	EE/Ferrite	108 A
TI/108 040	2:1:1	350	3,5	250	40	19	8	3,8	1,1	3,1	EE/Ferrite	108 B
TI/108 050	3:1	300	2,5	250	40	21	8	5	0,7	3,1	EE/Ferrite	108 A
TI/108 060	3:1:1	300	2,5	250	40	21	8	5	0,7	3,1	EE/Ferrite	108 C
TI/110 143	1:1:1	800	1,0	25	400	10	10	3,5	3,5	4	EE/Ferrite	110 D
TI/110 144	3:1:1	800	1,0	25	400	110	10	17	3,5	4	EE/Ferrite	110 D
TI/110 145	1:1	800	1,0	25	400	10	10	3,5	3,5	4	EE/Ferrite	110 E
TI/110 153	1:1:1	600	1,2	100	100	7	8	1,5	1,5	4	EE/Ferrite	110 D
TI/110 154	3:1:1	600	1,2	100	100	65	7	7	1,5	4	EE/Ferrite	110 D
TI/110 155	1:1	500	1,0	100	100	5,5	7	1,1	1,1	4	EE/Ferrite	110 E
TI/110 233	1:1:1	300	1,2	250	40	2	7	0,55	0,55	4	EE/Ferrite	110 D
TI/110 234	3:1:1	300	1,0	250	40	15	7	2	0,55	4	EE/Ferrite	110 D
TI/110 235	1:1	300	1,0	250	40	2	6	0,55	0,55	4	EE/Ferrite	110 E
TI/110 239	1:1	350	2,0	250	40	2	5	0,6	0,6	10	EE/Ferrite	110 F

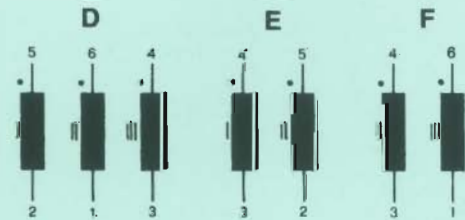
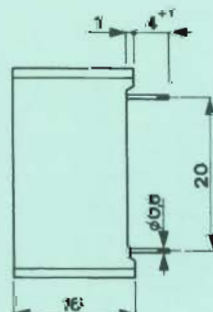
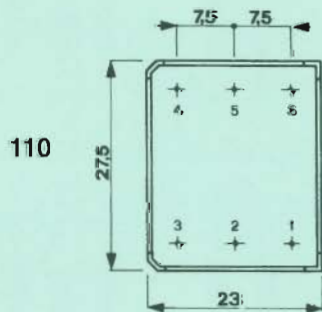
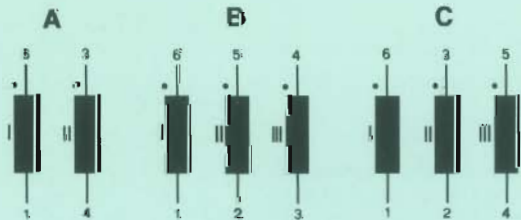
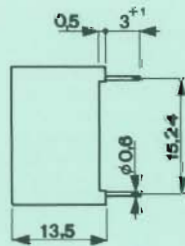
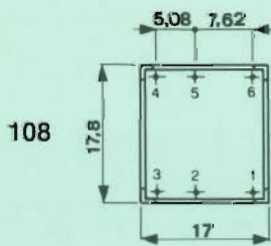

Scatola in materiale autoestinguente UL 94-HB; riempimento sottovuoto. Le quote sono espresse in mm.

Boîtier en matériel autoestinguible UL 94-HB; impregnation sous vide. Les valeurs sont exprimées en mm.

Box made with self extinguishing material UL 94-HB; vacuum filled. Values are in mm.

Caja en material autoextinguible UL 94-HB; impregnada al vacío. Valores expresados en mm.

Gehäuse in selbstlöschenden materiell UL 94-HB; vergossen unter vakuum. Abmessungen (mm).

# Single shot, large voltage-time area, firing pulse transformers

**Caratteristiche elettriche**

**Caracteristiques electriques**

**Electrical features**

**Características electricas**

**Elektrischen Eigenschaften**

**U<sub>is</sub> = 500V**

CODICE CODE	n	f <sub>udt</sub> (mVs)	t <sub>s</sub> (μs)	I <sub>max</sub> (mA)	R <sub>C</sub> (Ω)	L <sub>p</sub> (mH)	C <sub>k</sub> (pF)	R <sub>cul</sub> (Ω)	R <sub>cul-III</sub> (Ω)	U <sub>p</sub> (kV)	Core/ Type / Raw Material	Case	Schema
TI/118 010	2:1	2,5	≤1	1000	10	7	45	1	0,5	3,1	EE/Fe Si	118	E
TI/118 020	2:1	10	≤10	400	25	80	65	6	1,9	3,1	EE/Fe Si	118	E
TI/118 030	4:1	6	≤5	400	25	140	50	12	1,2	3,1	EE/Fe Si	118	E
TI/118 040	1,5:1	20	≤20	200	47	90	50	13	6,7	3,1	EE/Fe Si	118	E

**U<sub>is</sub> = 750V**

CODICE CODE	n	f <sub>udt</sub> (mVs)	t <sub>s</sub> (μs)	I <sub>max</sub> (mA)	R <sub>C</sub> (Ω)	L <sub>p</sub> (mH)	C <sub>k</sub> (pF)	R <sub>cul</sub> (Ω)	R <sub>cul-III</sub> (Ω)	U <sub>p</sub> (kV)	Core/ Type / Raw Material	Case	Schema
TI/119 010	4:1	5	≤2	400	25	35	40	3,6	0,45	5	EE/Fe Si	119	G
TI/119 020	2:1	5	≤2	400	25	27	40	1,5	0,40	5	EE/Fe Si	119	H
TI/119 030	2:1	10	≤5	400	25	55	50	3,6	0,80	5	EE/Fe Si	119	G
TI/119 040	4:1	2,5	≤1	400	25	27	50	1,5	0,20	5	EE/Fe Si	119	G

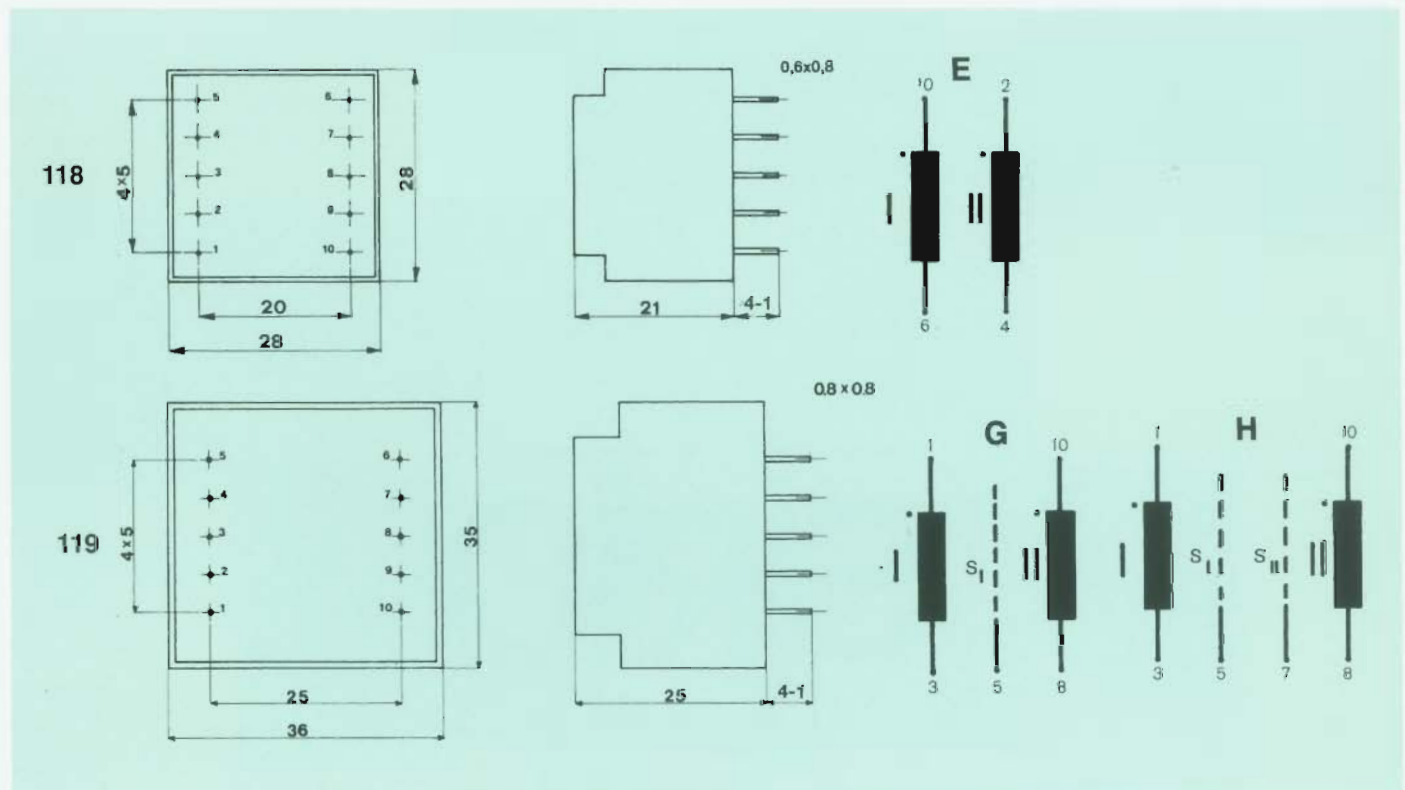

Scatola in materiale autoestinguente UL 94-HB; riempimento sottovuoto. Le quote sono espresse in mm.

Boîtier en matériel autoestinguible UL 94-HB; impregnation sous vide. Les valeurs sont exprimées en mm.

Box made with self extinguishing material UL 94-HB; vacuum filled. Values are in mm.

Caja en material autoextinguible UL 94-HB; impregnada al vacio. Valores expresados en mm.

Gehäuse in selbstlöschenden materiell UL 94-HB; vergossen unter vakuum. Abmessungen (mm).

S<sub>I</sub>: Schermo da collegare al primario.  
S<sub>II</sub>: Schermo da collegare al secondario.

S<sub>I</sub>: à connecter au primaire.  
S<sub>II</sub>: à connecter au secondaire.

S<sub>I</sub>: must be connected to primary winding.  
S<sub>II</sub>: must be connected to secondary winding

S<sub>I</sub>: Debe ser conectado con el primario.  
S<sub>II</sub>: Debe ser conectado con el secundario.

S<sub>I</sub>: Schirm zu Primärwicklung anschließen  
S<sub>II</sub>: Schirm zu Sekundärwicklung anschließen