

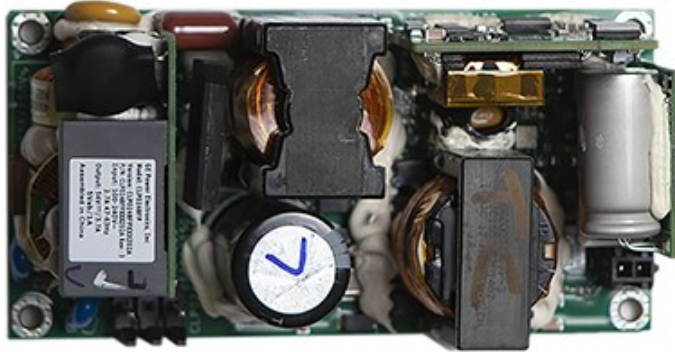

# CLP0248 Open Frame Power Supply

90 - 265Vac Input; 48V/4.16A or 54V/3.7A Output; 200W Output Power



In a small 2 x 4-inch footprint, the 48Vdc or 54Vdc single-output CLP0248 open frame power supply delivers greater than 88 percent typical power efficiency at 25 °C and full load output at +50 °C. With its small size, the CLP series is specifically designed to handle power challenges associated with tight space and low airflow.

## Description

Offering a leading 18W/in<sup>3</sup> power density in a 1U high, fan-less form factor, the CLP series addresses a broad range of applications in new products from industrial equipment and communications original equipment manufacturers (OEMs). Higher temperature operation is possible at derated output. The CLP series has zero voltage switching techniques in conjunction with quasi-resonant power factor. The design is suitable for PoE applications that require robust operation with good isolation, EMI/ESD immunity, various protection features (over voltage protection, over current protection, over temperature protection and input under voltage protection) and safety approvals. Applications include: Industrial Equipment | Telecommunications Equipment | SG Pico Base-Station

## Features

- Compact size 50.8 mm x 101.6 mm (2 in x 4 in x 1.40 in) with density of 18 W/in<sup>3</sup>
- Universal AC Input Range (90 ~ 265VAC permanently, 350VAC for 5 minutes)
- Output voltage of 48V or 54V with ±3V adjustable voltage
- Standby output of 5V/1A (5W)
- Standby power consumption of 0.5W (with no load on the standby output, and the main output inhibited)
- High efficiency (88% at Full Load, 230VAC in, 25 °C)
- Full load capability at 50 °C and 1m/s airflow with derating at higher temperatures or lower airflows
- Capable of >140W output in sealed enclosure applications, with enclosure ambient at 55 °C, and an enclosure internal temperature of 85 °C
- PoE compliant, output to Earth isolation of 2250Vdc
- Supports paralleling with active current sharing, as long as OR-ing components are added
- IEC61000-4-5, Level 4 (2kV/4kV)
- Output overcurrent protection (non-latching)
- Overtemperature and output over-voltage protections
- Up to 11ms of holdup time at 200W out (with Vout at 42V at the end)
- Active power factor corrected input
- Conducted EMI - meets CISPR22 (EN55022) and FCC Class B requirements
- Compliant to RoHS2 EU Directive 2011/65/EU
- UL and cUL approved to UL/CSA60950-1, TUV (EN60950-1), CE Mark (for LVD) and CB Report available
- ISO\*\* 9001 and ISO 14001 certified manufacturing facilities

See footnotes on page 4



# Technical Specifications

## Absolute Maximum Ratings

Stresses over the absolute maximum ratings can cause permanent damage to the device. Functional operation of the device is not implied at these or any other conditions over those given in the operations sections of the data sheet. Exposure to absolute maximum ratings for extended periods can adversely affect the device reliability.

Parameter	Device	Min	Max	Unit
Input Voltage - Continuous Operation	All	90	265	Vac
For up to 10 seconds operation	All	90	275	Vac
For up to 5 minutes, may not operate, no damage	All		305	Vac
Operating Ambient Temperature (see Thermal Considerations section)	All	-40	85	°C
Storage Temperature	All	-40	85	°C
Humidity (non-condensing)	All	5	95	%
Altitude	All		5000	m
Isolation Voltage—Input to output	All		3000	Vac
Input to safety ground	All		1500	Vac
Outputs to safety ground	All		2250	Vac

## Electrical Specifications

Parameter	Device	Min	Typ	Max	Unit
Operating Input Voltage	All	90	115/230	265	Vac
Input Source Frequency	All	47	50/60	63	Hz
Input Current ( $V_{IN} = 90\text{Vac}$ )	All			2.7	$A_{RMS}$
Input Power Factor (230Vac, Full Load)	All	0.95			
Inrush Transient Current ( $V_{IN} = 265\text{Vac}$ , $T_{amb} = 25^{\circ}\text{C}$ )	All			100	A Peak
Leakage Current to earth ground ( $V_{IN} = 265\text{Vac}$ )	All			3.5	mA
Output Voltage Adjustment Range	All	11.4		12.6	Vdc
Output Voltage Setpoint	201A		48		Vdc
	202A		54		Vdc
Output Voltage Tolerance (due to set point, temperature variations, load and line regulation)	All	-2		2	%
Output Voltage Adjustment Range	201A	45		51	Vdc
	202A	51		57	Vdc
Output Remote Sense Range—Total	All			1	Vdc
Output Load Regulation	All			1	%Vout
Output Line Regulation	All			0.25	%Vout
Output Ripple and Noise – measured with 0.1 $\mu\text{F}$ and 10 $\mu\text{F}$ capacitors in parallel. Peak-to-peak (20MHz Bandwidth) (higher for the 54V unit)	201A			500	mV p-p
	202A			550	mV p-p
Dynamic Load Response – 50% to 100% load transient, 1°/ $\mu\text{s}$ slew rate					
Output voltage deviation	All			2.4	V
Settling Time	All			2	Ms
Output Current	201A	0		4.16	Adc
	202A	0		3.7	Adc
Output Current Limit Inception	All	105		140	% $I_{O,max}$
Output Current Capacitance	All			1000	$\mu\text{F}$

-continued on next page-

See footnotes on page 4



# Technical Specifications (continued)

## Electrical Specifications con't.

Parameter	Device	Min	Typ	Max	Unit
Efficiency: $V_{IN} = 230V_{ac}$ —20% load ( $T_a = +25\text{ C}$ )	All	87.5			%
	All	92			%
	All	88			%
Efficiency: $V_{IN} = 115V_{ac}$ —20% load ( $T_a = +25\text{ C}$ )	All	87			%
	All	90			%
	All	87			%
Holdup Time <sup>1</sup> — 200W load	All	11			ms

## General Specifications

Parameter	Device	Symbol	Typ	Unit
Calculated Reliability based on Telcordia SR-332 Issue 2: Method 1 Case 3 ( $V_{IN}=230V_{ac}$ , $I_o = 3.7A$ , $T_A = 40^{\circ}C$ , airflow 200LFM, 90% confidence)	All	MTBF	>750,000	Hours
Weight	All		400	g
			14.1	oz.

## Feature Specifications

Parameter	Device	Min	Typ	Max	Unit
<b>On/Off Signal Interface – signal referenced to zero</b>					
<b>Logic Low (Power Supply ON)</b>					
Input Low Current	All			7	mA
Input Low Voltage	All			1	V
<b>Logic High (Power Supply OFF)</b>					
Input High Current	All			600	$\mu A$
Input Voltage	All			5.5	V
Delay from ON/OFF being enabled to start of output voltage rise	All			200	ms
Output Voltage Rise Time (from 10 to 90% of final value)	All		100		ms
Delay from Input being applied to all outputs being in regulation	All			800	ms
Output Overvoltage Protection	201A	59		64.5	Vdc
	202A	59		64.5	Vdc
<b>Input Undervoltage lockout<sup>2</sup></b>					
Turn-on Threshold (100% load)	All	75	81	90	Vac
Turn-off Threshold (100% load)	All	65	72	88	Vac
<b>DC OK – open collector, High when output available</b>					
Sink Current	All			4	mA
Maximum Collector Voltage	All			12	V

## Safety Specifications

Parameter	Device	Specification
Dielectric Withstand Voltage (between input and output)	All	Minimum of 4,250Vdc for 1 minute
Insulation Resistance (between input and output)	All	Minimum of 5 M $\Omega$
Safety Standards	All	Class 1, IEC60950, EN60950, with the following deviations: Nemko, UL 60950 (Recognized Component), cUL (Canadian Approval by UL)

See footnotes on page 4



# Technical Specifications (continued)

## Environmental Specifications

Parameter	Device	Specification
Radiated Emissions <sup>4</sup>	All	CISPR22 Class B with 3dB margin
Conducted Emission	All	CISPR22 Class B with 6dB margin
ESD	All	IEC 61000-4-2, Level 3
Radiated Susceptibility <sup>4</sup>	All	IEC 61000-4-3, Level 3
Electrical Fast Transient Common Mode	All	IEC 61000-4-4, Level 3
Surge Immunity	All	IEC 61000-4-5, Level 4
Conducted RF Immunity	All	IEC 61000-4-6, Level 3
Input Voltage Dips	All	Output stays within regulation for either ½ cycle interruption or 25% dip from nominal line for 1 second
Input Harmonics	All	IEC61000-3-2
Shock and Vibration	All	Per IPC-9592B, Class II

### FOOTNOTES

\*UL is a registered trademark of Underwriters Laboratories, Inc.

†CSA is a registered trademark of Canadian Standards Association.

\*\* ISO is a registered trademark of the International Organization of Standard

<sup>1</sup> Output voltage is allowed to drop to 42Vdc at the end of the hold-up period.

<sup>2</sup> Under-voltage lockout threshold may vary with output load current level – decreasing as load goes lower

<sup>3</sup> Output current sharing is controlled by an analogue signal referenced to Vout-. Best current sharing performance is achieved when the two output voltages are set very close to each other. Although the number of sharing units is limited to 2 in this document, more than two units may well share current adequately, but that is beyond the design intent, and beyond the development test plan. The units do not contain any output OR-ing device. **For units connected in parallel, the customer will have to add external output OR-ing devices.**

<sup>4</sup> Shall meet when tested in a suitable enclosure



# Technical Specifications (continued)

## Safety Considerations

The CLP0248 power supply is intended for inclusion in other equipment and the installer must ensure that it is in compliance with all the requirements of the end application. This product is only for inclusion by professional installers within other equipment and must not be operated as a stand-alone product. The power supply meets Class 1, IEC60950, EN60950, with the following deviations: Nemko. UL 60950 (Recognized Component) C-UL (Canadian Approval by UL). Input voltage can be up to 305Vac for up to 5 minutes.

Safety approval should include various input voltages, output currents, ambient temperatures, and cooling regimes. This should include 150W (or more) at 80C with conduction cooling. It should also include testing with the manufacturer's intended cover in place.

## Feature Descriptions

### Standby Power Supply

A standby output of 5V in the CLP0248 power supply, comes on when AC input in the operating range is applied.

### Remote On/Off

There is an On/Off control input. See the feature specification table for voltages and currents, and the pinout information table to find its location.

The main power supply turns ON when the Remote On/Off pin input goes low (such as connect HDR3.4 (Remote On/Off)) and HDR3.8 (Stand-by return)); turns OFF when the Remote On/Off pin goes high (such as connect HDR3.4 (Remote On/Off) and HDR3.7 (5V stand-by output)). Note that if the Remote On/Off pin is left unconnected, the power supply main output will remain off.

### Output Voltage Adjustment

The output voltage can be adjusted between 11.4V and 12.6V using a potentiometer on the power supply.

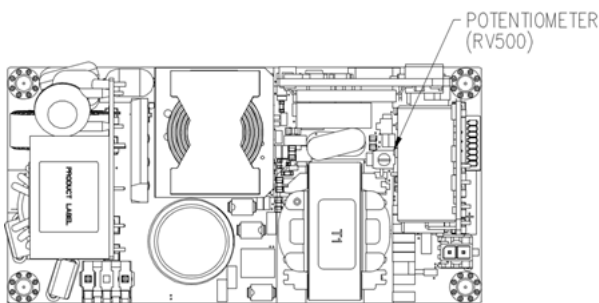

### Remote Sense

The power supply has both positive and negative remote sense connections that can be connected to the positive and negative rails of the main output near the load. The power supply operates without the remote sense connections being made.

### Overcurrent Protection

To provide protection in a fault condition (output overload), the power supply is equipped with internal current-limiting circuitry and can endure current limiting continuously. At the point of current-limit inception, the unit enters hiccup mode. The power supply operates normally once the output current is brought back into its specified range.

### Overvoltage Protection

Overvoltage protection is a feature of the CLP0212DC power supply that protects both the load and the power supply from an output overvoltage condition. When an overvoltage occurs, the power supply shuts down and goes into hiccup mode until the overvoltage condition is removed. It is not necessary to recycle the input to restart the power supply when this protection is activated.

### Overtemperature Protection

The CLP0248 also features overtemperature protection in order to provide additional protection in a fault condition. The power supply is equipped with a thermal shutdown circuit which detects excessive internal temperatures and shuts the unit down. Once the power supply goes into overtemperature shutdown, it will cool before attempting to restart. The overtemperature protection circuit will typically trip when the unit is operated at 200W output with an ambient temperature of 73°C and 1m/s (200LFM) airflow, when input voltage is 115Vac and 230Vac.

### Input Undervoltage Lockout

At input voltages below the input under-voltage lockout limit, power supply operation is disabled. The power supply will begin to operate at an input voltage above the under-voltage lockout turn-on threshold.

### DC OK

The power supply provides a DC OK signal that indicates when the main output is operating normally. This is an open-collector signal that goes high when the output is within regulation.

### Power Good LED

A green LED on board the power supply illuminates when the main output voltage is operating normally.

### Assembling

Metal screw should be used to mount the unit and 4 mounting holes are connected to Earth well.

### Thermal Considerations

The power supply can be operated in a variety of thermal environments; however sufficient cooling should be provided to ensure reliable operation.



# Technical Specifications (continued)

## Thermal Considerations con't

Considerations include: ambient temperature, presence of a cover, airflow, power supply dissipation and the need for increased reliability. A reduction in the operating temperature of the power supply will result in increased reliability. The thermal data presented here is based on measurements taken in a wind tunnel.

Low temperatures will adversely affect start-up. When the ambient temperature is in the range -40C to -15C the unit might not start up when the load is over 40% of rating. When the ambient temperature is above -15C and the input voltage is above 115Vac the unit will start up into full load.

## Heat Transfer via Convection

Increased airflow through the power supply enhances the heat transfer via convection. Figure below shows the preferred airflow direction. We will need derating data for airflow in other directions as well.

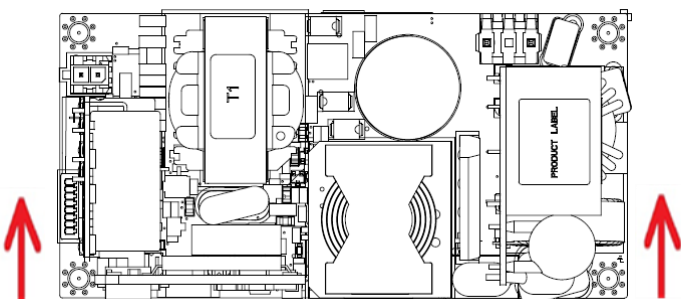

The below figure describes the available output current with the input voltage of 90Vac, 115Vac, 230Vac and 265Vac and with the airflow of 200LFM.

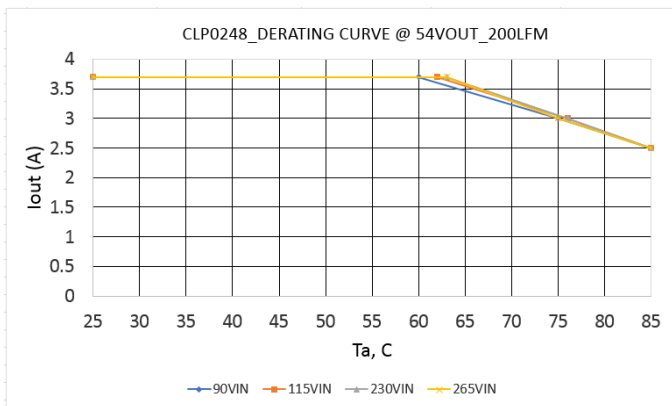

## Thermal Derating

CLP0248 can also be operated in a sealed enclosure provided proper means for removing heat from the power supply are used. Following Figure shows an arrangement where a thermally conductive pad is used to transfer heat from the bottom of the power supply into the

enclosure. Under such conditions, CLP0248 is capable of reduced power operation as shown in Table 1.

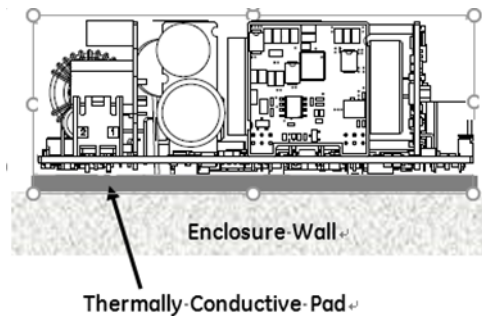

Note that the Ambient Temperature shown in Table 1 is that outside the sealed enclosure, the unit may see higher ambient temperatures.

Enclosure Outside temp	Enclosure inside temp	Max output power
25C	55C	190W
40C	70C	170W
50C	80C	150W
55C	85C	140W

Table 1 Below– Output power capability when the CLP0248 is operated in a sealed enclosure with a thermal pad for conduction cooling.

## Current Sharing

It is intended that 2 identical power supplies will current share. The current sharing is intended to produce a situation where the two power supplies, if identically cooled, will exhibit similar temperatures to each other.

The current sharing signal is referenced to Vout- so efforts must be made to keep the Vout- lines short and of low impedance and noise. The best current sharing performance will be achieved when the two output voltages are set very close to each other.

Although the number of sharing units is limited to 2, more than two units may well share current adequately. The units do not contain any output OR-ing device. If connection in parallel is required, the customer will have to add external output OR-ing devices.



# Technical Specifications (continued)

## Mechanical Outline (CLP0248)

Dimensions are in millimeters.

Tolerances: x.x mm ± 0.5mm [unless otherwise indicated] / x.xx mm ± 0.25mm

TOP VIEW

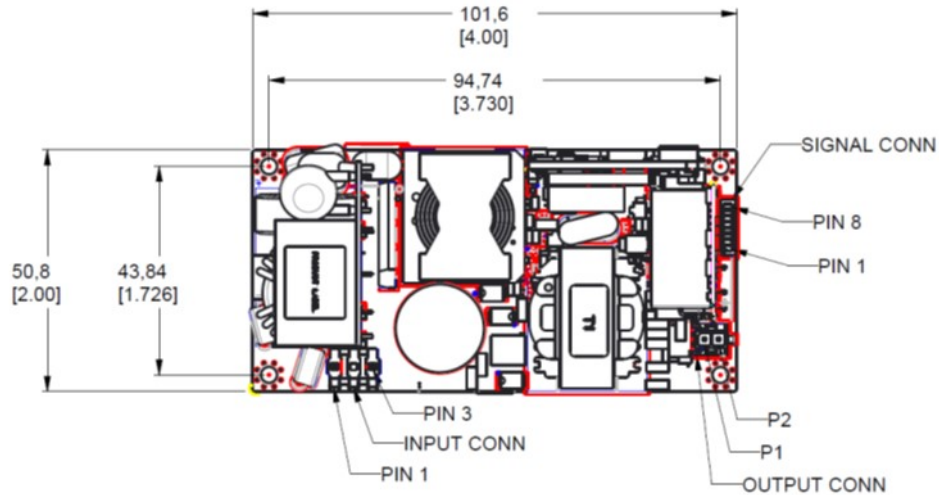

SIDE VIEW

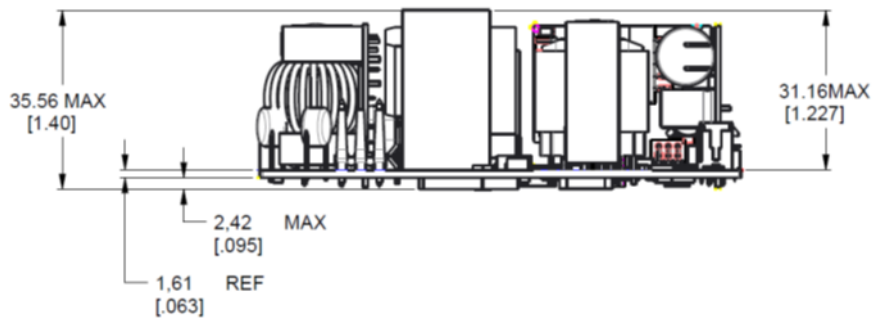

BOTTOM VIEW

minimum clearance of 6mm required on bottom of the unit

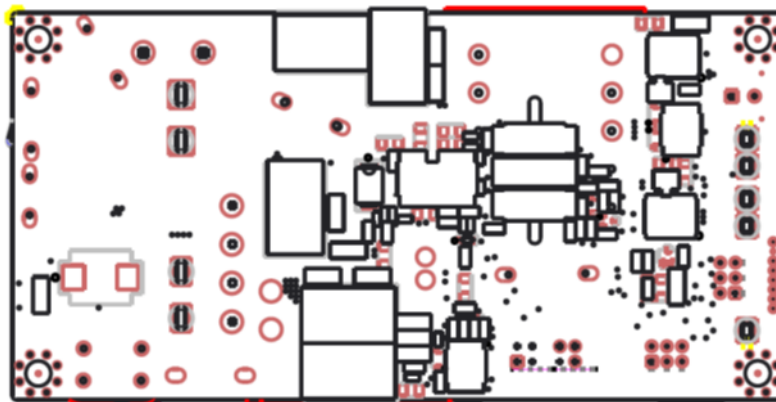

# Technical Specifications (continued)

## Drawings (CLP0248)

The CLP0248 is fastened to standard M3 pillars by standard M3 screws. We recommend a type with a captive anti-vibration washer, and here just as an example.

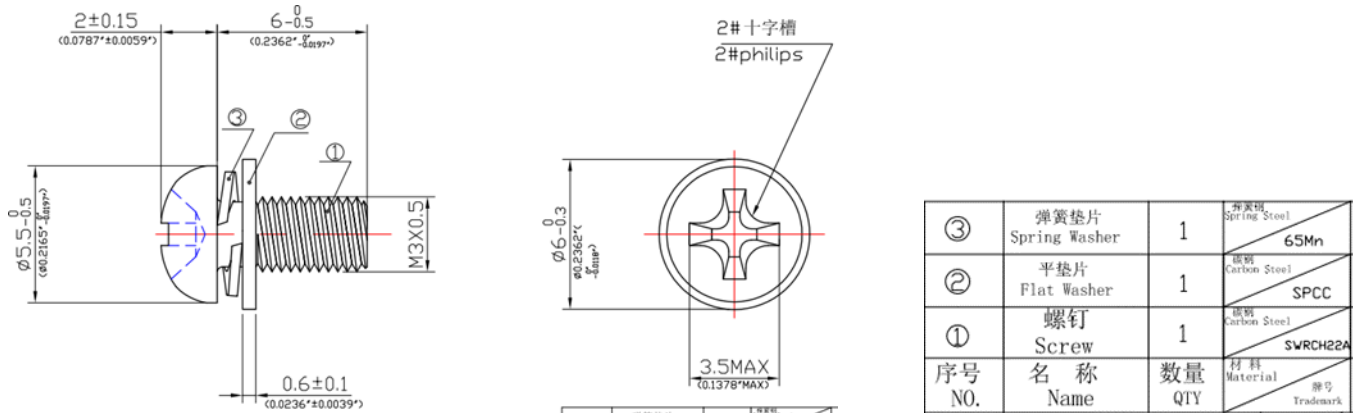

## Wiring Accessories

ABB offers a wiring kit, as per table 2 (Device Codes). Drawings to be provided by Engineering, in due course. And the leads of CLP0248 are similar to below.

Wire 1 – AC input – example of similar lead for illustration purposes only (CLP0248 lead uses positions 1 and 3, with 2 omitted for creepage and clearance purposes)

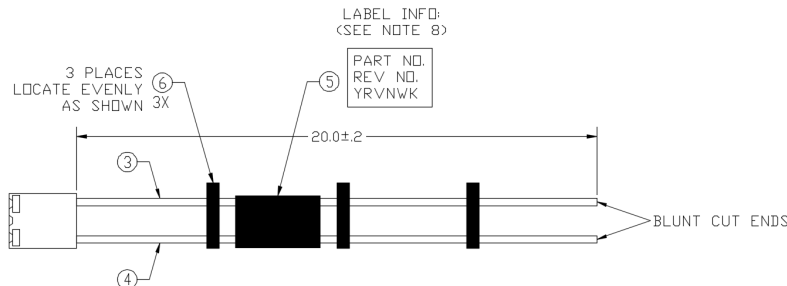

Wire 2 – DC Power output – example of similar lead for illustration purposes only

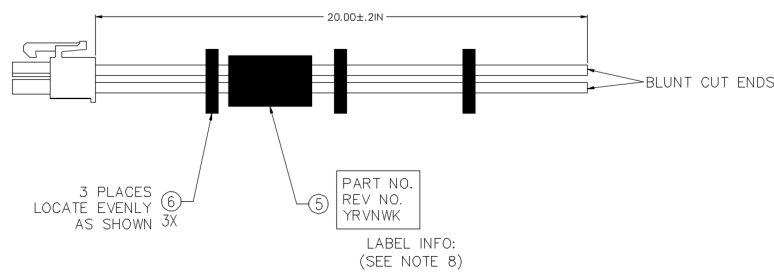

Wire 3 – Controls and Signals – example of similar lead for illustration purposes only

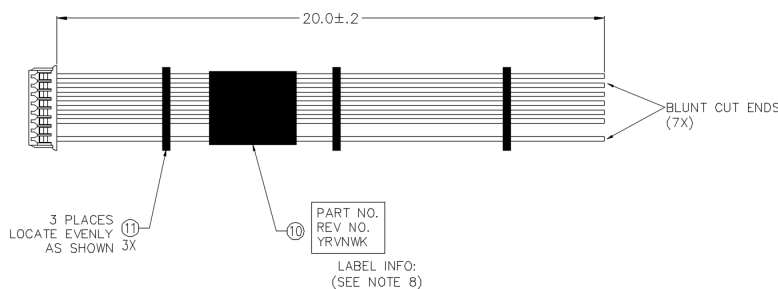





# Technical Specifications (continued)

## Cover Accessory

We will offer a cover, as per **Table 2-Device Codes**. (see next page). Here is an illustration of what it will look like.

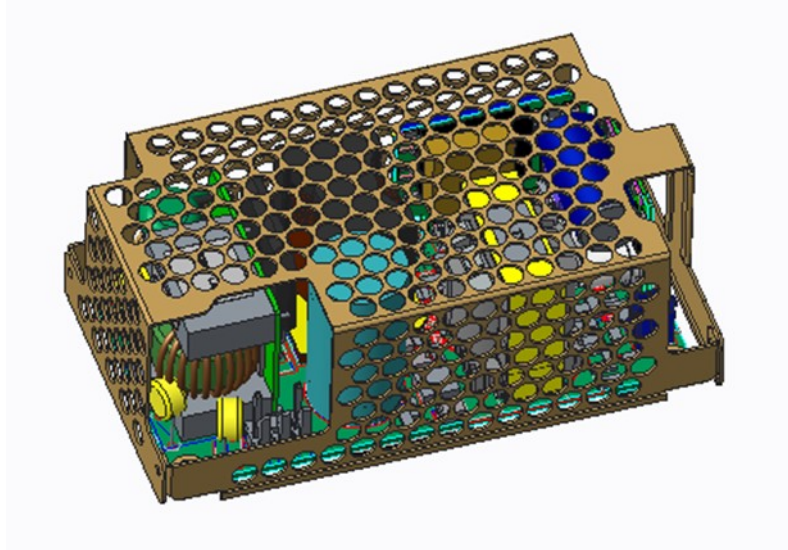

## Connector Information

Connector	Device	Min
AC Input Connector (HDR1)	Molex 26-50-3030	Molex 09-50-8030 (4600273521P) and 2 pieces of Molex 08-52-0071 (4600273523P)
DC Output Connector (HDR2)	CVILUX CP3502P1V00	CVILUX CP3502S0010 (4600273537P) and 2 pieces of CVILUX CP35TN2BPES (CC408630867 )
Auxiliary Connector (HDR3)	Molex 53047-0810	Molex 51021-0800 (450020704) and 8 pieces of Molex 50058-8000 (450021150)

## Pinout Information

AC Input Connector (HDR1)		DC Output Connector (HDR2)		Auxiliary (HDR3)	
Pin 1	Neutral	Pin 1	Vout Positive	1-Sense Positive	5-Current Share
Pin 2	Not used	Pin 2	Vout Negative	2-Unused	6-Output OK
Pin 3	Line			3-Sense Negative	7-SV Standby Output
				4-Remote On/Off	8-Stand-by Return

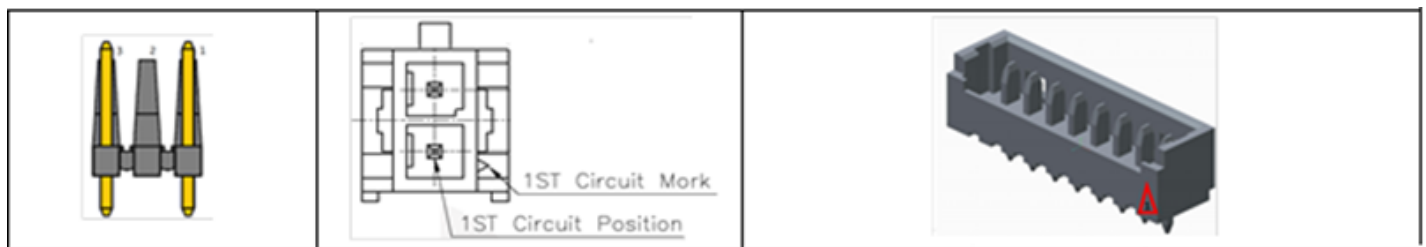



## Ordering Information

Device Code	Input Voltage Range	Output Voltage	Output Current	On/Off Control	Standby Supply	Temperature Range	Comcode
CLP0248FP XXXZ01A	90 – 265Vac	48Vdc	4.16A	Negative Logic	5V@0.25A	-40 to 85°C	CLP0248FPXXXZ01A
CLP0248FP XXXZ02A	90 – 265Vac	54Vdc	3.7A	Negative Logic	5V@0.25A	-40 to 85°C	CLP0248FPXXXZ02A
CLP0248CV RXXZ01A	Metal cover accessory	NA	NA	NA	NA	NA	CLP0248CVRXXZ01A
CLP0248CB LKTZ01A	50cm lead kit	NA	NA	NA	NA	-40 to 85°C	CLP0248CBLKTZ01A

**GE by ABB**

601 Shiloh Rd.  
Plano, TX USA

**Go.ABB/Industrial**

Ihr Vertriebspartner:



HY-LINE Power Components  
Vertriebs GmbH  
Inselkammerstr. 10  
D-82008 Unterhaching  
☎ +49 89/ 614 503 -10  
power@hy-line.de

HY-LINE AG  
Hochstrasse 355  
CH-8200 Schaffhausen  
☎ +41 52 647 42 00  
info@hy-line.ch



**Industrial  
Solutions**

We reserve the right to make technical changes or modify the contents of this document without prior notice. With regard to purchase orders, the agreed particulars shall prevail. GE by ABB does not accept any responsibility whatsoever for potential errors or possible lack of information in this document.

We reserve all rights in this document and in the subject matter and illustrations contained therein. Any reproduction, disclosure to third parties or utilization of its contents – in whole or in parts – is forbidden without prior written consent of GE by ABB

Copyright© 2020 ABB  
All rights reserved