



Medical



Industrial



Test



Comm



Broadcast

Single Output 200 to 250W Medical & ITE Power Supplies

Features	Benefits
• IEC 60601-1 (2x MOPP) & IEC 60950-1 Approvals	• Suitable for B & BF type Medical and ITE Applications
• 200W Convection cooled rating	• No fan noise, good for noise-sensitive environments
• Low profile (34 mm), Standard 3"x5" format	• Space saving & easy system integration
• 5V Standby power supply on board	• No additional circuitry needed, saves cost
• Operating Altitude up to 5000m	• Supports global use & global sales of equipment
• High Efficiency up to 94 %, Low off-load power consumption (<0.5W)	• Excellent "environmental footprint"



Specification		CUS200M
Model		
AC Input Voltage	VAC	85 - 265VAC (1)
Input Frequency	Hz	47 - 63Hz
Inrush Current (cold start)	A	35A at 115VAC, 70A at 230VAC
Power Factor	-	Meets EN61000-3-2 Class A (Typical PF 0.99/0.95) (2)
Input Current (115/230VAC)	A	200W output: 2.2 / 1.1A; 250W output: 3.0 / 1.5A
Off-load Power Consumption (3)	W	<0.5W at 230VAC
Temperature Coefficient	%/°C	<0.02%/°C
Overcurrent Protection	-	12V: >17.2A, 18V: > 14.7A, 24V: > 11A, 36V: > 7.4A, 48V: > 5.5A
Overvoltage Protection (4)	V	12V: 13.2 - 16.2V, 18V: 19.8 - 24.3V, 24V: 26.4 - 32.4V, 36V: 39.6 - 48.6V, 48V: 52.8 - 64.8V
Hold Up Time (115 / 230V input)	ms	16ms at 200W output, 12ms at 250W
Leakage Current	mA	<0.3mA at 265VAC, 60Hz
Remote On/Off	-	Apply voltage to isolated terminals to shut unit down
Power Good	-	Isolated transistor, On = Good. Gives >5ms warning of AC power loss
Standby Voltage	-	5V 0.6A (convection), 1A (forced air)
Operating Temperature	°C	-20°C to +70°C. Derate linearly to 50% load from +50°C to +70°C
Storage Temperature	°C	-40°C to +85°C
Humidity (non condensing)	%RH	10 - 95%RH (Operating & Storage)
Cooling	-	Convection or Forced Air Cooled (1.5m/s across terminals)
Withstand Voltage	-	Input to Ground 2kVAC (1xMOPP), Input to Output 4kVAC (2xMOPPs), Output to Ground 1.5kVAC (1xMOPP) Suitable for B and BF rated medical equipment
Isolation Resistance	Ω	>100MΩ at 25°C & 70%RH, Output to Ground 500VDC
Vibration (non operating)	-	10 - 55Hz: 19.6m/s ² constant sweep 1 min X, Y, Z for 1 hour
Shock	-	< 196.1 m/s ² (20G)
Immunity	-	IEC61000-4-2 (lv 2, 3), -3 (lv3), -4 (lv 3), -5 (lv3, 4), -6 (lv 3), -8 (lv 4), -11, EN60601-1-2:2015 (Ed4)
Safety Agency Certifications	-	IEC/UL/ES/CSA/EN60601-1, IEC/UL/CSA/EN62368-1, 60950-1, CE Mark
Conducted & Radiated EMI	-	EN55011-B, FCC Class B
Weight (Typ)	g	350
Size (LxWxH)	mm	127 x 76.2 x 34
Warranty	yrs	3

Notes:

- (1) Derate linearly to 80% load from 115 to 85VAC input
- (2) 115 / 230VAC input
- (3) Refers to input power during remote off and standby 5V in at no load condition
- (4) Cycle AC to reset

Model Selector

Model	Voltage	Adjust Range (V)	Max Current Conv (A)	Max Current Forced Air (A)	Max Power Forced Air (W)	Load Reg (mV)	Line Reg (mV)	Ripple Noise (mV)	Efficiency (typical) % ⁽⁵⁾
CUS200M-12	12V	11.7 - 12.6	16.7	16.7	200.4	120	60	180	92 / 93
CUS200M-18	18V	17.6 - 18.9	11.2	14.0	252.0	180	90	180	92 / 94
CUS200M-24	24V	23.5 - 25.2	8.4	10.5	252.0	240	120	240	92 / 94
CUS200M-36	36V	35.2 - 37.8	5.5	7.0	252.0	360	180	360	92 / 94
CUS200M-48	48V	47 - 50.4	4.2	5.3	254.4	480	240	480	92 / 94

Notes:(5) 115 / 230VAC input with convection cooling

Options (available on request)

blank	Standard model
Suffix "/A"	Cased model with chassis & cover
Suffix "/L"	L bracket, no cover

Outline Drawing CUS200M Series

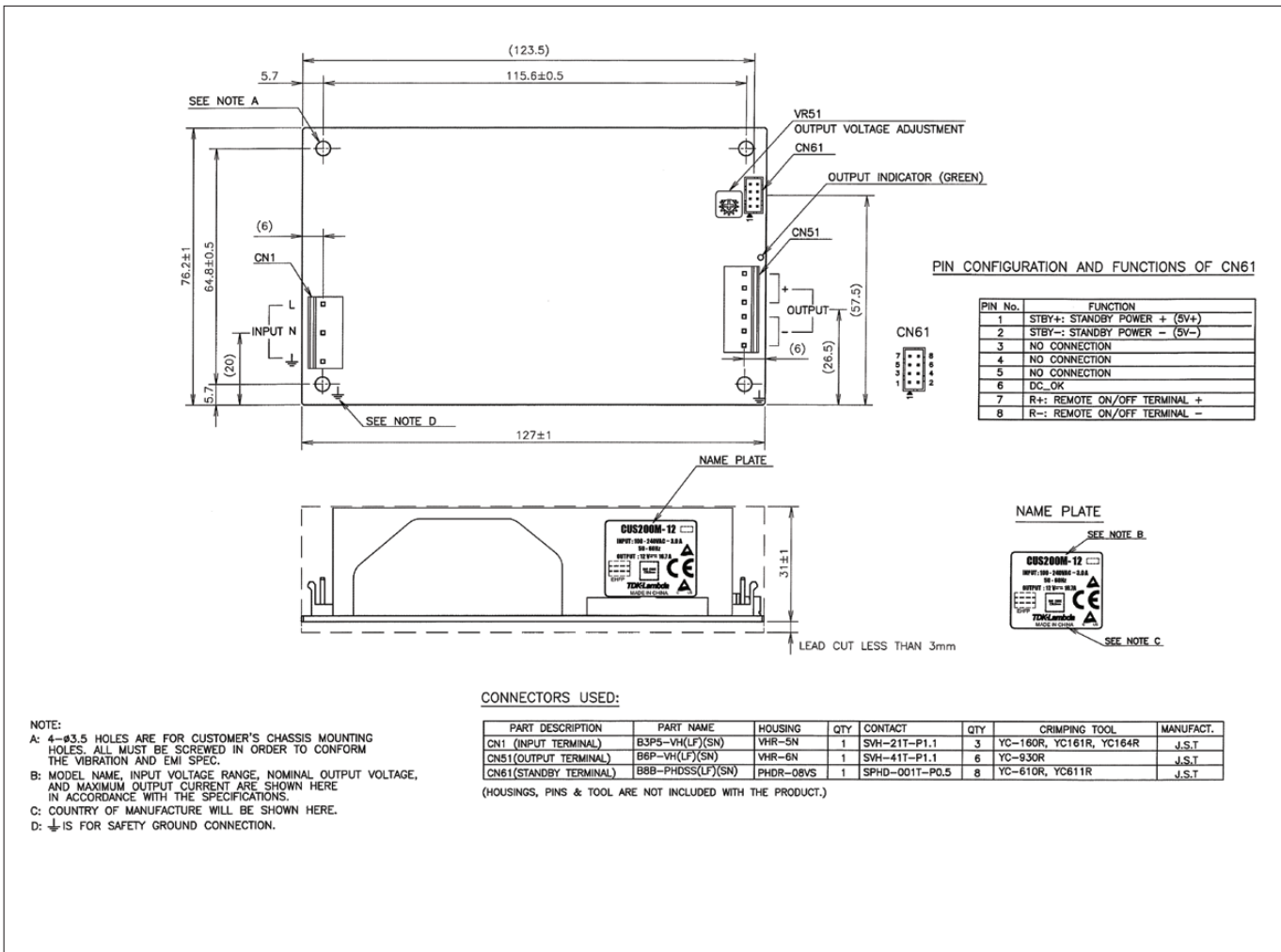

Notes: For detailed Instruction Manual, Cooling, Reliability Data, Electrolytic capacitor Lifetime data, Application advice like Mounting options, relevant Derating curves etc. please refer to "Technical Downloads" or contact factory for support

Output Derating according to the Mounting Direction

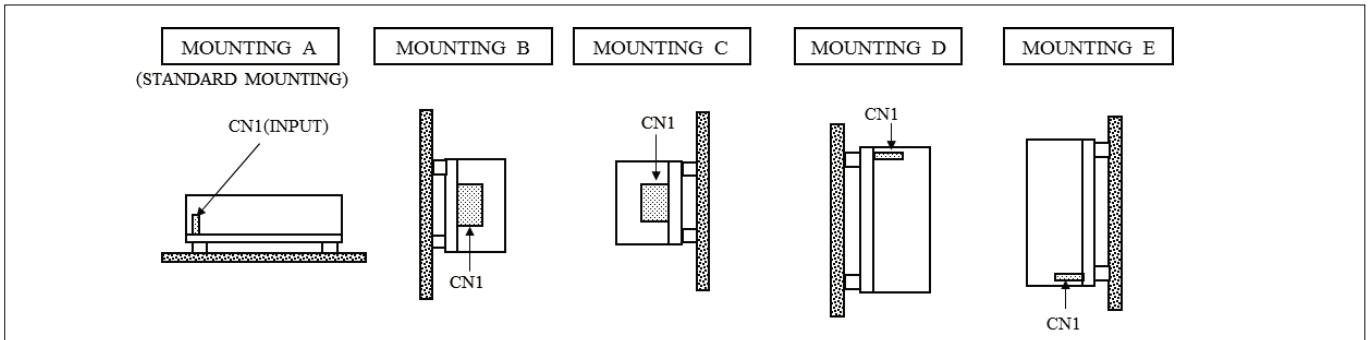

Output Derating CUS200M-12

MODEL: CUS200M-12

Ta (°C)	MOUNTING A,B	MOUNTING C,D	MOUNTING E (NOTE1)
	LOAD (%)	LOAD (%)	LOAD (%)
-20 - +40	100	100	100
50	100	80	80
60	75	60	60
65	63	50	-
70	50	40	-

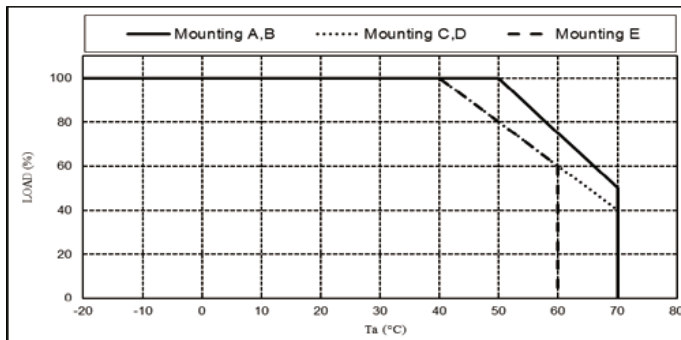

Output Derating CUS200M-18, CUS200M-24, CUS200M-36, CUS200M-48

MODEL: CUS200M-18, CUS200M-24, CUS200M-48

Ta (°C)	MOUNTING A,B	MOUNTING C,D	MOUNTING E (NOTE1)
	LOAD (%)	LOAD (%)	LOAD (%)
-20 - +40	100	100	100
50	100	80	100
60	75	60	75
65	63	50	-
70	50	40	-

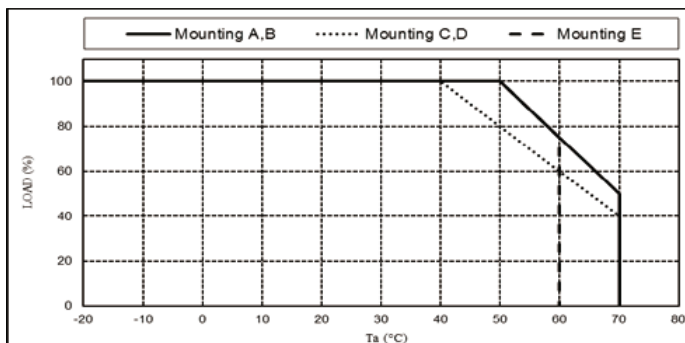

Outline Drawing CUS200M/A Series

CONNECTORS USED:

PART DESCRIPTION	PART NAME	HOUSING	QTY	CONTACT	QTY	CRIMPING TOOL	MANUFACT.
CN1 (INPUT TERMINAL)	B3PS-VH(LF)(SN)	VHR-5N	1	SVH-21T-P1.1	3	YC-160R, YC161R, YC164R	J.S.T
CN51(OUTPUT TERMINAL)	B6P-VH(LF)(SN)	VHR-6N	1	SVH-41T-P1.1	6	YC-930R	J.S.T
CN61(STANDBY TERMINAL)	B8B-PHDS(LF)(SN)	PHDR-08VS	1	SPHD-001T-P0.5	8	YC-610R, YC611R	J.S.T

(HOUSINGS, PINS & TOOL ARE NOT INCLUDED WITH THE PRODUCT.)

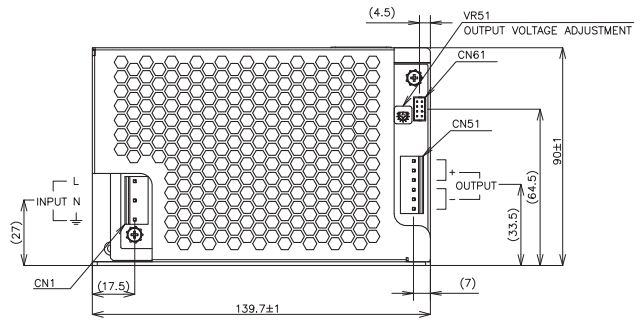
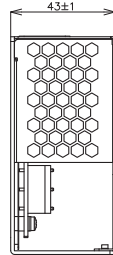
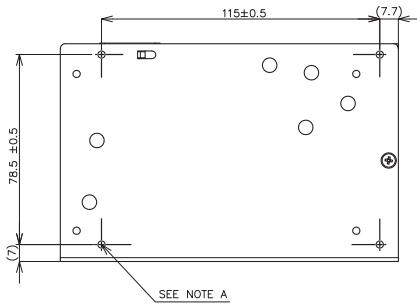
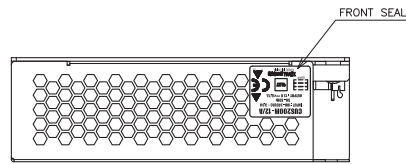

FRONT SEAL
SCALE 1:1

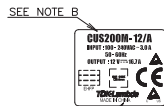

PIN CONFIGURATION AND FUNCTIONS OF CN61



PIN No.	FUNCTION
1	STBY+: STANDBY POWER + (5V+)
2	STBY-: STANDBY POWER - (5V-)
3	NO CONNECTION
4	NO CONNECTION
5	NO CONNECTION
6	DC_OK
7	R+: REMOTE ON/OFF TERMINAL +
8	R-: REMOTE ON/OFF TERMINAL -

NOTE:

A: 4-M3 TAPPED HOES ARE FOR CUSTOMER'S CHASSIS MOUNTING HOLES. ALL MUST BE SCREWED IN ORDER TO CONFORM THE VIBRATION AND EMI SPEC. (SCREW PENETRATION DEPTH 4mm MAX.)

B: MODEL NAME, INPUT VOLTAGE RANGE, NOMINAL OUTPUT VOLTAGE, AND MAXIMUM OUTPUT CURRENT ARE SHOWN HERE IN ACCORDANCE WITH THE SPECIFICATIONS.

C: COUNTRY OF MANUFACTURE WILL BE SHOWN HERE.

D: ⚡ IS FOR SAFETY GROUND CONNECTION.

(unit : mm)

MODEL NAME	CUS200M/A
TDK-Lambda	
CAB11-02-01/A-A	

Output Derating CUS200M/A

Ta (°C)	MOUNTING A,B	MOUNTING C,D	MOUNTING E
	LOAD (%)	LOAD (%)	LOAD (%)
-20 ~ +25	100	100	100
35	100	82	82
45	80	65	65
50	70	57	57
55	60	48	48
60	50	40	-

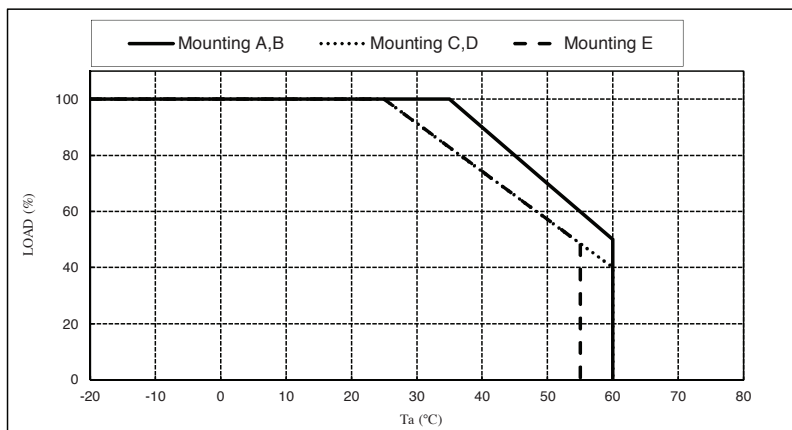

Output Derating versus Operating Ambient Temp (Ta) CUS200M/A

* Cooling: Forced Air Cooling for all Mounting and all Models

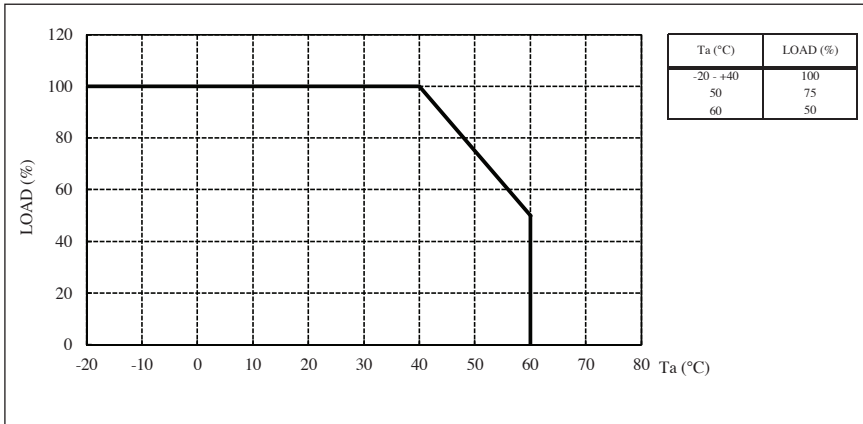

Output Derating versus Input Voltage (all Models)

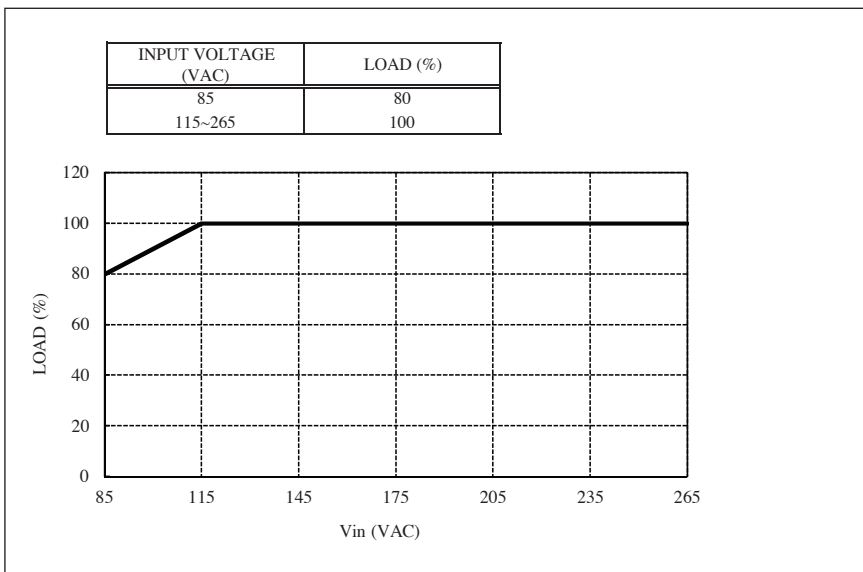



TDK-Lambda France SAS

3 Avenue du Canada
Parc Technopolis
Bâtiment Sigma
91940 les Ulis
France
Tel: +33 1 60 12 71 65
Fax: +33 1 60 12 71 66
france@fr.tdk-lambda.com
www.emea.lambda.tdk.com/fr



Italy Sales Office

Via Giacomo Matteotti 62
20092 Cinisello Balsamo (MI)
Italy
Tel: +39 02 61 29 38 63
Fax: +39 02 61 29 09 00
info.italia@it.tdk-lambda.com
www.emea.lambda.tdk.com/it



Netherlands

info@nl.tdk-lambda.com
www.emea.lambda.tdk.com/nl



TDK-Lambda Germany GmbH

Karl-Bold-Strasse 40
77855 Achern
Germany
Tel: +49 7841 666 0
Fax: +49 7841 5000
info.germany@de.tdk-lambda.com
www.emea.lambda.tdk.com/de



Austria Sales Office

Aredstrasse 22
2544 Leobersdorf
Austria
Tel: +43 2256 655 84
Fax: +43 2256 645 12
info@at.tdk-lambda.com
www.emea.lambda.tdk.com/at



Switzerland Sales Office

Eichtalstrasse 55
8634 Hombrechtikon
Switzerland
Tel: +41 44 850 53 53
Fax: +41 44 850 53 50
info@ch.tdk-lambda.com
www.emea.lambda.tdk.com/ch



Nordic Sales Office

Haderslevvej 36B
DK-6000 Kolding
Denmark
Tel: +45 8853 8086
info@dk.tdk-lambda.com
www.emea.lambda.tdk.com/dk



TDK-Lambda UK Ltd.

Kingsley Avenue
Ilfracombe
Devon EX34 8ES
United Kingdom
Tel: +44 (0) 12 71 85 66 66
Fax: +44 (0) 12 71 86 48 94
info@uk.tdk-lambda.com
www.emea.lambda.tdk.com/uk



TDK-Lambda Ltd.

1 Alexander Yanai
Segula
Petah-Tikva
Israel
Tel: +9 723 902 4333
Fax: +9 723 902 4777
info@tdk-lambda.co.il
www.emea.lambda.tdk.com/il



C.I.S.

Commercial Support:

Tel: +7 (495) 665 2627

Technical Support:

Tel: +7 (812) 658 0463

info@tdk-lambda.ru

www.emea.lambda.tdk.com/ru

Local Distribution

Ihr Vertriebspartner:



HY-LINE Power Components
Vertriebs GmbH
Inselkammerstr. 10
D-82008 Unterhaching
☎ +49 89/ 614 503 -10
power@hy-line.de

HY-LINE AG
Hochstrasse 355
CH-8200 Schaffhausen
☎ +41 52 647 42 00
info@hy-line.ch