



Actual Size

# BIAS Power Supply Module BPS 1 Series Data Sheet

The BPS 1 Power Supply Module is an ideal replacement for current standby power applications in appliances and consumer electronics. Also appropriate for low-power industrial and commercial applications. This low-cost supply provides up to one watt of output power at 8 or 14 VDC (Vo) and an optional 5 VDC (Vr) output to power standby functions such as a clock, microprocessor or remote control sensor. Incorporating a custom integrated circuit into a small package (0.5 in<sup>3</sup> [8.0 cm<sup>3</sup>]) the BIAS Module provides an immediate “drop-in” solution, requiring no additional external components.

## Features

- **Universal Input (85-265 VAC, 50/60Hz)**
- **Small Size—0.5in<sup>3</sup> [8.0cm<sup>3</sup>]**
- **Single Component Solution**
- **Very low no-load input power <30mW**
- **3000 VAC Isolation**
- **Up to 75% efficiency**
- **EN 55022, Class B; FCC Part 15, Class B**
- **Meets UL/CSA and EN Product Safety Requirements (ITE)**

## Operating Specifications

(@120VAC / 60 Hz / 25°C unless otherwise specified)



Electrical	
Input Voltage Range	85 - 265 VAC (50/60Hz)
Input Surge Withstand	308V, < 30 sec
Output Power (Pmax)	1 W min. (60Hz) 0.83 W min. (50Hz)
Efficiency	75% nom.
Output Vo (Peak)	8 or 14 VDC nom. +/- 5%
Line / Load Regulation Vo (Peak)	+/- 1% Po < Pmax
Temperature Regulation Vo (Peak)	+/- 2% Po < Pmax
Ripple Vo (@ 120 Hz) (@ 100 kHz)	1.75 V p:p 0.25 V p:p
Output Vr	5 VDC +/- 5%, Ir out 100mA max Iout + Ir out <= 125mA
No-load Consumption	30 mW typical @ Vin=120 VAC
Isolation	3000 VAC (meets UL / CSA & EN Product Safety)
Earth Leakage @ 120 VAC	< 10 uA
Short Circuit Protection	Continuous, Pin = 0.7 w @ Vin = 120 VAC
Reliability @ 25° C	> 200 Khr MTBF
Thermal	
Operating Temperature	0 to 70° C
Operating Relative Humidity	0 – 95%, non-condensing
Storage Temperature	-40 to 105° C
Mechanical	
Package Size (L x W x H)	1.03 x 0.89 x 0.53 inches [26.2 x 22.6 x 13.5 mm]
Safety	
Safety Compliance <sup>2</sup>	UL / EN 60950 (CB Report Available)
EMI Emissions	EN 55022, Class B, FCC Part 15, Class B

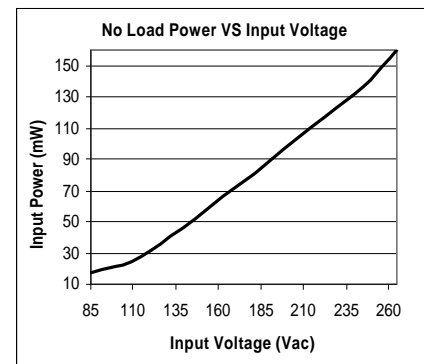



# BIAS Power Supply Module BPS 1 Series Data Sheet

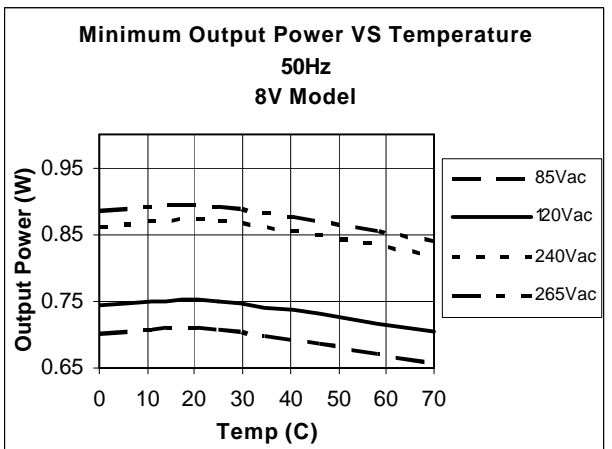
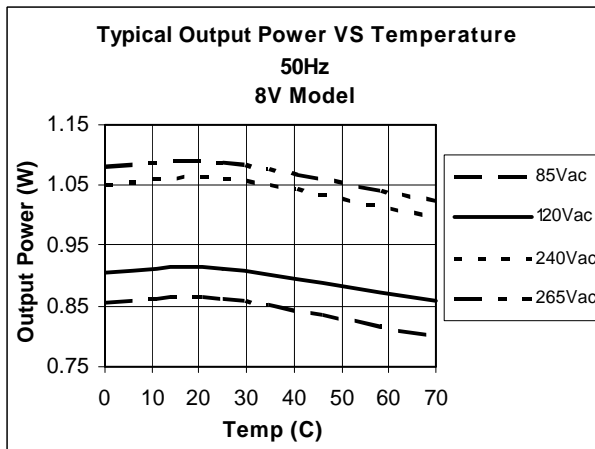
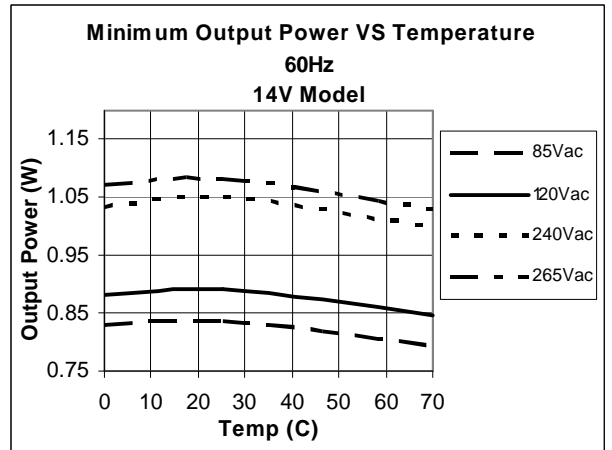
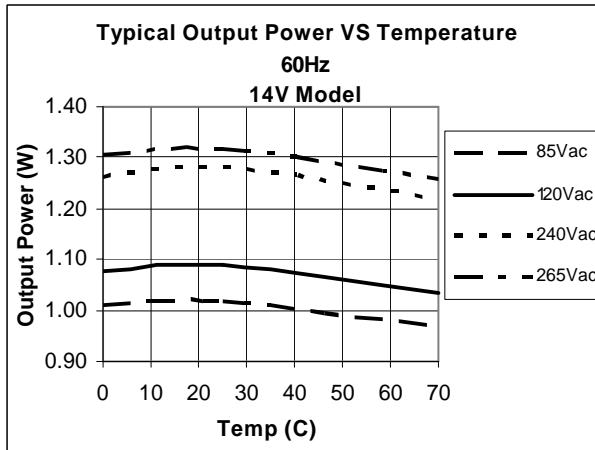
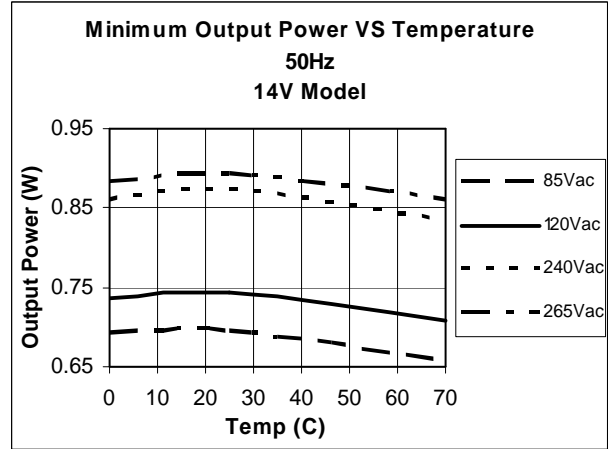
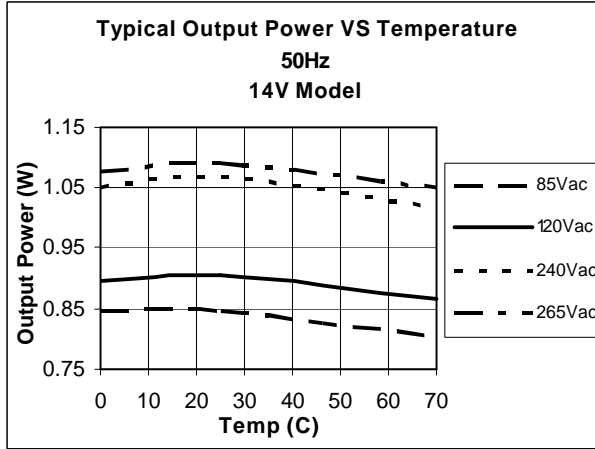



# BIAS Power Supply Module

## BPS 1 Series Data Sheet

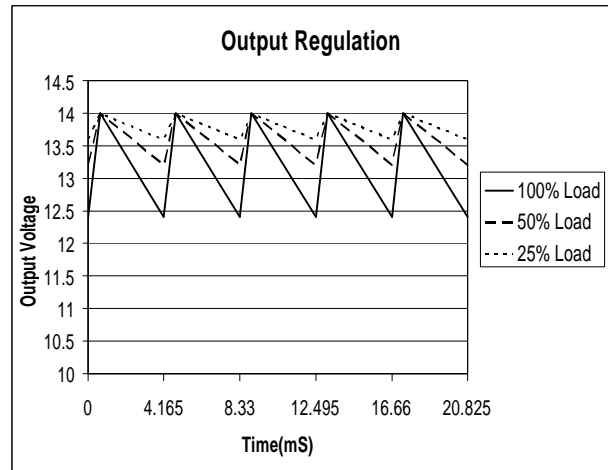
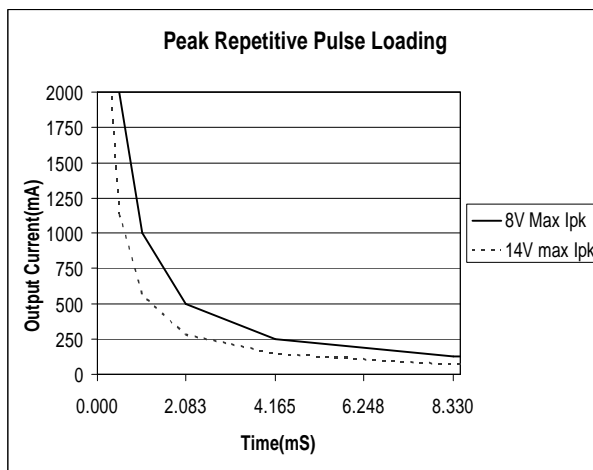
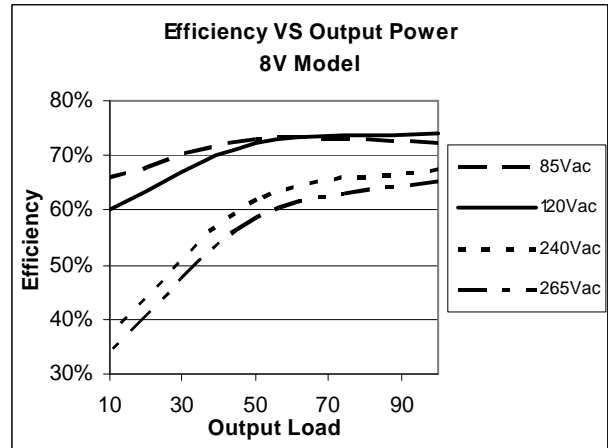
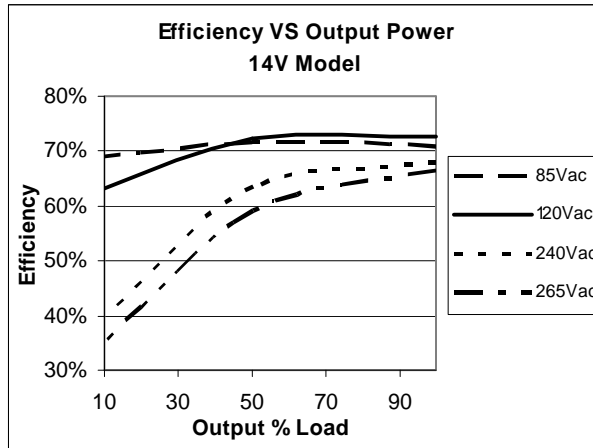
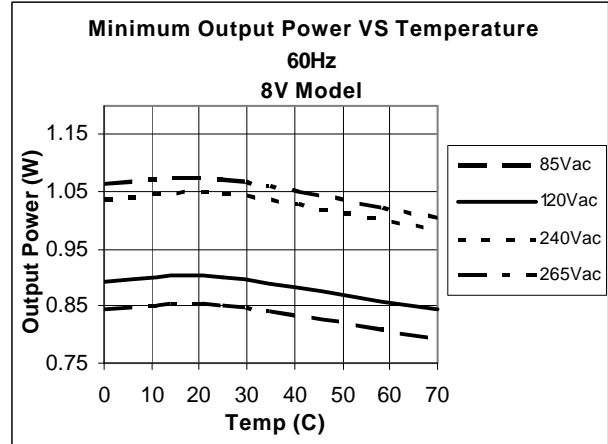
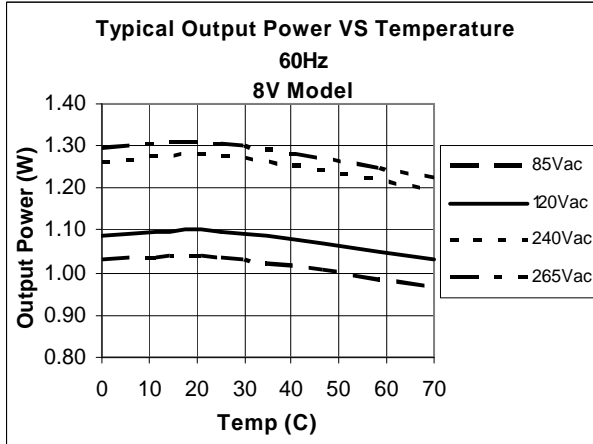



# BIAS Power Supply Module BPS 1 Series Data Sheet

## Part Number Designation

Part Number	Output Configuration	Vo	Vr
BPS 1-08-00	Single output	8 VDC	N/A
BPS 1-14-00	Single output	14 VDC	N/A
BPS 1-08-50	Dual Output	8 VDC	5 VDC

For custom configurations, contact BIAS Power.

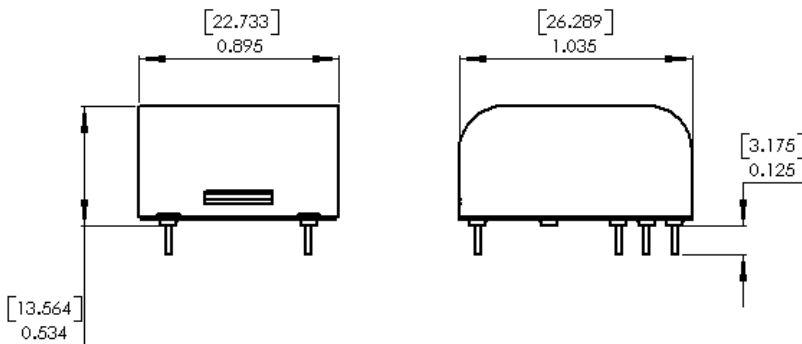

PIN DESIGNATOR	DESCRIPTION
L1	Input High
L2	Input Low
N/C	No Connection
Vo	Output
GND	Ground
Vr	Vr Output
N/C	No Connection

## Recommended Land Pattern, top view

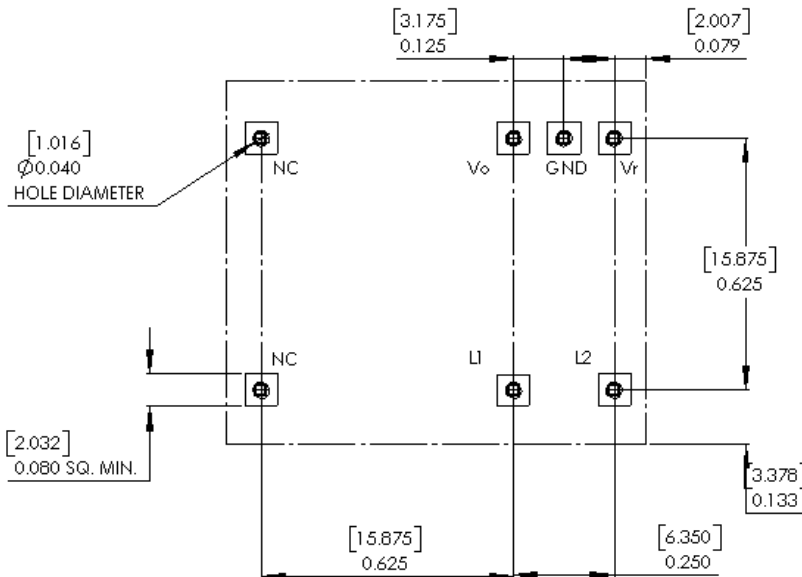

## Isolation, Bottom View

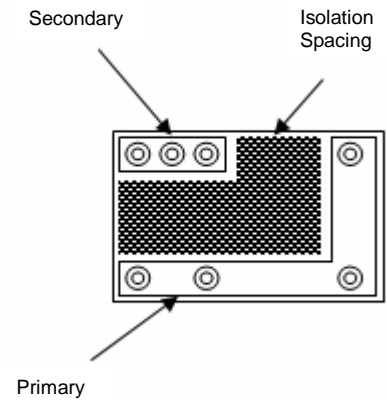

- NOTES**
1. Pins 0.025" [0.63 mm] square
  2. Pins extend 0.125" [3.17 mm] below stand-offs