

SX-SDMAC-Plus

802.11ac Wi-Fi / BT Combo SDIO Module

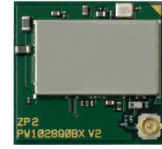

Smaller, Cheaper, and Higher Performance Wireless Module

Based on the QCA9377 SoC, SX-SDMAC-Plus is a dual-band IEEE802.11a/b/g/n/ac WLAN plus Bluetooth 4.2 BR/EDR/LE “Smart Ready” SDIO module. This new design is optimized for cost, size and performance that makes it a very compelling option for customers who want to take advantage of the higher 802.11ac performance at a lower cost and smaller overall footprint.

It is optimized for both size and cost by redesigning the PCB, removing the RF switch and the additional antenna connector available on our other SX-SDMAC SKU's. Also by using an Xtal crystal oscillator instead of TCXO, the SX-SDMAC-Plus offers higher Tx power which results in better Wi-Fi coverage and performance.

In addition to the hardware, there are many driver options available. We have reference drivers available for Linux, Android and Windows OS. For those who want to choose the open source route to get the benefits of having the latest kernel version supported by the open source community, ath10k driver is also available.

The SX-SDMAC is a FCC/IC/CE/MIC certified module. To expedite your product development process, Silex can provide both hardware and software engineering services including custom driver development, as well as turnkey product design and manufacturing.

Key Features:

- Optimized for size, cost and performance
- Based on the QCA9377-3 chipset
- 802.11 a/b/g/n/ac Wave 2 MU-MIMO
- Bluetooth 4.2 BR/EDR/LE Smart Ready
- Enhanced Tx Power
- SDIO 3.0 WLAN host interface
- Link Rate upto 433 Mbps
- Supports enterprise security, seamless roaming and CCX
- Fine tuned calibration per module
- FCC/IC/CE/MIC modular certification
- Extended temperature range
- Surface mount, and SDIO card form factor versions

Diagram:

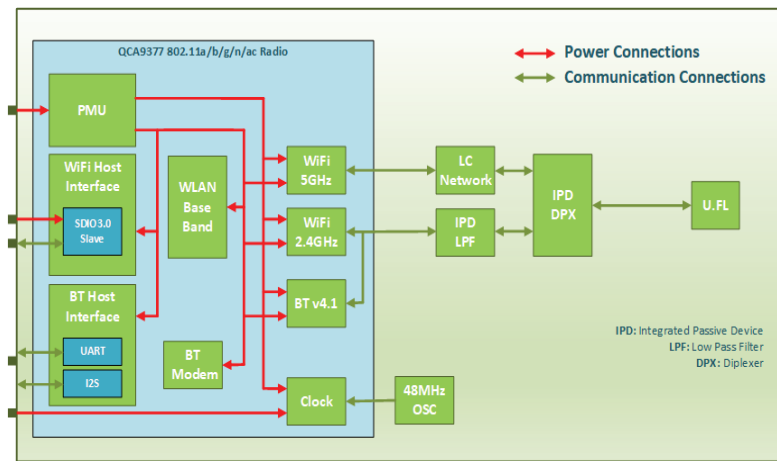

Specifications:

Product Name	SX-SDMAC-2832S+
Chipset	QCA9377-3
Host Interface	SDIO V 3.0 : WLAN High Speed UART: Bluetooth
Operating Voltage	3.30 VDC +/- 5%
Radio Specifications	802.11b/g/n: 2.412 - 2.472GHz 802.11a/n/ac: 5.180 - 5.825 GHz Bluetooth: 2.402 – 2.480 GHz
Baseband Specifications	CSMA/CA media access; DSSS, OFDM
Bluetooth Specifications	BT4.2 BR/EDR/LE “Smart Ready”
Operating Temperature	-20 - +85 °C
Dimensions	17.0 x 18.0 x 2.6 mm
Connector Type	SMT: Direct solder pad 44 pins
Antenna Configuration	1x1 mode (1T1R)
Modular Certifications	FCC/IC, CE, MIC

QCA9377 SKU's

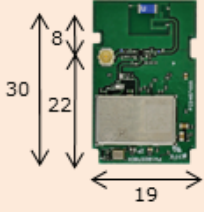
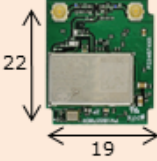
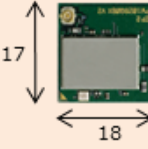
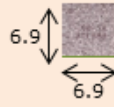
Name	SX-SDMAC-2830S	SX-SDMAC-2831S	SX-SDMAC-2832S+	SX-SDPAC-2830
Shape				
Operating Temperature	-40 ~ +85 ° C	-40 ~ +85 ° C	-20 ~ +85 ° C	-20 ~ +70 ° C
Antenna	Onboard + U.FLx1	U.FLx2	U.FLx1	Requires RF Design
Cost	\$\$\$	\$\$\$	\$\$	\$

Higher 802.11ac Throughput

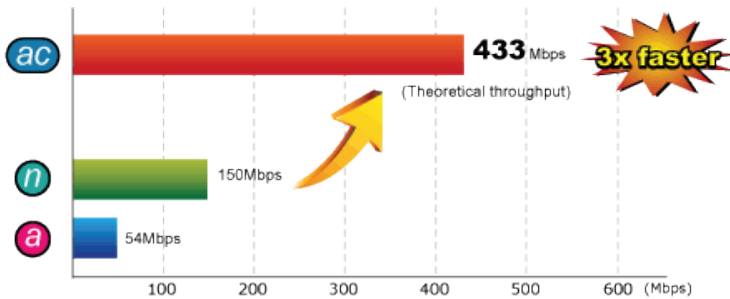

Driver Support

Wi-Fi Reference Drivers:

- Linux
- AP Mode and STA Mode.
- WPA2/WPA, TKIP, AES Encryption, IEEE 802.1X, EAP
- IEEE 802.11e (QoS)
- WPS2.0
- Wi-Fi Direct
- Android
- Windows
- WEC 7, WEC2013, Win10 /10 IoT

Ordering Information

- SX-SDMAC-2832S+: SMT, Bulk Package (1 U.FL Connectors)
- SX-SDMAC-2832S+SP: SMT, Sample Pack (1 U.FL Connectors)
- SX-SDCAC-2832S+SP: QCA9377 Evaluation Module (Includes antennas and cables)

Maximum Speed: Next Generation 802.11ac vs. 802.11n

silex technology is a registered trademark of silex technology, Inc. Other product or brand names may be registered trademarks or trademarks of their respective owners. Technical information and specifications are subject to change without notice. © 2017 silex technology, Inc. All rights reserved.

silex global sales & support locations