

# TFT-DISPLAY DATASHEET

AUO  
Model: G050VTN01.1

## BRIEF SPEC.:

Main Feature	Landscape Type White LED Backlight Sunlight Readable
Active Screen Area	108 x 64.8 [mm]
Diagonal   Format	5"   15:9
Resolution	800 x 480
Colors	16.7M (8-bit )
Backlight	LED, White
Brightness	1000 cd/m <sup>2</sup>
LED Life Time	40.000 [Typ]
Interface	TTL
Viewing Angle	-70~70(H), -50~70(V)
Touchscreen	No
Power Supply	3.3V [Typ.]
Module Outline	119.33 x 79.18x 8 [mm]
Operation Temperature	-20... +70 °C
Storage Temperature	-30... +80 °C
Surface Treatment	Antiglare Hard Coating

Preliminary Specifications

Final Specifications

<b>Module</b>	5.0 Inch Color TFT-LCD
<b>Model Name</b>	G050VTN01.1

Customer	Date
<b>Checked &amp; Approved by</b>  _____	

Note: This Specification is subject to change without notice.

<b>Approved by</b>  <u>Grace Hung</u>	<b>Date</b>  <u>2015/01/12</u>
<b>Prepared by</b>  <u>Christine Huang</u>	<b>Date</b>  <u>2015/01/12</u>

Audio-Video Business Unit /  
AU Optronics corporation

**Contents**

<b>1. Operating Precautions .....</b>	<b>4</b>
<b>2. General Description .....</b>	<b>5</b>
2.1 Display Characteristics .....	5
2.2 Optical Characteristics .....	6
<b>3. Functional Block Diagram .....</b>	<b>9</b>
<b>4. Absolute Maximum Ratings.....</b>	<b>10</b>
4.1 Absolute Ratings of TFT LCD Module.....	10
<b>5. Electrical Characteristics.....</b>	<b>11</b>
5.1 TFT LCD Module .....	11
5.2 Backlight Unit.....	13
<b>6. Signal Characteristic.....</b>	<b>14</b>
6.1 Pixel Format Image.....	14
6.2 Signal Description .....	15
6.3 Interface Timing .....	17
6.4 Power ON/OFF Sequence .....	19
<b>7. Reliability Test Criteria.....</b>	<b>20</b>
<b>8. Mechanical Characteristics .....</b>	<b>21</b>
8.1 LCM Outline Dimension .....	21
<b>9. Label and Packaging.....</b>	<b>22</b>
9.1 Shipping Label (on the rear side of TFT-LCD display) .....	22
9.2 Carton Package .....	22
<b>10 Safety.....</b>	<b>23</b>
10.1 Sharp Edge Requirements.....	23
10.2 Materials .....	23
10.3 Capacitors.....	23
10.4 National Test Lab Requirement.....	23



**Record of Revision**

Version Date	Page	Old description	New Description
<b>V 0.1</b> <b>2014/5/19</b>	All	First Edition	
<b>V 0.2</b> <b>2014/8/8</b>	5	LCD Typical power consumption: 0.25 typ. (Ref.)	LCD Typical power consumption: 0.23 typ.
	5	Backlight Power consumption:0.54 typ	Backlight Power consumption: 2.33 typ
	5	Weight:58 (Ref)	Weight:79 +/-5
	5	Physical Size: TBD	Physical Size: 119.33(W) X 79.18(H) X 8.0(T) (max)
	6	Optical Characteristics: Color Coordinates TBD	Update Color Coordinates
	6	Optical Characteristics White Luminance I <sub>F</sub> = 120mA	Optical Characteristics White Luminance I <sub>F</sub> = 108mA
	11	Power Specification	Update power specification
	13	Backlight Unit: Parameter for LED	Update Backlight Unit: Parameter for LED
	20	Reliability Test critical: Thermal Cycle	Reliability Test critical: Thermal Shock
<b>V 1.0</b> <b>2014/10/7</b>	5	Backlight Power consumption:2.33 typ	Backlight Power consumption: 2.42 typ
	5	LCD Typical Power consumption	LCD Typical Power consumption: 0.25 typ
	11	Original Power Specification	Update Power Specification
	13	Backlight Unit: Parameter for LED	Update Backlight Unit: Parameter for LED
	15	Recommended connector : FCI_62684_4011D0ALF	Recommended connector : FCI_62684_4011D0ALF or FH28-40S-0.5SH(05)
	21	module initial 2D-drawing	Update module 2D-drawing for new label
	22	Original Shipping label	Update new shipping label
<b>Ver 1.1</b> <b>2014/11/3</b>	22	Original shipping label	Update new shipping label: Adjust text location, No change for the bar code area
<b>Ver 1.2</b> <b>2014/12/02</b>	13	Original LED life:20,000 hrs	Updated LED life: 40, 000hrs
<b>Ver 1.3</b> <b>2015/1/12</b>	13	Original LED light bar Min Voltage: 21V	Updated LED light bar Min Voltage: 19.6V
	13	Original Min Power consumption: 2.268W	Updated Min Power consumption: 2.1168W

## 1. Operating Precautions

- 1) Since front polarizer is easily damaged, please be cautious not to scratch it.
- 2) Be sure to turn off power supply when inserting or disconnecting from input connector.
- 3) Wipe off water drop immediately. Long contact with water may cause discoloration or spots.
- 4) When the panel surface is soiled, wipe it with absorbent cotton or soft cloth.
- 5) Since the panel is made of glass, it may be broken or cracked if dropped or bumped on hard surface.
- 6) To avoid ESD (Electro Static Discharge) damage, be sure to ground yourself before handling TFT-LCD Module.
- 7) Do not open nor modify the module assembly.
- 8) Do not press the reflector sheet at the back of the module to any direction.
- 9) In case if a module has to be put back into the packing container slot after it was taken out from the container, do not press the center of the LED Reflector edge. Instead, press at the far ends of the LED Reflector edge softly. Otherwise the TFT Module may be damaged.
- 10) At the insertion or removal of the Signal Interface Connector, be sure not to rotate nor tilt the Interface Connector of the TFT Module.
- 11) After installation of the TFT Module into an enclosure (Notebook PC Bezel, for example), do not twist nor bend the TFT Module even momentarily. At designing the enclosure, it should be taken into consideration that no bending/twisting forces are applied to the TFT Module from outside. Otherwise the TFT Module may be damaged.
- 12) Small amount of materials having no flammability grade is used in the LCD module. The LCD module should be supplied by power complied with requirements of Limited Power Source (IEC60950 or UL1950), or be applied exemption.
- 13) Severe temperature condition may result in different luminance, response time.
- 14) Continuous operating TFT-LCD Module under high temperature environment may accelerate LED light bar exhaustion and reduce luminance dramatically.
- 15) The data on this specification sheet is applicable when LCD module is placed in landscape position.
- 16) Continuous displaying fixed pattern may induce image sticking. It is recommended to use screen saver or shuffle content periodically if fixed pattern is displayed on the screen.

## 2. General Description

This specification applies to the 5.0 inch color TFT LCD module G050VTN01.1.

G050VTN01.1 is built in timing controller and TTL interface. The screen format is intended to support the WVGA (800(H) x 480(V)) screen and 16.2M (RGB 8-bits) G050VTN01.1 is a RoHS product.

### 2.1 Display Characteristics

The following items are characteristics summary on the table under 25 °C condition:

Items	Unit	Specifications
Screen Diagonal	[inch]	5.0
Active Area	[mm]	108.0(W) x 64.8(H)
Pixels H x V		800 x 3(RGB) x 480
Pixel Pitch	[mm]	0.135(W) x 0.135(H)
Pixel Arrangement		R.G.B. Vertical Stripe
Display Mode		TN, Normally White
Nominal Input Voltage VDD	[Volt]	3.3 typ.
LCD Typical Power Consumption	[Watt]	0.25 typ.
Back Light Power Consumption	[Watt]	2.42 typ.
Weight	[Grams]	79 +/- 5
Physical Size	[mm]	119.33(W) X 79.18(H) X 8.0(T) (max)
Electrical Interface		40 pins RGB 8-bits
Surface Treatment		Anti-Glare type, 3H
Support Color		16.2M(8-bit with dithering)
Temperature Range Operating Storage (Non-Operating)	[°C] [°C]	-20 to +70 -30 to +80
RoHS Compliance		RoHS Compliance
Viewing Direction		12 o'clock
Gray Scale Inversion Direction		6" o'clock

## 2.2 Optical Characteristics

The optical characteristics are measured under stable conditions at 25 (Room Temperature):

Item	Unit	Conditions	Min.	Typ.	Max.	Note
White Luminance	[cd/m <sup>2</sup> ]	I <sub>F</sub> = 108mA (center point)	800	1000	-	1
Uniformity	%	9 Points	75%	80%		1.2.3
Contrast Ratio			500	600	-	4
Response Time	[msec]	Rising + Falling	-	20	30	
Viewing Angle	[degree]	Horizontal (Right) CR 10 (Left)	60	70	-	6
	[degree]		60	70	-	
	[degree]	Vertical (Upper) CR 10 (Lower)	40	50	-	
	[degree]		60	70	-	
Color / Chromaticity Coordinates (CIE 1931)		Red x	0.558	0.608	0.658	1 & 7
		Red y	0.279	0.329	0.379	
		Green x	0.293	0.343	0.393	
		Green y	0.516	0.566	0.616	
		Blue x	0.111	0.161	0.211	
		Blue y	0.044	0.094	0.144	
		White x	0.26	0.31	0.36	
		White y	0.28	0.33	0.38	
Color Gamut	%		-	50	-	1

Note 7: RGBW Color Coordinates are based on the simulation result

Note 1: Measurement method

Equipment: Pattern Generator, Power Supply, Digital Voltmeter, Luminance meter (BM-5A or equivalent)

Scanning Direction : Normal Scan

Aperture 1° with 50cm viewing distance

Test Point Center,

Environment < 1 lux

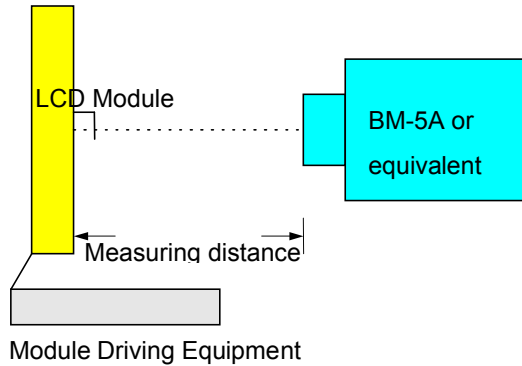

Note 2: Definition of 9 points position (Display active area: 108.0(H) x 64.8(V)) mm

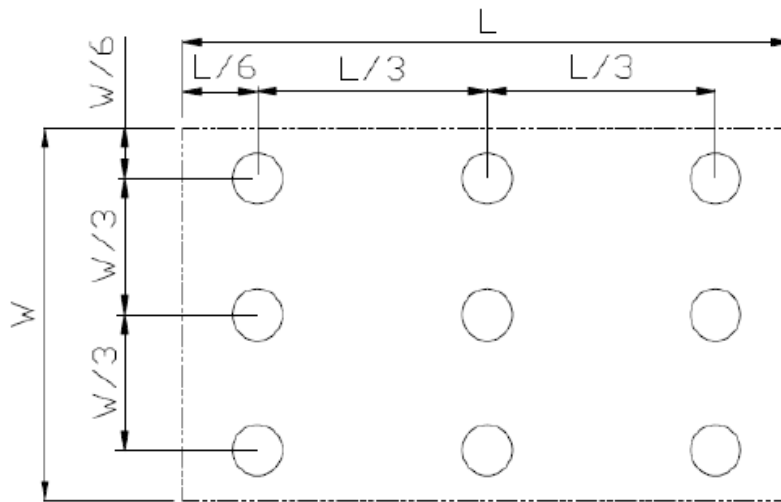

Note 3:

The luminance uniformity of 9 points is defined by dividing the maximum luminance value by the minimum luminance value at full white condition.

$$\text{Uniformity (\%)} = \frac{\text{Minimum Brightness of nine points}}{\text{Maximum Brightness of nine points}}$$

Note 4 : Definition of contrast ratio (CR):

$$\text{Contrast ratio (CR)} = \frac{\text{Brightness on the "White" state}}{\text{Brightness on the "Black" state}}$$



Note 5: Definition of response time:

The output signals of photo detector are measured when the input signals are changed from “Black” to “White” (falling time) and from “White” to “Black” (rising time), respectively. The response time interval is between 10% and 90% of amplitudes. Please refer to the figure as below.

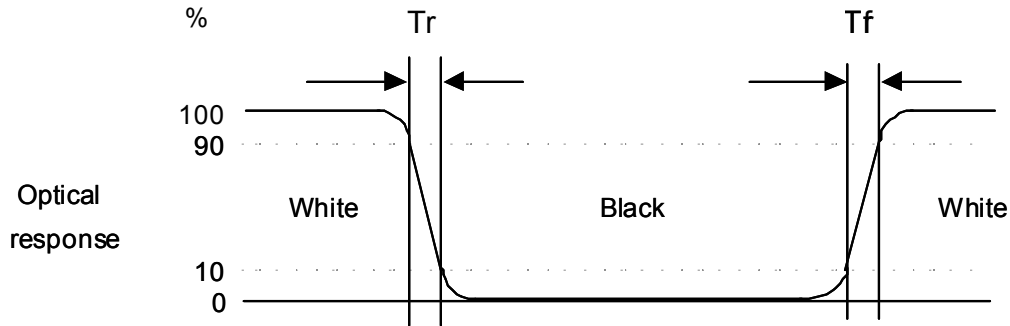

Note 6: Definition of viewing angle

Viewing angle is the measurement of contrast ratio 10, at the screen center, over a 180° horizontal and 180° vertical range (off-normal viewing angles). The 180° viewing angle range is broken down as below: 90° ( $\theta$ ) horizontal left and right, and 90° ( $\Phi$ ) vertical high (up) and low (down). The measurement direction is typically perpendicular to the display surface with the screen rotated to its center to develop the desired measurement viewing angle.

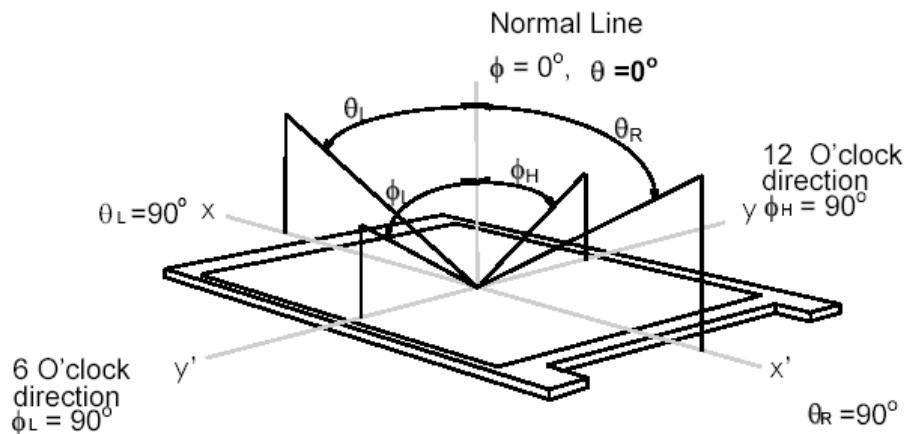

### 3. Functional Block Diagram

The following diagram shows the functional block of the 5.0 inch color TFT/LCD module:

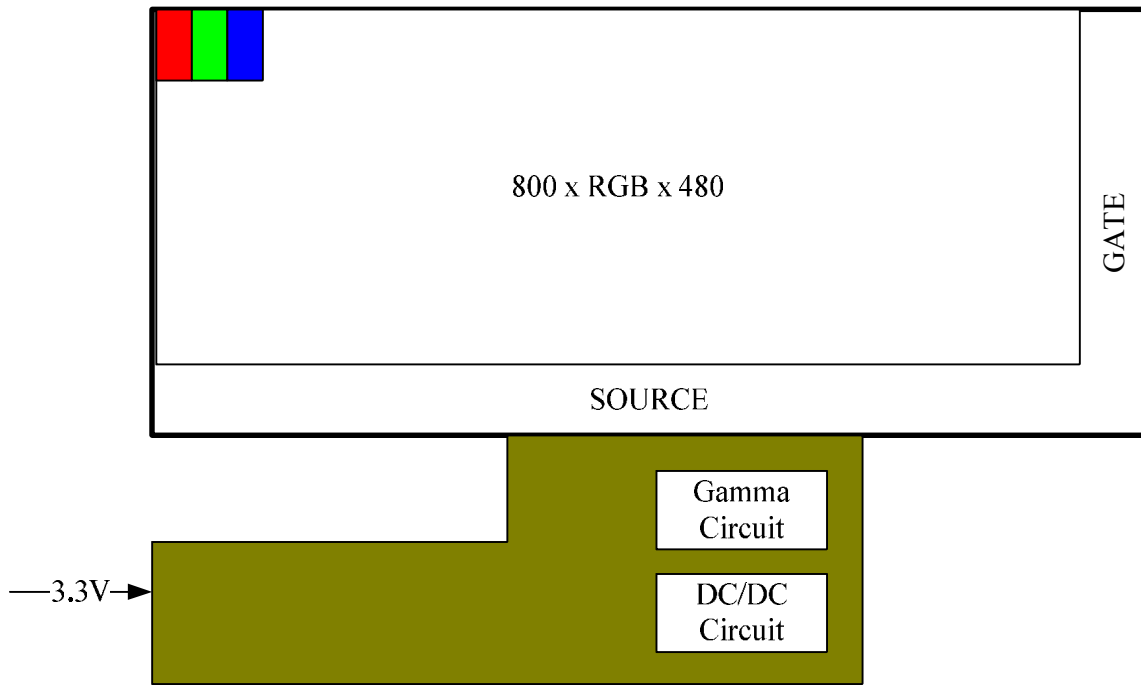

## 4. Absolute Maximum Ratings

### 4.1 Absolute Ratings of TFT LCD Module

Item	Symbol	Min	Max	Unit	Conditions
LCD Drive Voltage	VDD	-0.3	+5	[Volt]	
Input signal Voltage	Vin	-0.3	+5	[Volt]	

## 5. Electrical Characteristics

### 5.1 TFT LCD Module

#### 5.1.1 Power Specification

Symbol	Parameter	Min	Typ	Max	Units	Remark
VDD	Logic/LCD Drive Voltage	3.0	3.3	3.6	[Volt]	±10%
I <sub>VDD</sub>	VDD Current	-	75	90	[mA]	All Black Pattern (VDD=3.3V, at 60Hz)
P <sub>VDD</sub>	VDD Power	-	0.25	0.3	[Watt]	All Black Pattern (VDD=3.3V, at 60Hz)
I <sub>rush</sub>	LCD Inrush Current	-	-	1.5	[A]	Note 1

Note 1: Measurement condition:

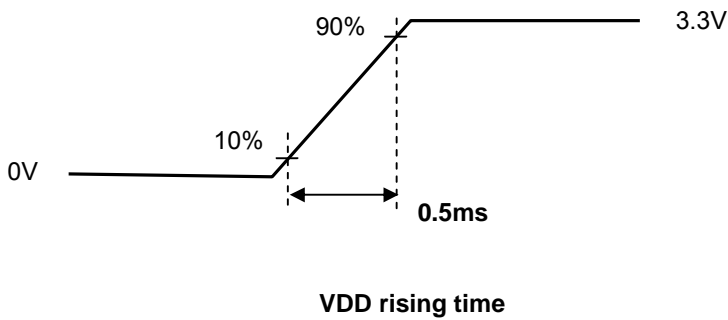

### 5.1.2 Signal Electrical Characteristics

Input signals shall be low or Hi-Z state when VDD is off.

Parameter		Symbol	Min.	Typ.	Max.	Unit	Remarks
Logic Input Voltage for Display Signals	High	VIH	0.7VDD	-	VDD	Volt	
	Low	VIL	0	-	0.3VDD	Volt	

## 5.2 Backlight Unit

### 5.2.1 Parameter guideline for LED

Parameter	Symbol	Min.	Typ.	Max.	Unit	Remark
LED light bar Voltage	$V_L$	19.6	22.4	25.2	V	
Current of Each LED	$I_{LED}$		54		mA	
Power Consumption	$P_{BL}$	2.1168	2.4192	2.7216	W	Note 1
LED Life Time	$L_L$	(40,000)	--	--	Hr	Note 2

Note 1: The LED driving condition is defined for LED module (14 LED). The voltage range will be up to 22.4V based on suggested driving current set as 108mA.

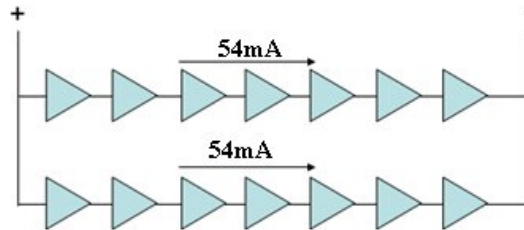

Note 2: Define "LED Lifetime": estimated brightness is decreased to 50% of the initial value. LED Lifetime is restricted under normal condition, ambient temperature = 25 .

## 6. Signal Characteristic

### 6.1 Pixel Format Image

Following figure shows the relationship between input signal and LCD pixel format.

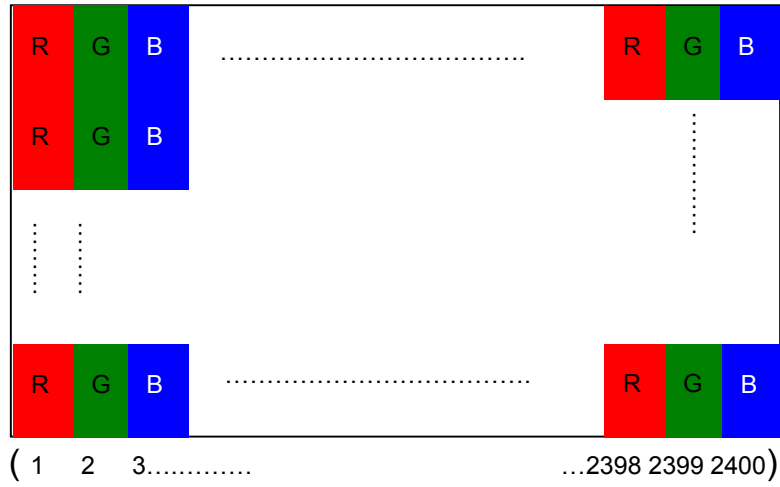

## 6.2 Signal Description

Recommended connector : FCI\_62684\_4011D0ALF or FH28-40S-0.5SH(05)

The connector pin definition is as below.

Pin No.	Symbol	I/O	Description
1	VLED-	P	Black light for cathode
2	VLED+	P	Back light for anode
3	VDD	P	Power supply
4	GND	G	Ground
5	Display_EN	I	Stand by mode. (Internal pull low) STBYB="1": Normally operation. STBYB="0": Standby mode. Timing controller, source driver will turn off, all output are High-Z
6	R0	I	Red Data input (LSB)
7	R1	I	Red Data input
8	R2	I	Red Data input
9	R3	I	Red Data input
10	GND	G	Ground
11	R4	I	Red Data input
12	R5	I	Red Data input
13	R6	I	Red Data input
14	R7	I	Red Data input (MSB)
15	GND	G	Ground
16	G0	I	Green Data input (LSB)
17	G1	I	Green Data input
18	G2	I	Green Data input
19	G3	I	Green Data input
20	GND	G	Ground
21	G4	I	Green Data input
22	G5	I	Green Data input
23	G6	I	Green Data input
24	G7	I	Green Data input (MSB)
25	GND	G	Ground
26	B0	I	Blue Data input (LSB)
27	B1	I	Blue Data input
28	B2	I	Blue Data input
29	B3	I	Blue Data input
30	GND	G	Ground



31	B4	I	Blue Data input
32	B5	I	Blue Data input
33	B6	I	Blue Data input
34	B7	I	Blue Data input (MSB)
35	GND	G	Ground
36	DCLK	I	Clock for input data. Data latched at falling edge of this signal.
37	GND	G	Ground
38	DE	I	Data input enable. Active high to enable the data input bus under "DE Mode".
39	HSYNC	I	Horizontal sync input (Only use DE mode, please pull low)
40	VSYNC	I	Vertical sync input (Only use DE mode, please pull low)

Note1 : I/O Definition, I = Input, P = Power, G = Ground.

Note2 : "Low" stands for 0V. "High" stands for 3.3V.

## 6.3 Interface Timing

### 6.3.1 Signal AC Characteristics

Parameter	Symbol	Min.	Typ.	Max.	Unit	Remark
DCLK duty cycle	$D_{cw}$	40	50	60	%	$t_{cw} / t_{DCLK} \times 100\%$
Data Setup Time	$t_{dst}$	12	--	--	ns	
Data Hold Time	$t_{dhd}$	12	--	--	ns	
DE Setup Time	$t_{dest}$	12	--	--	ns	
DE Hold Time	$t_{dehd}$	12	--	--	ns	

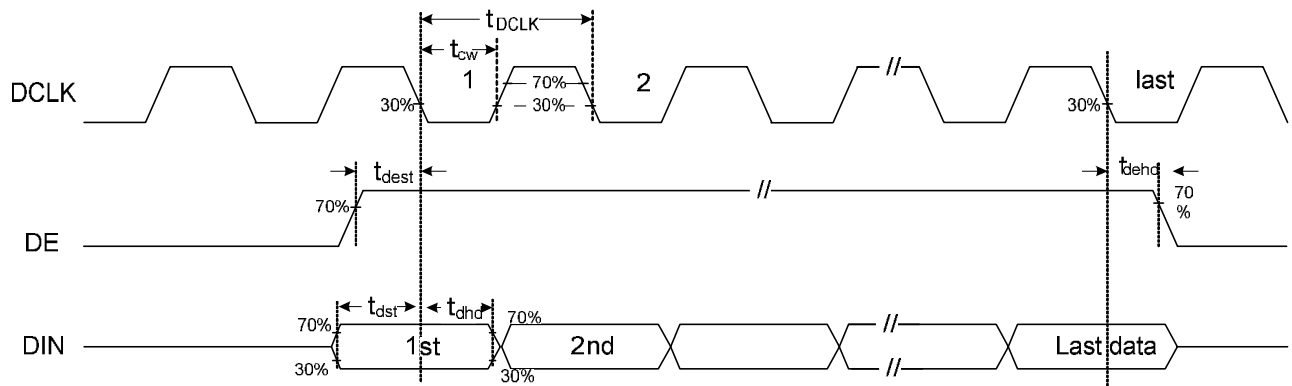

### 6.3.2 Input Timing Characteristics

#### DE mode

Parameter		Symbol	Min.	Typ.	Max.	Unit.	Remark
DCLK	Frequency	$1/t_{DCLK}$	25	30	36	MHz	
Frame Rate	Frequency		55	60	65	Hz	
1 Frame Scanning Time	Cycle	$t_v$	484	525	735	$t_H$	
	Display Period	$t_{vd}$	480			$t_H$	
	Blanking	$t_{vbl}$	4	45	255	$t_H$	
1 Line Scanning Time	Cycle	$t_H$	885	928	1312	$t_{DCLK}$	
	Display Period	$t_{hd}$	800			$t_{DCLK}$	
	Blanking	$t_{hbl}$	85	128	512	$t_{DCLK}$	

#### Vertical timing (DE mode):

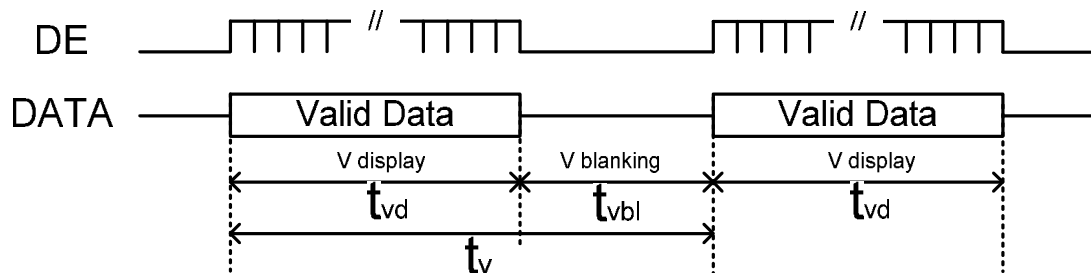

#### Horizontal timing (DE mode):

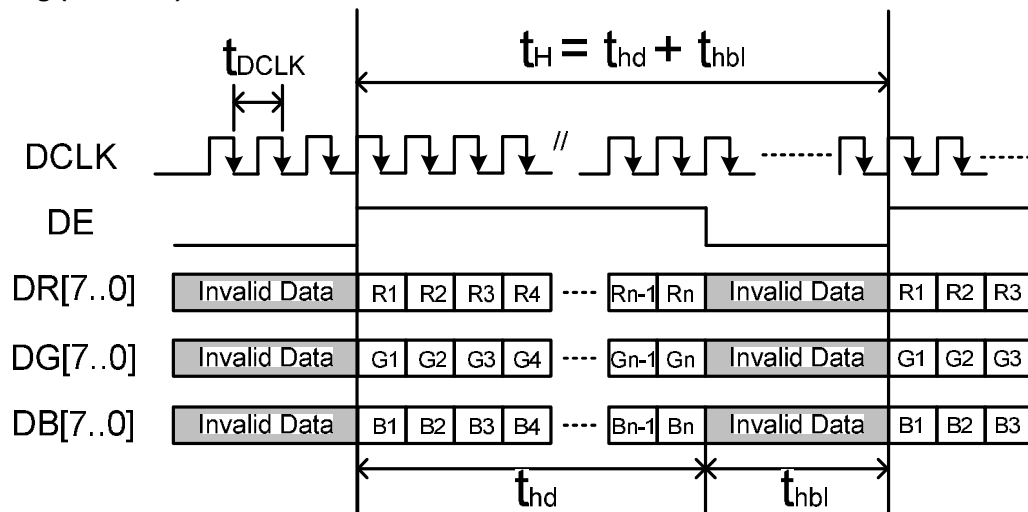

## 6.4 Power ON/OFF Sequence

VDD power and backlight on/off sequence is as below. Interface signals are also shown in the chart. Signals from any system shall be Hi-Z state or low level when VDD is off.

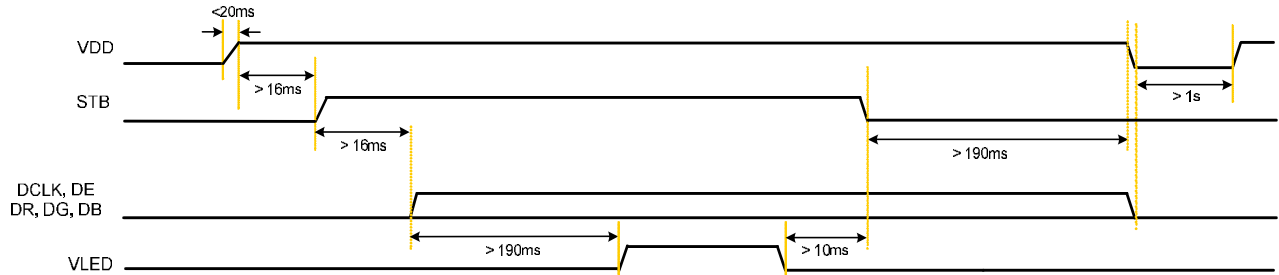

The above on/off sequence should be applied to avoid abnormal function in the display. Please make sure to turn off the power when you plug the cable into the input connector or pull the cable out of the connector.

## 7. Reliability Test Criteria

Items	Required Condition	Note
Temperature Humidity Bias	60 /90%,240 hours, Power On	Note 1
High Temperature Operation	70 ,240 hours	
Low Temperature Operation	-20 ,240 hours	
Hot Storage	80 ,240 hours	
Cold Storage	-30 ,240 hours	
Thermal Shock	-30 (30mins)<- -> + 80 (30 mins) Total 50 Cycles	
Shock Test (Non-Operating)	60G,6ms, 3 times for each direction	
Vibration Test (Non-Operating)	Frequency Range : 10 ~ 55 Hz Stroke : 1.5mm Sweep : 10 Hz ~ 55 Hz ~ 10 Hz 2 hours for each direction of X, Y, Z(6 hours of total)	
Vibration Test (Packaging Box)	Acceleration :2.0G Frequency Range : 10 ~ 100 Hz 2 hours for each direction of X, Y, Z.(6 hours of total)	
On/off test	On/10 sec, Off/10 sec, 30,000 cycles	
Drop Test	Height: 750mm Drop test must be done 6 times Once corner each time One flat sides each time	Note 2
ESD	Contact Discharge: ± 4KV, 150pF(330Ω ) Air Discharge: ± 8KV, 150pF(330Ω ) 6 times at each test point	

Note1: All of cosmetic specification is judged before the reliability stress. After AUO reliability test, the function defect is not allowed. Cosmetic defects and deficiencies are excluded from the inspection.

Note 2: According to EN61000-4-2, ESD class B: Some performance degradation allowed. No data lost  
Self-recoverable. No hardware failures.

## 8. Mechanical Characteristics

### 8.1 LCM Outline Dimension

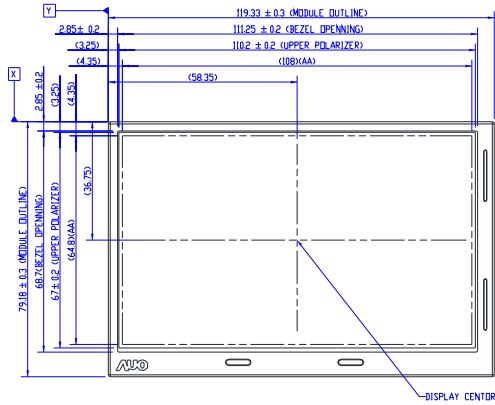

Note:  
 1. Resolution 600\*480  
 2. General tolerance is ±0.3  
 3. The bending radius of FPC should be large than 6mm.  
 4. The shape, dimension, location of conductive tape will be adjust after design fixed.

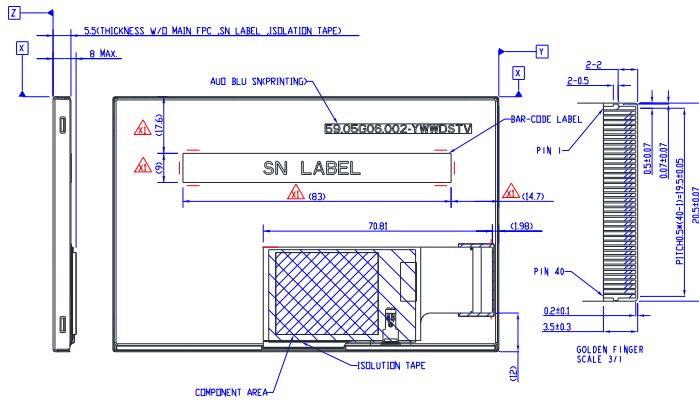

## 9. Label and Packaging

### 9.1 Shipping Label (on the rear side of TFT-LCD display)



### 9.2 Carton Package

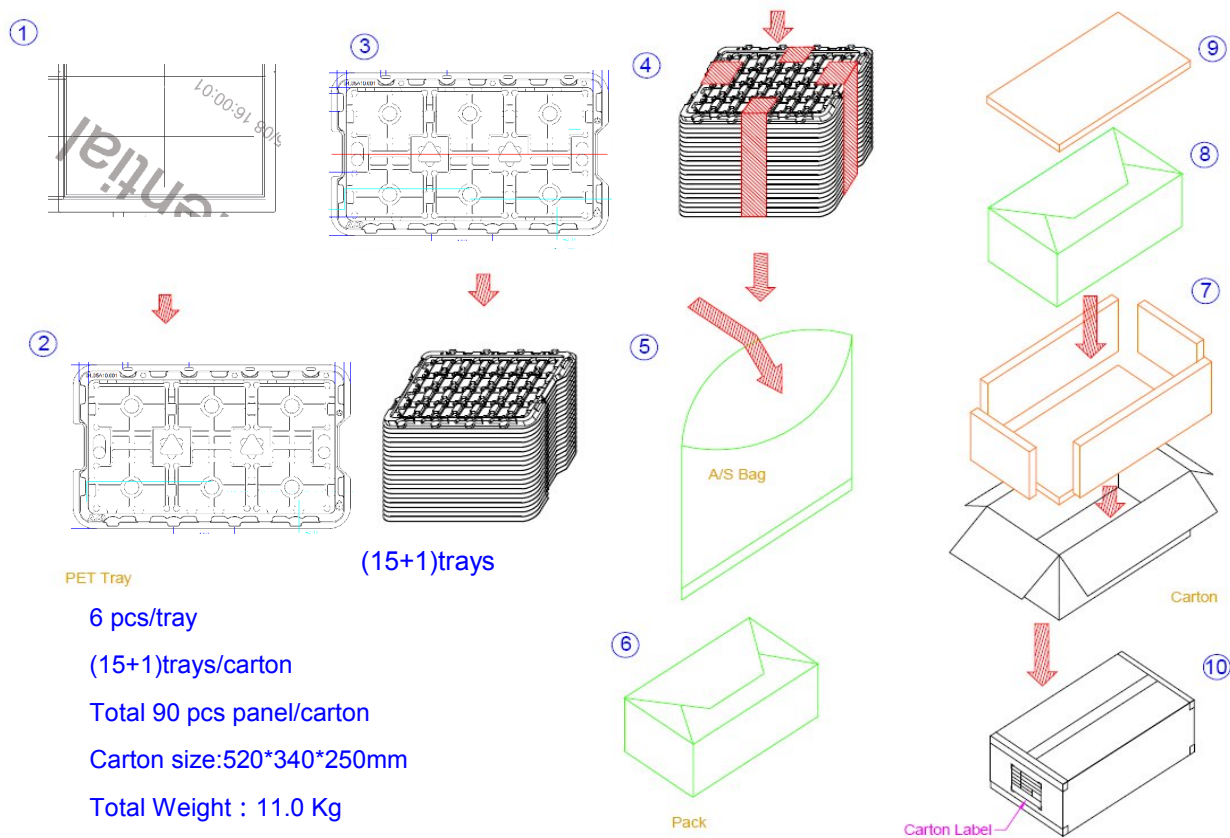

## 10 Safety

### 10.1 Sharp Edge Requirements

There will be no sharp edges or corners on the display assembly that could cause injury.

### 10.2 Materials

#### 10.2.1 Toxicity

There will be no carcinogenic materials used anywhere in the display module. If toxic materials are used, they will be reviewed and approved by the responsible AUO toxicologist.

#### 10.2.2 Flammability

All components including electrical components that do not meet the flammability grade UL94-V1 in the module will complete the flammability rating exception approval process.

The pRxINted circuit board will be made from material rated 94-V1 or better. The actual UL flammability rating will be pRxINted on the pRxINted circuit board.

### 10.3 Capacitors

If any polarized capacitors are used in the display assembly, provisions will be made to keep them from being inserted backwards.

### 10.4 National Test Lab Requirement

The display module will satisfy all requirements for compliance to:

**UL 1950, First Edition**

U.S.A. Information Technology Equipment