

# TFT-DISPLAY DATASHEET

AUO  
Model: G156XTT01.1

## BRIEF SPEC.:

Main Feature	Landscape Type White LED Backlight With Touchscreen
Active Screen Area	344.23 x 193.53 (mm)
Diagonal   Format	15.6"   16:9
Resolution	1366 X 768
Colors	262k16.7M (6 Bit)
Backlight	LED
Brightness	350 cd/m <sup>2</sup>
LED Life Time	50K (h)
Interface	LVDS
Viewing Angle	85/85 L/R 80/80
Touchscreen	Yes
Power Supply	5.0 V (Typ.)
Module Outline	363.8 x 215.9 x 12.5 (mm)
Operation Temperature	0... +60 °C
Storage Temperature	-20... +60 °C
Surface Treatment	Anti-Glare, Hardness 3H

( ) Preliminary Specifications  
 (V) Final Specifications

<b>Module</b>	15.6 Inch Color TFT-LCD
<b>Model Name</b>	G156XTT01.1
<b>Note</b> (  )	G/G P-cap touch TTL module

Customer	Date
iEi	
<b>Checked &amp; Approved by</b>	
Note: This Specification is subject to change without notice.	

Approved by	Date
Sean Lin	2015/10/15
<b>Prepared by</b>	
Robert Hsieh	2015/10/15
Audio-Video Business Unit / AU Optonics corporation	

## Contents

<b>1. Operating Precautions .....</b>	<b>4</b>
<b>2. General Description .....</b>	<b>5</b>
2.1 Display Characteristics .....	5
2.2 General Touch Characteristics .....	6
2.3 Optical Characteristics .....	7
<b>3. Functional Block Diagram .....</b>	<b>12</b>
<b>4. Absolute Maximum Ratings.....</b>	<b>13</b>
4.1 Absolute Ratings of TFT LCD Module.....	13
4.2 Absolute Ratings of Touch Sensor .....	13
4.3 Absolute Ratings of Environment.....	13
<b>5. Electrical Characteristics.....</b>	<b>15</b>
5.1 TFT LCD Module .....	15
5.2 Backlight Unit.....	17
5.3 Touch Sensor .....	17
<b>6. Signal Characteristic.....</b>	<b>19</b>
6.1 Pixel Format Image .....	19
6.2 The input data format.....	19
6.3 Signal Description .....	20
6.4 Timing Characteristics.....	22
6.5 I Input Timing Diagram.....	23
6.6 Power ON/OFF Sequence .....	24
<b>7. Connector &amp; Pin Assignment .....</b>	<b>26</b>
7.1 TFT-LCD Signal: LVDS Interface .....	26
7.2 T Backlight Unit.....	27
7.2.1 T Backlight Unit.....	27
7.3 Touch Signal : USB Interface .....	27
7.4 Touch Connector Illustration .....	28
<b>8. Reliability Test Criteria.....</b>	<b>29</b>
<b>9. Mechanical Characteristics .....</b>	<b>30</b>
9.1 Total solution Outline Dimension (Front View) .....	30
9.2 Total solution Outline Dimension (Rear View).....	31
<b>10. Label and Packaging.....</b>	<b>32</b>
10.1 Shipping Label (on the rear side of TFT-LCD display) .....	32
10.2 Carton Package .....	33
10.3 Palletizing.....	34



**Record of Revision**

<b>Version and Date</b>	<b>Page</b>	<b>Old description</b>	<b>New Description</b>
0.0 2015/9/22	All	First Preliminary Edition	
1.0 2015/10/13	All	First Formal Edition	
1.1 2015/10/15	30,31	Power button, FPCA	Power button black circle, FPCA with Kapton at front side & back side, add vendor 2D code on FPCA front side

## 1. Operating Precautions

- 1) Since front polarizer is easily damaged, please be cautious and not to scratch it.
- 2) Be sure to turn off power supply when inserting or disconnecting from input connector.
- 3) Wipe off water drop immediately. Long contact with water may cause discoloration or spots.
- 4) When the panel surface is soiled, wipe it with absorbent cotton or soft cloth.
- 5) Since the panel is made of glass, it may be broken or cracked if dropped or bumped on hard surface.
- 6) Since CMOS LSI is used in this module, take care of static electricity and insure human earth when handling.
- 7) Do not open nor modify the module assembly.
- 8) Do not press the reflector sheet at the back of the module to any direction.
- 9) In case if a module has to be put back into the packing container slot after it was taken out from the container, do not press the center of the LED Reflector edge. Instead, press at the far ends of the LED Reflector edge softly. Otherwise the TFT Module may be damaged.
- 10) At the insertion or removal of the Signal Interface Connector, be sure not to rotate nor tilt the Interface Connector of the TFT Module.
- 11) TFT-LCD Module is not allowed to be twisted & bent even force is added on module in a very short time. Please design your display product well to avoid external force applying to module by end-user directly.
- 12) Small amount of materials without flammability grade are used in the TFT-LCD module. The TFT-LCD module should be supplied by power complied with requirements of Limited Power Source (IEC60950-1 or UL60950-1), or be applied exemption.
- 13) Severe temperature condition may result in different luminance, response time.
- 14) Continuous operating TFT-LCD Module under high temperature environment may accelerate LED light bar exhaustion and reduce luminance dramatically.
- 15) The data on this specification sheet is applicable when TFT-LCD module is placed in landscape position.
- 16) Continuous displaying fixed pattern may induce image sticking. It's recommended to use screen saver or moving content periodically if fixed pattern is displayed on the screen.

## 2. General Description

This specification applies to the 15.6 inch-wide Color a-Si TFT-LCD Module G156XW01. The display supports the HD - 1366(H) x 768(V) screen format and 16.2M colors (RGB 6-bits + 2-FRC data). All input signals are LVDS interface and this module contains with an LED driver for backlight.

### 2.1 Display Characteristics

The following items are characteristics summary on the table under 25 °C condition:

Items	Unit	Specifications
Screen Diagonal	[inch]	15.6
Active Area	[mm]	344.232 (H) x 193.536 (V)
Pixels H x V		1366(x3) x 768
Pixel Pitch	[mm]	252 (per one triad) x252
Pixel Arrangement		R.G.B. Vertical Stripe
Display Mode		TN, Normally White
Nominal Input Voltage VDD	[Volt]	+5.0 V
LCD Power Consumption	[Watt]	2.15W (Typ.), 2.6W (Max.) (all black pattern)
LED Power Consumption	[Watt]	6W (Typ.), 7.2 W (Max.) (all black pattern)
Weight	[Grams]	1350 (Typ.), 1485 (Max.)
Physical Size	[mm]	363.8(W) X 215.9(H) X 9.3 (D) Typ.
Electrical Interface		One channel LVDS
Surface Treatment		Anti-Glare, 3H
Support Color		16.2M
Temperature Range Operating Storage (Non-Operating)	[°C] [°C]	0 to +60(+60°C as panel surface temperature) -20 to +60
RoHS Compliance		RoHS Compliance
Light Bar Unit		LED, Replaceable

## 2.2 General Touch Characteristics

Item		Unit	Specifications
Cover Lens	O.D.	[mm]	382.2x 245.8
	Thickness	[mm]	1.1
C/L Visual Area		[mm]	346 x 195.3
Sensor Glass	O.D.	[mm]	357.8 x 205.3
	Thickness	[mm]	0.7
TP Active Area		[mm]	346.2 x 195.5
Total Weight		g	630 (max.)
Substrate Material			SDL CS Glass
Chemical Strength		Mpa	400
Surface Hardness			7H
Interface			USB 1.1 full speed
Touch Resolution			Same with display resolution
Single / Multi-touch Accuracy		[mm]	Center: 1 Edge 1.5
Linearity		[mm]	Center +/-1 Edge: +/-1.5
The smallest distance between 2 points		[mm]	13
Channel (X * Y)			72 * 41
Report Rate (points /sec)		[Hz]	>100
Power Consumption		[mW]	454 (Max)
Operating System			Support windows 7, Win8 ,Linux & Android.

Note1. Driver is required in Win7 & WinXP & Linux & Android

## 2.3 Optical Characteristics

The optical characteristics are measured under stable conditions at 25 °C:

Item	Unit	Conditions	Min.	Typ.	Max.	Note
Viewing Angle	[degree]	Horizontal (Right)	75	85	-	1,2
		CR = 10 (Left)	75	85	-	
		Vertical (Up)	70	80	-	
		CR = 10 (Down)	70	80	-	
Contrast ratio		Normal Direction	350	500	-	3
Response Time	[msec]	Raising Time (T <sub>rR</sub> )	-	6	9	4
		Falling Time (T <sub>rF</sub> )	-	2	4	
		Raising + Falling	-	8	13	
Color Coordinates (CIE) White		Red x	0.575	0.625	0.675)	5
		Red y	0.293	0.343	0.393	
		Green x	0.276	0.326	0.376	
		Green y	0.567	0.617	0.667	6 7
		Blue x	0.104	0.154	0.204	
		Blue y	0.019	0.069	0.119	
		White x	0.263	0.313	0.363	
		White y	0.279	0.329	0.379	
Central Luminance	[cd/m <sup>2</sup> ]		280	350	-	
Luminance Uniformity	[%]		70	75	-	

### Note 1: Measurement method

The LCD module should be stabilized at given temperature for 30 minutes to avoid abrupt temperature change during measuring (at surface 35 °C). In order to stabilize the luminance, the measurement should be executed after lighting Backlight for 30 minutes in a stable, windless and dark room.



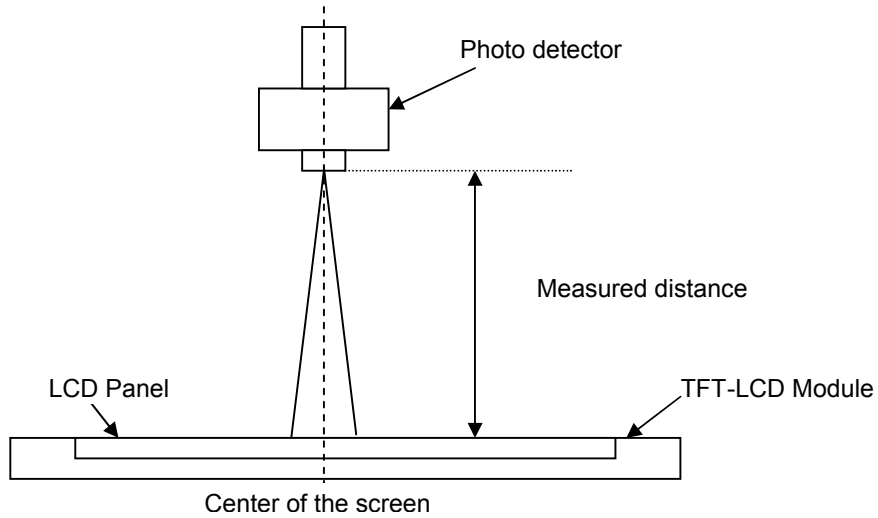

**Note 2: Definition of viewing angle** measured by ELDIM (EZContrast 88)

Viewing angle is the measurement of contrast ratio 10 and 5, at the screen center, over a 180° horizontal and 180° vertical range (off-normal viewing angles). The 180° viewing angle range is broken down as follows; 90° ( $\theta$ ) horizontal left and right and 90° ( $\phi$ ) vertical, high (up) and low (down). The measurement direction is typically perpendicular to the display surface with the screen rotated about its center to develop the desired measurement viewing angle.

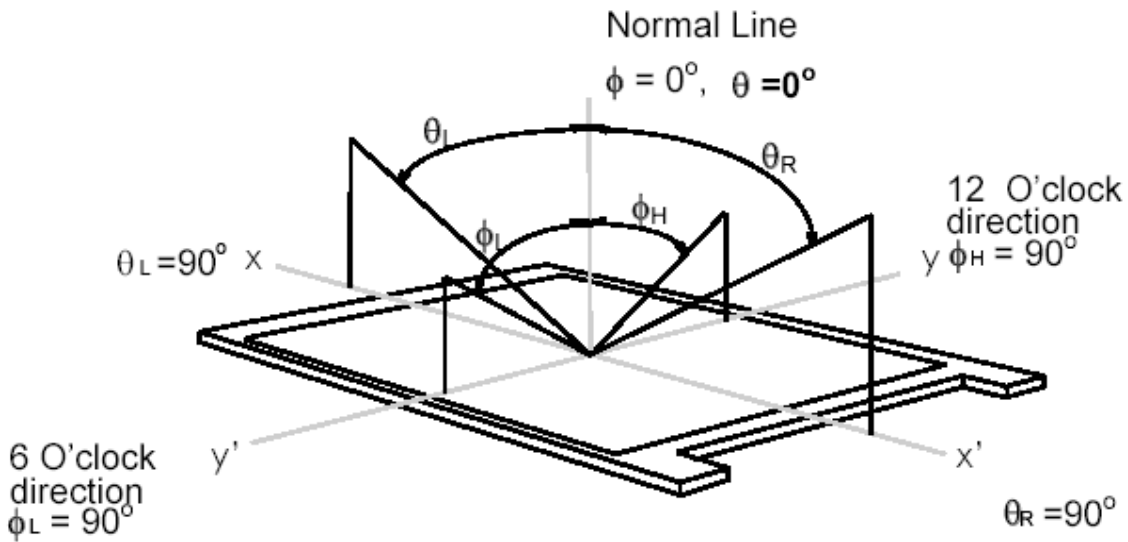

**Note 3: Contrast ratio** is measured by TOPCON SR-3

**Note 4: Definition of Response time** measured by Westar TRD-100A

The output signals of photo detector are measured when the input signals are changed from “Full Black” to “Full White” (rising time,  $Tr_R$ ), and from “Full White” to “Full Black” (falling time,  $Tf_F$ ), respectively. The response time is interval between the 10% and 90% (1 frame at 60 Hz) of amplitudes.

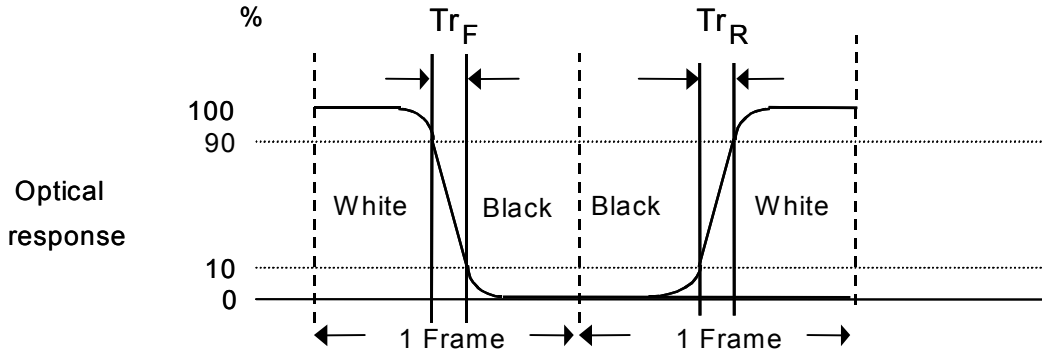

$Tr_R + Tf_F = 8 \text{ msec (typ.)}$ .

**Note 5: Color chromaticity and coordinates (CIE) is measured by TOPCON SR-3**

**Note 6: Central luminance is measured by TOPCON SR-3**

**Note 7: Luminance uniformity of these 9 points is defined as below and measured by TOPCON SR-3**

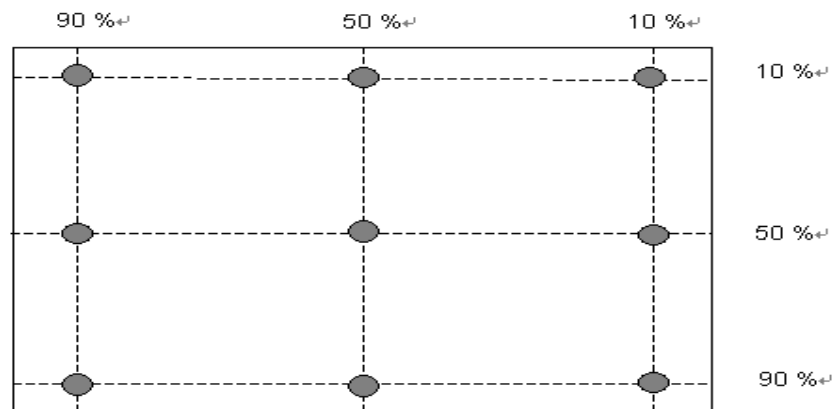

$$\text{Uniformity} = \frac{\text{Minimum Luminance in 9 points (1 - 9)}}{\text{Maximum Luminance in 9 Points (1 - 9)}}$$

Note 2: Definition of 9 points position (Display active area : 344.232(H) x 193.536(V))

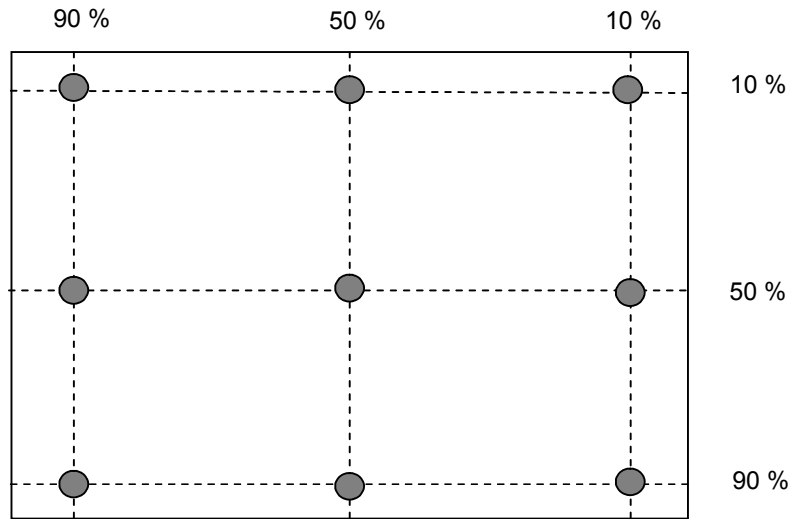

Note 3: The luminance uniformity of 9 points is defined by dividing the minimum luminance values by the maximum test point luminance

$$w_9 = \frac{\text{Minimum Brightness of nine points}}{\text{Maximum Brightness of nine points}}$$

Note 4 : Definition of contrast ratio (CR):

$$\text{Contrast ratio (CR)} = \frac{\text{Brightness on the "White" state}}{\text{Brightness on the "Black" state}}$$

Note 5 : Definition of cross talk (CT)

$$CT = |YB - YA| / YA \times 100 (\%)$$

Where

YA = Luminance of measured location without gray level 0 pattern (cd/m<sup>2</sup>)

YB = Luminance of measured location with gray level 0 pattern (cd/m<sup>2</sup>)

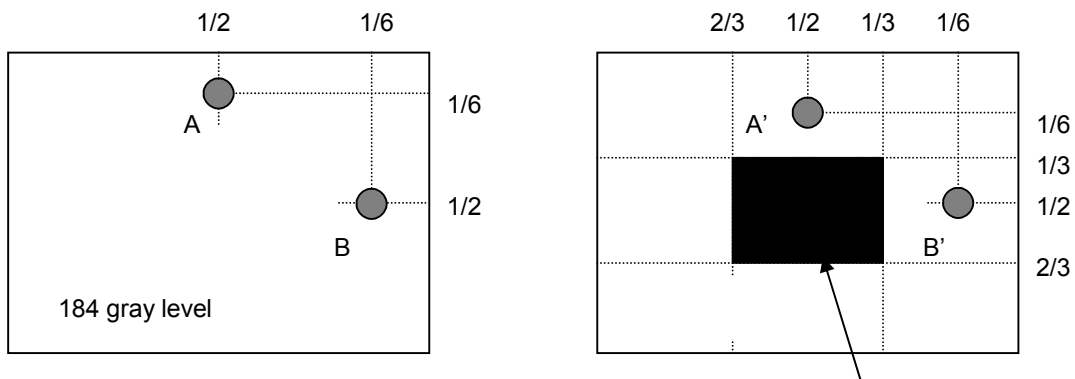

Note 6: Definition of response time:

The output signals of photo detector are measured when the input signals are changed from “White” to “Black” (falling time) and from “Black” to “White” (rising time), respectively. The response time interval is between 10% and 90% of amplitudes. Please refer to the figure as below.

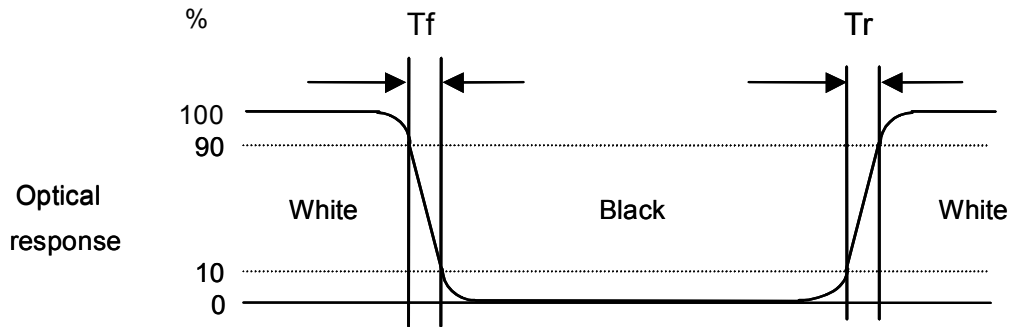

Note 7: Definition of viewing angle

Viewing angle is the measurement of contrast ratio 10, at the screen center, over a 180° horizontal and 180° vertical range (off-normal viewing angles). The 180° viewing angle range is broken down as below: 90° ( $\theta$ ) horizontal left and right, and 90° ( $\Phi$ ) vertical high (up) and low (down). The measurement direction is typically perpendicular to the display surface with the screen rotated to its center to develop the desired measurement viewing angle.

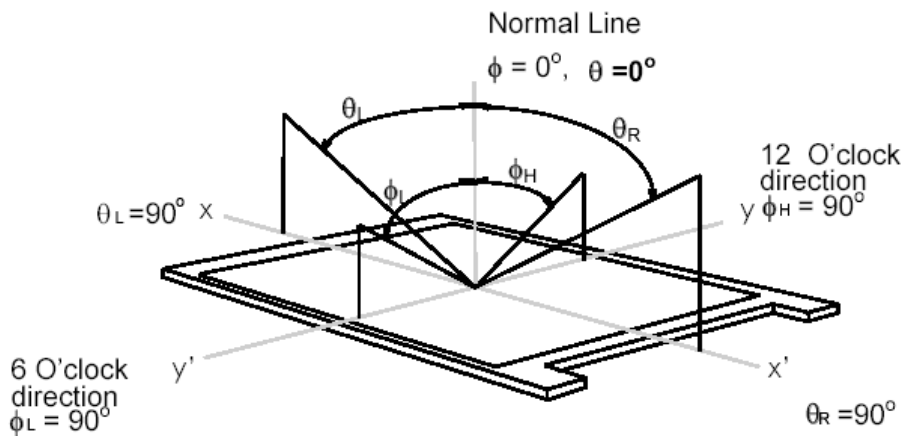

Note 8: Note 8: Definition of Gamma Value

Generally, Gamma Value is defined as the slope of a Gray Level – Luminance curve in log-log space, that is

$$= d \log(\text{Luminance}) / d \log(\text{Gray Level})$$

The Gamma Value defined in this spec is Linear Regression ( 1, 2, 3..., 16). 1 to 16 are the section gamma of the following 17 sampling points, GL(0), GL(16), GL(32), GL(48), GL(64), GL(80), GL(96), GL(112), GL(128), GL(144), GL(160), GL(176), GL(192), GL(208), GL(224), GL(240) and GL(255), in 8 bits input.

### 3. Functional Block Diagram

The following diagram shows the functional block of the 15 inch color TFT/LCD module:

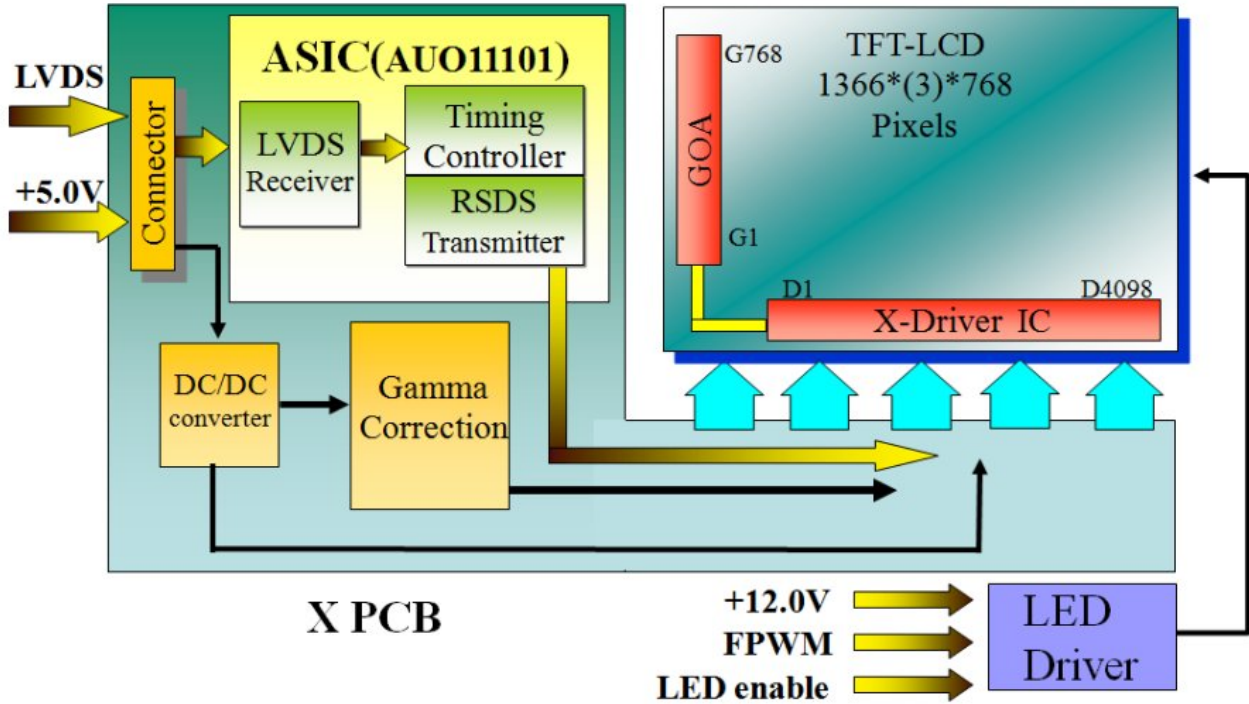

#### I/F PCB connector:

JAE / FI-XB30SSL-HF15  
STM / MSBKT2407P30HB

#### Housing Type:

FI-X30HL (Locked Type)

## 4. Absolute Maximum Ratings

### 4.1 Absolute Ratings of TFT LCD Module

Item	Symbol	Min	Max	Unit	Conditions
Logic/LCD Drive Voltage	Vin	0	6.0	[Volt]	<i>Note 1,2</i>

### 4.2 Absolute Ratings of Touch Sensor

Item	Symbol	Rating	Unit	Conditions
Voltage from VCCIO to AGND and DGND	-	+6.0	[Volt]	-
Voltage from any pin to AGND and DGND	-	+4.0	[Volt]	-

### 4.3 Absolute Ratings of Environment

Item	Symbol	Min.	Max.	Unit	Conditions
Operating Temperature	TOP	0	+60	[°C]	<i>Note 3</i>
Operation Humidity	HOP	5	90	[%RH]	
Storage Temperature	TST	-20	+60	[°C]	
Storage Humidity	HST	5	90	[%RH]	

Note: Maximum Wet-Bulb should be 39 and no condensation.

**Note 1:** With in Ta (25 °C)

**Note 2:** Permanent damage to the device may occur if exceeding maximum values

**Note 3:** For quality performance, please refer to AUO IIS(Incoming Inspection Standard).

**Note 4:** Operation Temperature + 60°C is defined as panel surface temperature.

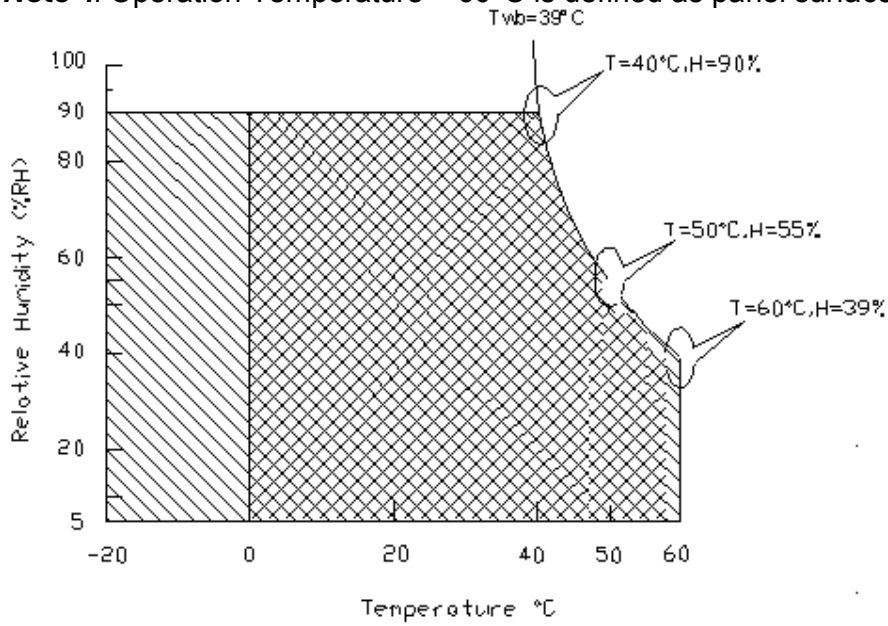

Operating Range  Storage Range  + 

## 5. Electrical Characteristics

### 5.1 TFT LCD Module

#### 5.1.1 Power Specification

Symbol	Parameter	Min	Typ	Max	Unit	Conditions
VDD	Logic/LCD Drive Voltage	4.5	5.0	5.5	[Volt]	+/-10%
IDD	Input Current	-	0.43	0.52	[A]	VDD= 5.0V, All Black Pattern At 60Hz
PDD	VDD Power	-	2.15	2.6	[Watt]	VDD= 5.0V, All Black Pattern At 60Hz
IRush	Inrush Current	-	-	2.5	[A]	<b>Note 1</b>
VDDrp	Allowable Logic/LCD Drive Ripple Voltage	-	-	300	[mV] p-p	VDD= 5.0V, All Black Pattern At 60Hz

**Note 1:** Measurement conditions:

The duration of rising time of power input is 470 us.

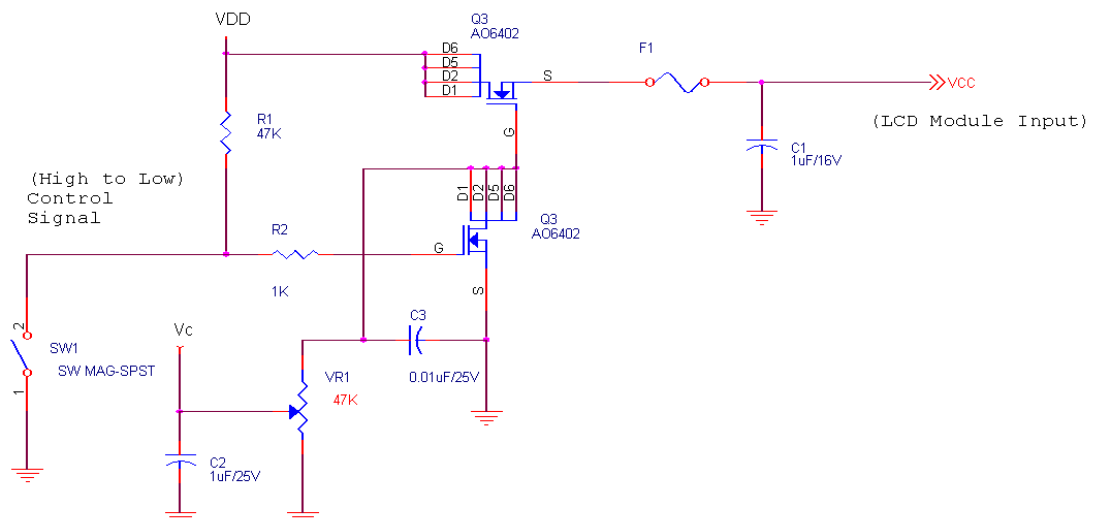



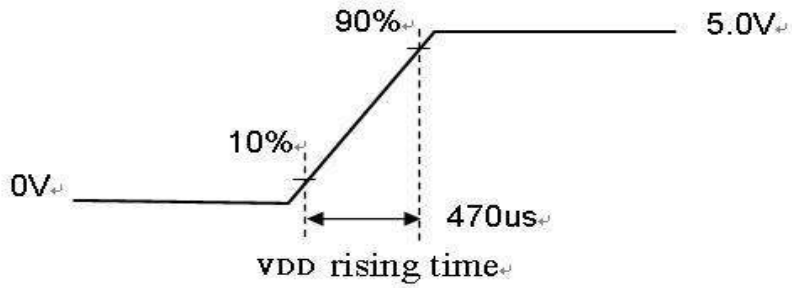

### 5.1.2 Signal Electrical Characteristics

Input signals shall be low or Hi-Z state when VDD is off.

Symbol	Parameter	Min	Typ	Max	Units	Condition
VTH	Differential Input High Threshold	-	+50	+100	[mV]	VICM = 1.2V <b>Note 1</b>
VTL	Differential Input Low Threshold	-100	-50	-	[mV]	VICM = 1.2V <b>Note 1</b>
VID	Input Differential Voltage	100	-	600	[mV]	<b>Note 1</b>
VICM	Differential Input Common Mode Voltage	+1.0	+1.2	+1.5	[V]	VTH-VTL = 200mV (max) <b>Note 1</b>

Note: LVDS Signal Waveform.

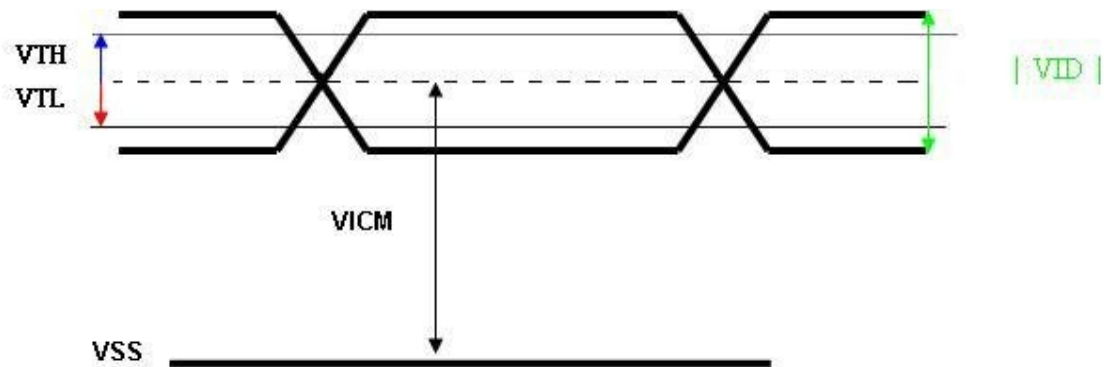

## 5.2 Backlight Unit

Following characteristics are measured under stable condition using a LED driving board at 25 (Room Temperature).

Symbol	Parameter	Min	Typ	Max	Unit	Remark
Vcc	Input Voltage	10.8	12	13.2	Volt	
Ivcc	Input Current	-	0.5	0.6	A	100% Dimming
PLED	Power Consumption	-	6	7.2	Watt	100% Dimming
FPWM	PWM Dimming Frequency	200	-	20k	Hz	
	Swing Voltage	3	3.3	5	V	
	Dimming Duty Cycle	5	-	100	%	
Enable	High-level	2.5			V	
	Low-level			0.5	V	
I <sub>F</sub>	LED Forward Current	-	50		mA	Ta = 25°C, Note 4
Operating Life		50000	-	-	Hrs	Ta = 25°C

Note 1: Ta means ambient temperature of TFT-LCD module.

Note 2: If G156XW01 module is driven at high ambient temperature & humidity condition. The operating life will be reduced.

Note 3: Operating life means brightness goes down to 50% initial brightness. Min. operating life time is estimated data.

Note 4: I<sub>F</sub> are defined for one channel LED. There are four LED channel in back light unit.

## 5.3 Touch Sensor

### 5.3.1 Power Specification

Items	Symbol	Specifications			Unit	Notes
		Min.	Typ.	Max.		
Touch Panel Power Supply	VTSP	4.5	5	5.5	V	Ripple <100mV
Input voltage	VIH	VCCIOx0.7	-	VCCIO	V	VCCIO= 1.8V or 3.3V
	VIL	0	-	VCCIOx0.3	V	

Normal mode Current consumption @ Report rate 100Hz	INORMAL	75	80	85	mA	
Idle mode Current consumption	IIDLE	40	50	60	mA	
Sleep mode Current consumption	ISLEEP	-			uA	

## 6. Signal Characteristic

### 6.1 Pixel Format Image

Following figure shows the relationship between input signal and LCD pixel format.

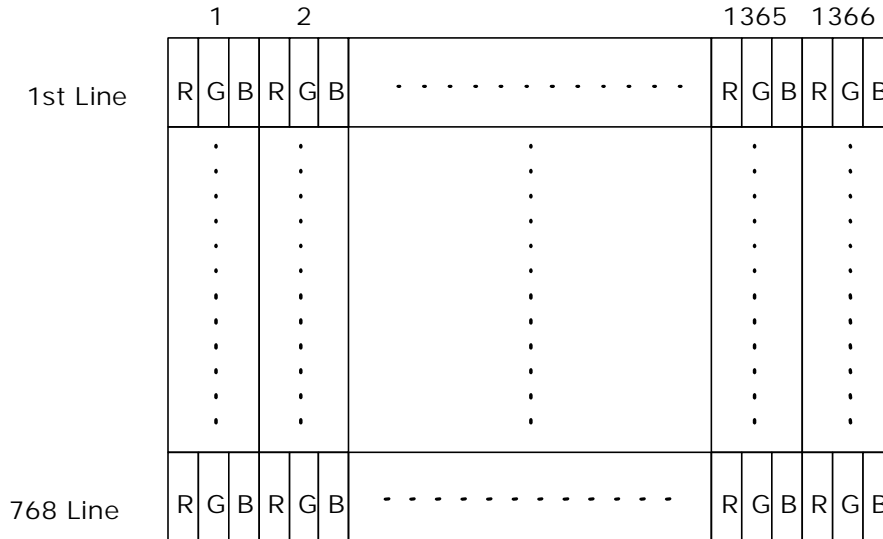

### 6.2 The input data format

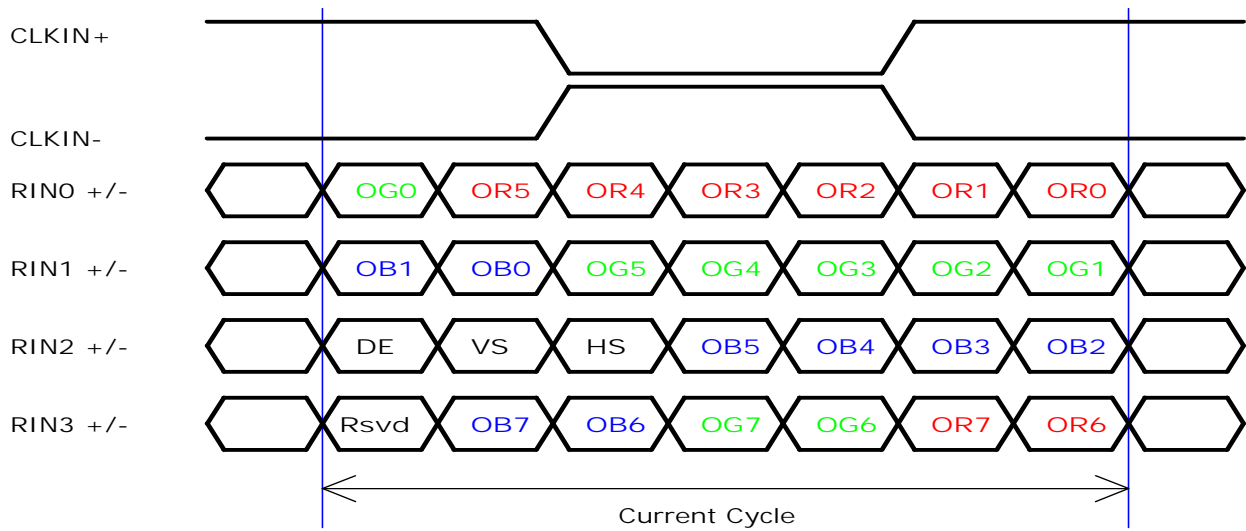

**Note 1:** R/G/B data 7:MSB, R/G/B data 0:LSB

### 6.3 Signal Description

The module using one LVDS receiver SN75LVDS82(Texas Instruments). LVDS is a differential signal technology for LCD interface and high speed data transfer device. LVDS transmitters shall be SN75LVDS83(negative edge sampling). The first LVDS port(RxOxxx) transmits odd pixels while the second LVDS port(RxExxx) transmits even pixels.

LVDS is a differential signal technology for LCD interface and high speed data transfer device.

PIN #	SIGNAL NAME	DESCRIPTION
1	Reserved	No Connection
2	Reserved	No Connection
3	Reserved	No Connection
4	GND	Ground
5	RXIN0-	-LVDS Differential Data Input, CH0
6	RXIN0+	+LVDS Differential Data Input, CH0
7	GND	Ground
8	RXIN1-	-LVDS Differential Data Input, CH1
9	RXIN1+	+LVDS Differential Data Input, CH1
10	GND	Ground
11	RXIN2-	-LVDS Differential Data Input, CH2
12	RXIN2+	+LVDS Differential Data Input, CH2
13	GND	Ground
14	RXCLKIN-	-LVDS Differential Clock Input, CH3
15	RXCLKIN+	+LVDS Differential Clock Input, CH3
16	GND	Ground
17	RXIN3-	-LVDS Differential Data Input, CH3
18	RXIN3+	+LVDS Differential Data Input, CH3
19	GND	Ground
20	Reserved	Internal used (recommend no connection )
21	Reserved	Internal used (recommend no connection )
22	Reserved	Internal used (recommend no connection )
23	GND	Ground
24	GND	Ground
25	GND	Ground
26	AVDD	Power +5V, (typical)
27	AVDD	Power +5V, (typical)
28	AVDD	Power +5V, (typical)
29	AVDD	Power +5V, (typical)
30	AVDD	Power +5V, (typical)

Note 1

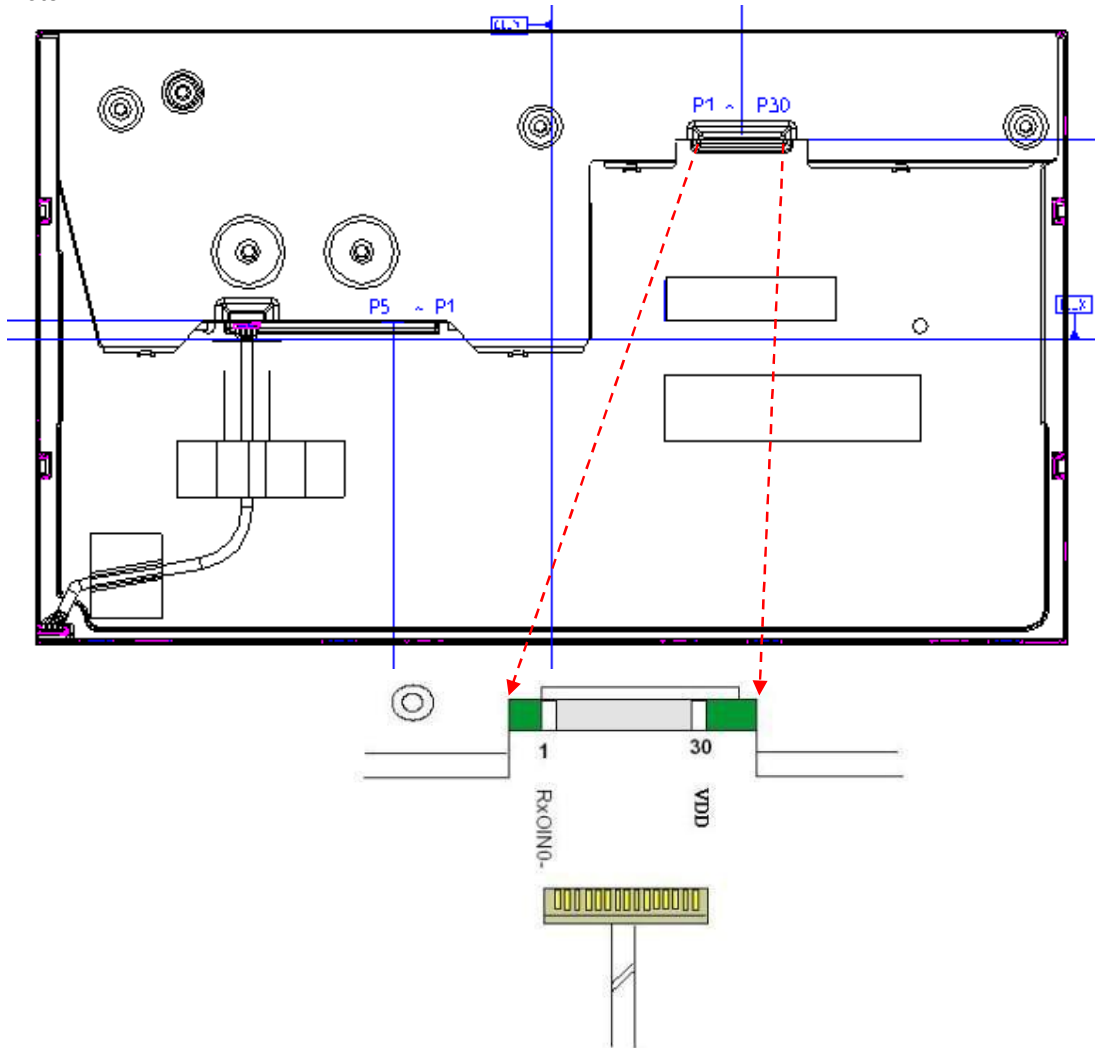

## 6.4 Timing Characteristics

Basically, interface timing described here is not actual input timing of LCD module but close to output timing of SN75LVDS82DGG (Texas Instruments) or equivalent.

Item		Symbol	Min	Typ	Max	Unit
Data CLK		Tclk	60	76	90	[MHz]
H-section	Period	Th	1446	1566	1936	[Tclk]
	Display Area	Tdisp(h)	1366	1366	1366	[Tclk]
	Blanking	Tblk(h)	80	200	570	[Tclk]
V-section	Period	Tv	778	806	888	[Th]
	Display Area	Tdisp(v)	768	768	768	[Th]
	Blanking	Tblk(v)	10	38	120	[Th]
Frame Rate		F	50	60	75	[Hz]

**Note** : DE mode only

### 6.5 I Input Timing Diagram

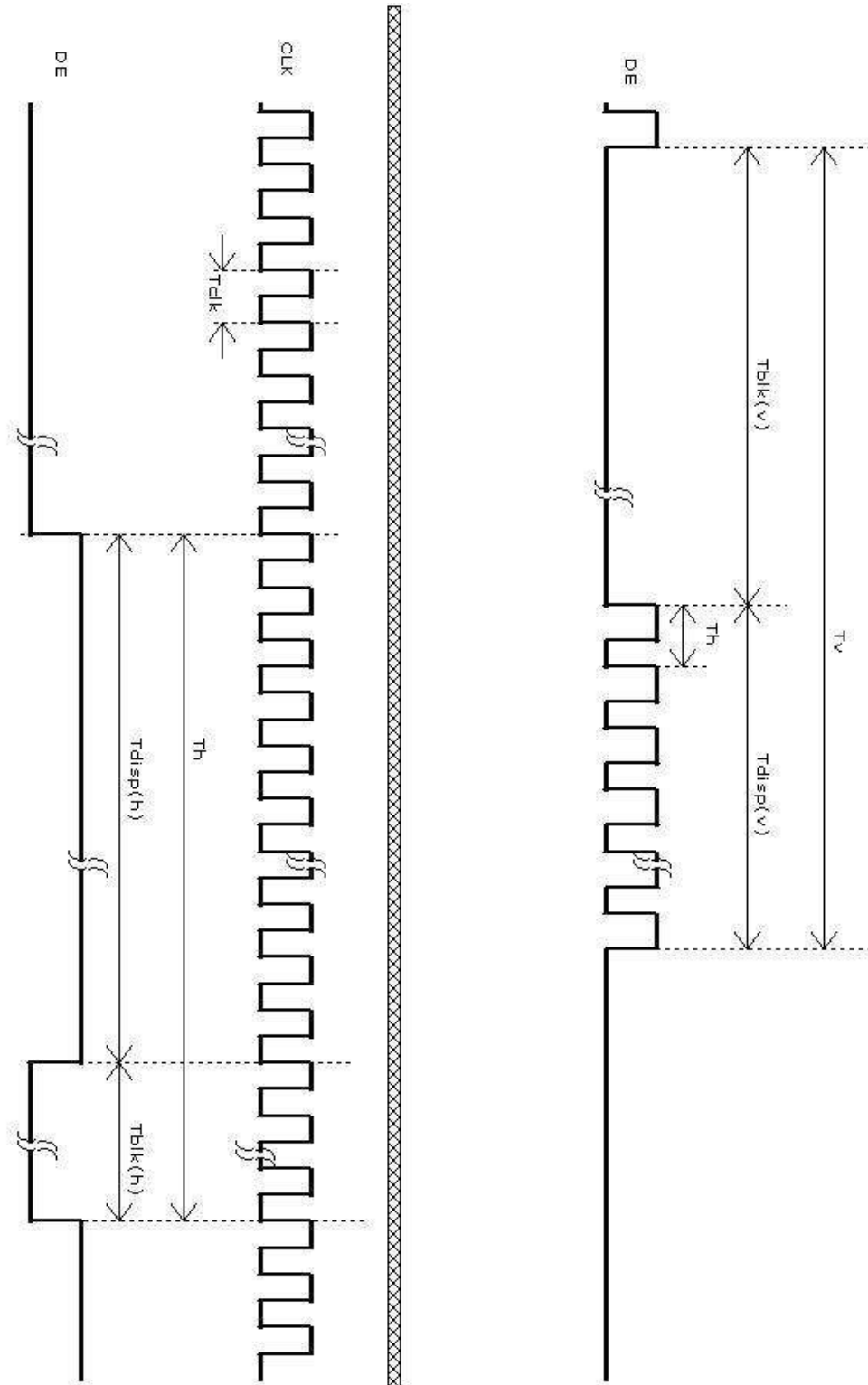



### 6.6 Power ON/OFF Sequence

VDD power and LED on/off sequence are as follows. Interface signals are also shown in the chart. Signals from any system shall be Hi-Z state or low level when VDD is off.

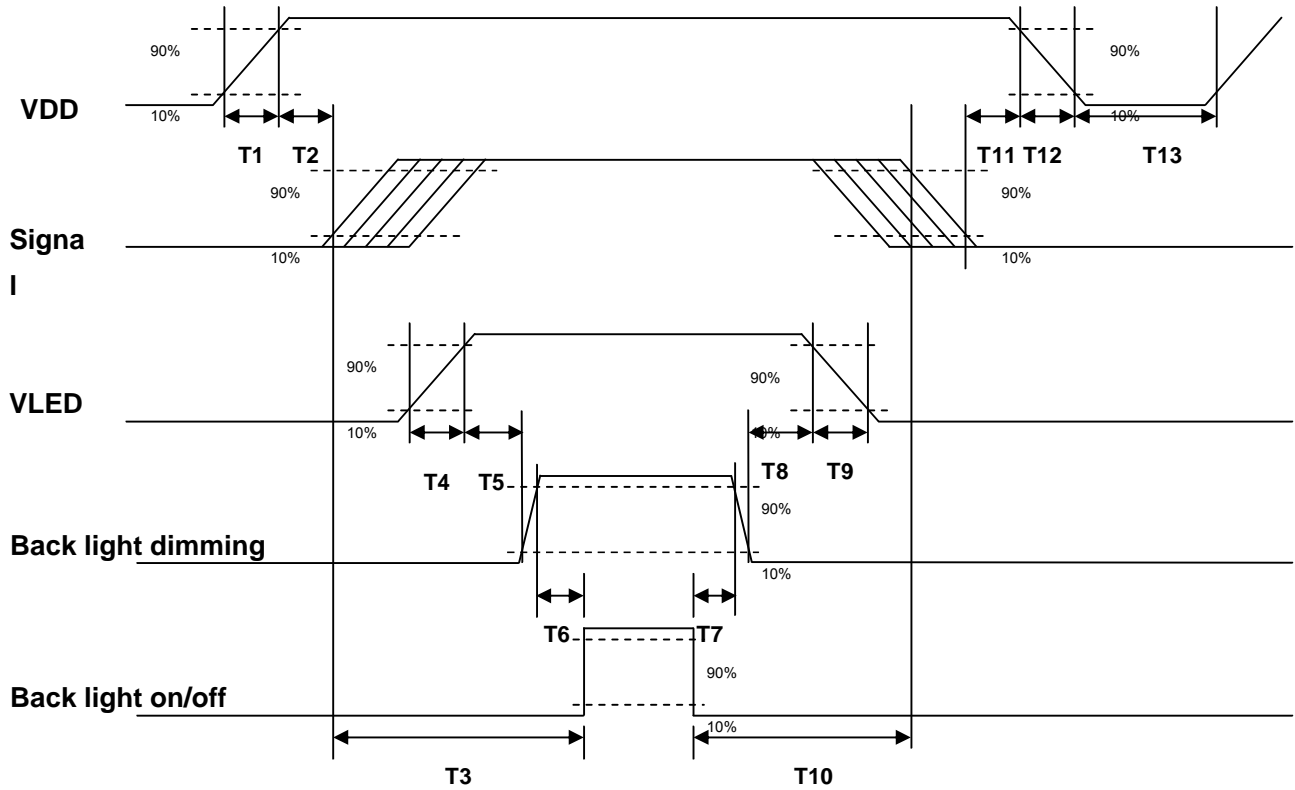

Parameter	Value			Units
	Min.	Typ.	Max.	
T1	0.5	-	10	[ms]
T2	0	40	50	[ms]
T3	200	-	-	[ms]
T4	0.5	-	10	[ms]
T5	10	-	-	[ms]
T6	10	-	-	[ms]
T7	0	-	-	[ms]
T8	10	-	-	[ms]
T9	-	-	10	[ms]
T10	110	-	-	[ms]
T11	0.5	16	50	[ms]
T12	-	-	100	[ms]
T13	1000	-	-	[ms]

The above on/off sequence should be applied to avoid abnormal function in the display. Please make sure to turn off the power when you plug the cable into the input connector or pull the cable out of the connector.

## 7. Connector & Pin Assignment

Physical interface is described as for the connector on module. These connectors are capable of accommodating the following signals and will be following components.

### 7.1 TFT-LCD Signal: LVDS Interface

Connector Name / Designation	Interface Connector / Interface card
Manufacturer	JAE STM
Type Part Number	FI-XB30SSL-HF15 MSBKT2407P30HB
Mating Housing Part Number	FI-X30HL (Locked Type)

#### 7.1.1 Pin Assignment

Pin#	Signal Name	Pin#	Signal Name
1	Reserved	2	Reserved
3	Reserved	4	GND
5	RXIN0-	6	RXIN0+
7	GND	8	RXIN1-
9	RXIN1+	10	GND
11	RXIN2-	12	RXIN2+
13	GND	14	RXCLKIN-
15	RXCLKIN+	16	GND
17	RXIN3-	18	RXIN3+
19	GND	20	Reserved
21	Reserved	22	Reserved
23	GND	24	GND
25	GND	26	AVDD
27	AVDD	28	AVDD
29	AVDD	30	AVDD

## 7.2 T Backlight Unit

Physical interface is described as for the connector on module. These connectors are capable of accommodating the following signals and will be following components.

Connector Name / Designation	LED Connector
Manufacturer	E&T or compatible
Connector Model Number	3808K-F05N-12R or compatible
Mating Connector Model Number	H208K-D05N-22B or compatible

### 7.2.1 T Backlight Unit

Pin#	Symbol	Signal Name
1	Vcc	12V
2	GND	GND
3	Enable	LED enable
4	Dimming	PWM Dimming
5	NC	NC

## 7.3 Touch Signal : USB Interface

Connector Name / Designation	TP Connector
Manufacturer	E & T Corporation
Type / Part Number	3802K-E05N-01R (From FPCa) H201K-D05N-12B (From System)

Pin#	Symbol	Signal Name
1	GND	Ground
2	VDD	Power 5V
3	GND	Ground
4	D+	USB D+
5	D-	USB D-

## 7.4 Touch Connector Illustration

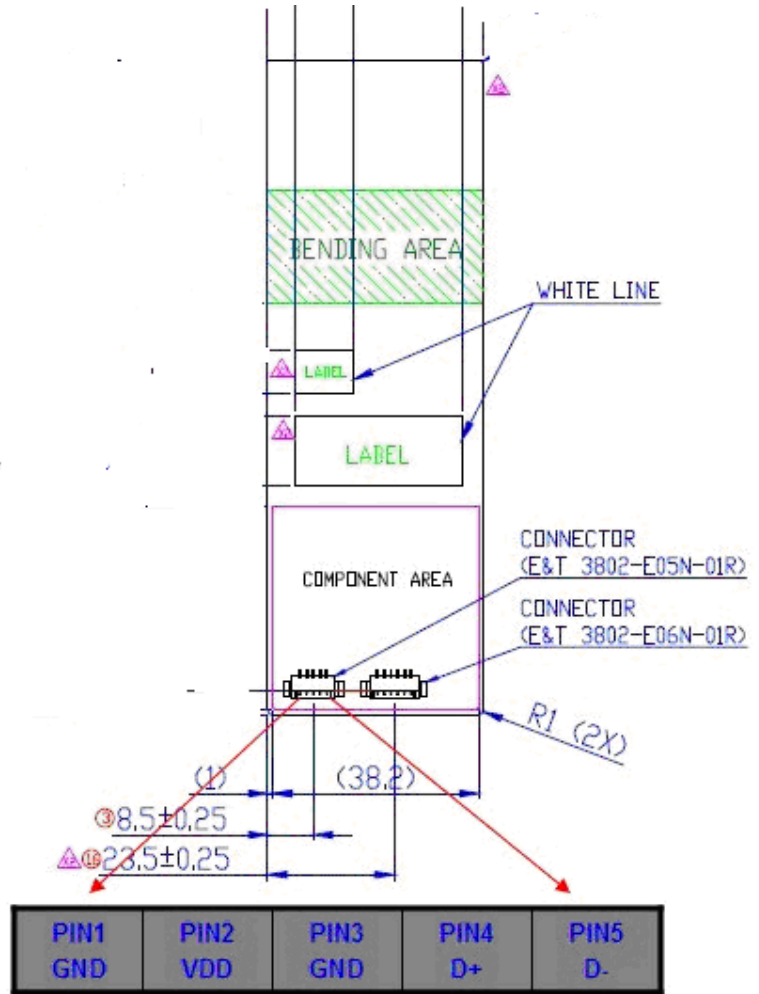
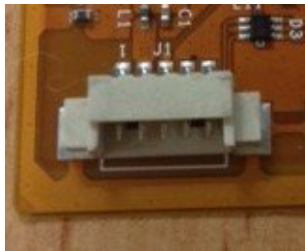

### 8. Reliability Test Criteria

Items	Required Condition	Note
Temperature Humidity Bias (THB)	Ta= 50 °C, 80%RH, 300hours	
High Temperature Operation (HTO)	Ta= 60 °C, 300hours, For panel surface temp.	
Low Temperature Operation (LTO)	Ta= 0 °C, 300hours	
High Temperature Storage (HTS)	Ta= 60 °C, 300hours	
Low Temperature Storage (LTS)	Ta= -20 °C, 300hours	
Vibration Test (Non-operation)	Acceleration: 1.5 Grms Wave: sine Frequency: 10 - 200 Hz Duration: 30 Minutes each Axis (X, Y, Z)	
Shock Test (Non-operation)	Acceleration: 50 G Wave: Half-sine Active Time: 20 ms Direction: ±X, ±Y, ±Z (one time for each Axis)	
Drop Test	Height: 46 cm, package test	
Thermal Shock Test (TST)	-20 °C /30min, 60 °C /30min, 100 cycles	<b>1</b>
On/Off Test	On/10sec, Off/10sec, 30,000 cycles	
ESD (Electro Static Discharge)	Contact Discharge: ± 8KV, 150pF(330Ω ) 1sec, 15 points, 25 times/ point.	<b>2</b>
	Air Discharge: ± 15KV, 150pF(330Ω ) 1sec 15 points, 25 times/ point.	
Altitude Test	Operation:10,000 ft Non-Operation:30,000 ft	

**Note 1:** The TFT-LCD module will not sustain damage after being subjected to 100 cycles of rapid temperature change. A cycle of rapid temperature change consists of varying the temperature from -20 °C to 60 °C, and back again. Power is not applied during the test. After temperature cycling, the unit is placed in normal room ambient for at least 4 hours before power on.

**Note 2:** EN61000-4-2, ESD class B: Certain performance degradation allowed  
 No data lost  
 Self-recoverable  
 No hardware failures.

## 9. Mechanical Characteristics

### 9.1 Total solution Outline Dimension (Front View)

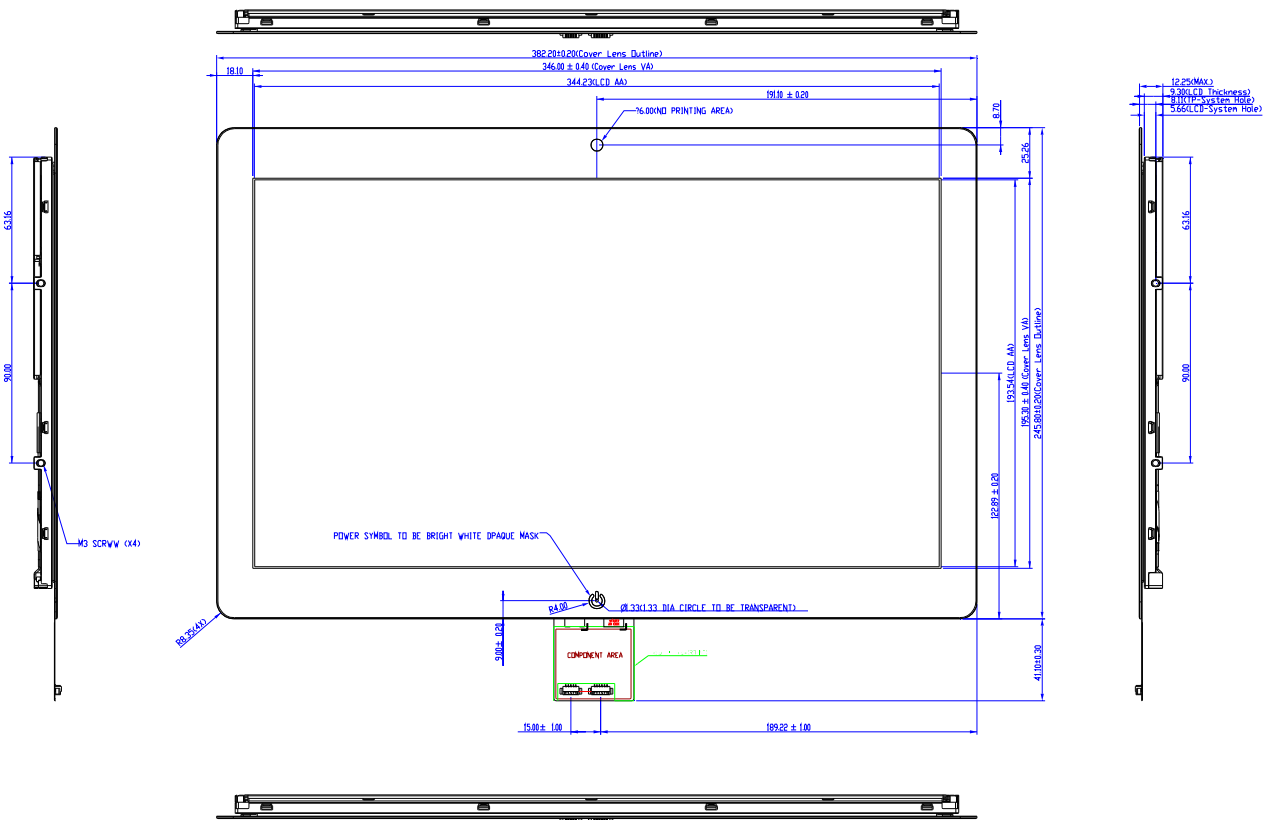

## 9.2 Total solution Outline Dimension (Rear View)

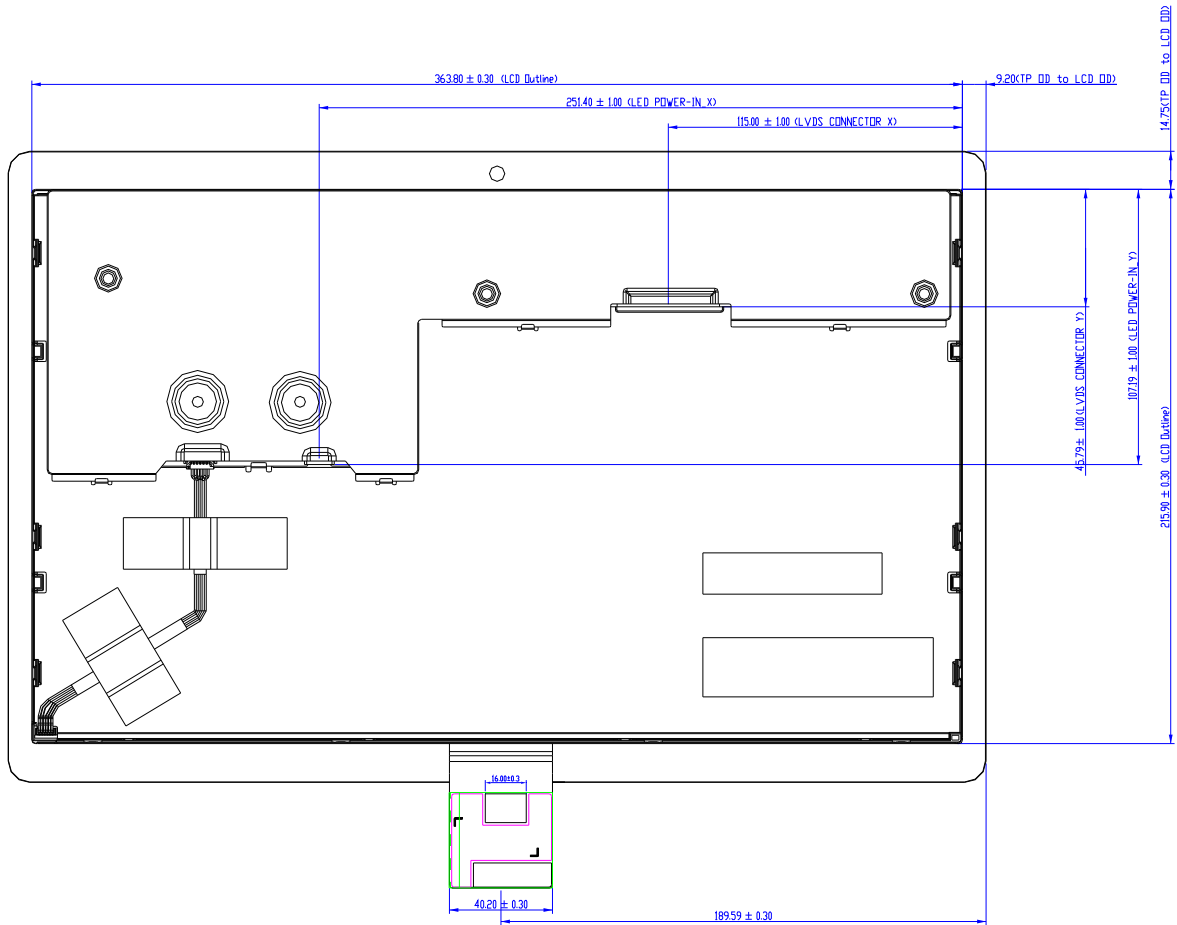



## 10. Label and Packaging

### 10.1 Shipping Label (on the rear side of TFT-LCD display)

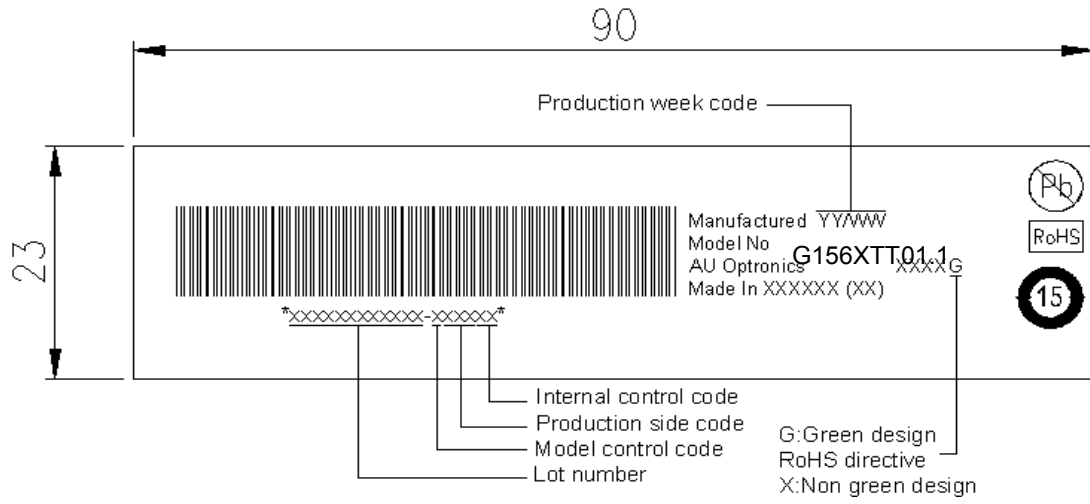

## 10.2 Carton Package

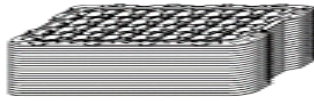
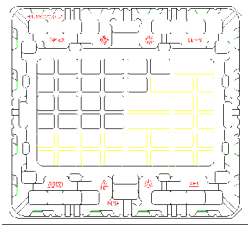

5. 一叠 tray 堆 5+1 层, 最上层为空 tray, 上下 2 层 tray 之间要旋转 180 度堆叠

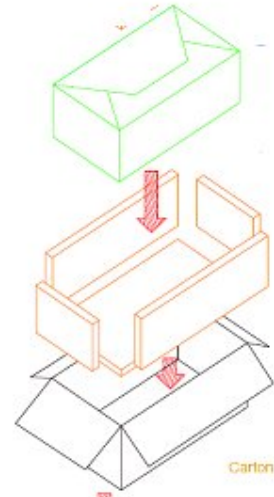

8. 放外围缓冲 EPE 并放入第 1 包

1. 取 1pcs 空 Tray

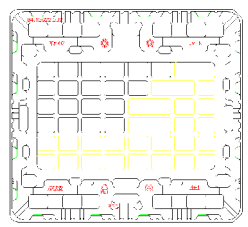

2. 放 1pcs EPE 于 tray 中

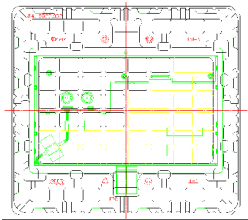

3. 放 1pcs 模组于 EPE 上, TP 朝下

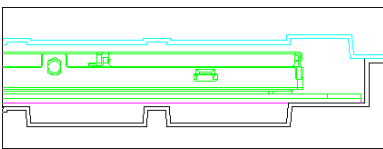

4. 每 tray total 1pcs EPE+1pcs 模组

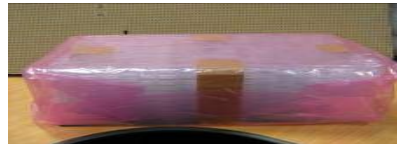

6. 把叠摞 tray 放入静电袋中 并用透明胶带封

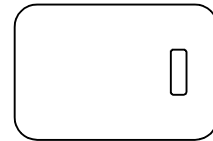

9. 第 1、2 包 tray 之间放入纸隔板



10. 放入第 2 包 tray+模组  
放入最上层 EPE

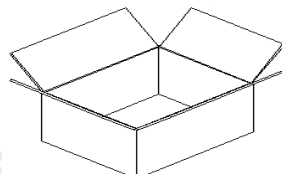
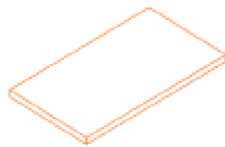
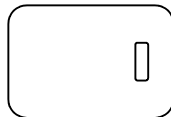
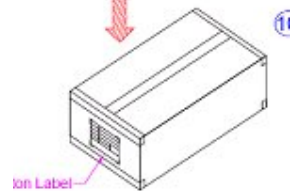

7. 纸箱内分别放入 EPE 缓冲和纸隔板, 纸隔板在 EPE 上

### 10.3 Palletizing

Max capacity : 24 TFT-LCD module per carton

Max weight: 11.5kg per carton

Outside dimension of carton:523mm(L)\* 483mm(W)\*277mm(H)

Pallet size : 1150 mm \* 980mm \* 132mm

#### Box stacked

Module by air : (2 \*2) \*5 layers , one pallet put 20 boxes , total 480pcs module

Module by sea : (2 \*2) \*5 layers + (2 \*2) \*1 layers , two pallet put 24 boxes , total 576 pcs module

Module by sea\_HQ : (2 \*2) \*5 layers+(2 \*2) \*2 layers, two pallet put 28boxes, total 672 pcs module

#### Palletizing

	MAX SHIPPING BY AIR	MAX SHIPPING BY SEA	MAX SHIPPING BY SEA_HQ
MODULE/CARTON	20	20	20
CARTON/LAYER	4	4	4
LAYER/PALLET	5	5+1	5+2
MODULE/PALLET	400	480	560
CARTON SIZE(MM)	523(L)*483(W)*277(H)	523(L)*483(W)*277(H)	523(L)*483(W)*277(H)
PALLET SIZE(MM)	1150(L)*980(W)*132(H)	1150(L)*980(W)*132(H)	1150(L)*980(W)*132(H)
TOTAL PALLET HEIGHT(MM)	1517	1926	2203
TOTAL PALLET WEIGHT(KG)	200	250	288

ONE PALLET SHIPMENT EXAMPLE SHIPPING BY AIR USED

TWO PALLET'S SHIPMENT EXAMPLE SHIPPING BY SEA USED

TWO PALLET'S SHIPMENT EXAMPLE SHIPPING BY SEA\_HQ USED