

TFT-PCAP-Modul Datenblatt

Modell SCF0403526GGU19

Kurzdaten

Hersteller	Data Image
Diagonale	4,3" / 10,9 cm
Format	wide
Auflösung	480 x 272
Backlight	LED / 340 cd/m ²
Interface	RGB
Touchscreen	ja
Temperatur	-20... +70°C (Betrieb)



Confidential Document

DATA IMAGE CORPORATION
CTP Module Specification
PRELIMINARY
 ITEM NO.: SCF0403526GGU19

Table of Contents

1. COVER & CONTENTS	1
2. RECORD OF REVISION	2
3. GENERAL SPECIFICATIONS.....	3
4. LCD ELECTRICAL CHARACTERISTICS	3
5. BACKLIGHT POWER CONDITIONS.....	3
6. BLOCK DIAGRAM	4
7. LCD PIN CONNECTIONS	5
8. LCD AC CHARACTERISTICS	6
9. CTP INTERFACE AND DATA FORMAT.....	9
10. CTP COMMAND	14
11. OPTICAL CHARACTERISTIC	24
12. QUALITY ASSURANCE	26
13. LCM PRODUCT LABEL DEFINE	30
14. PRECAUTIONS IN USE LCM	32
15. OUTLINE DRAWING	33
16. PACKAGE INFORMATION	34

Customer Companies	R&D Dept.	Q.C. Dept.	Eng. Dept.	Prod. Dept.
	ALEX	JOE	GARY	KEN
Approved by	Version:	Issued Date:	Sheet Code:	Total Pages:
	1	26/MAR/13'		34

2. RECORD OF REVISION

Rev	Date	Item	Page	Comment
1	26/MAR/13'			Initial preliminary

3. GENERAL SPECIFICATIONS

Composition: 4.3 inch WQVGA resolution display with a projected Capacitive Touch Panel (CTP).
Interface : 24 bit parallel RGB for panel and I²C for the CTP.

Parameter	Specifications	Unit
Display resolution	480 X 272	pixel
Screen size	4.3(Diagonal)	inch
Outline dimension	110.5 (W) x 72.7(H) x 5(D)	mm
Display active area	95.04(W) x 53.856(H)	mm
Sensor active area	98.7(W) x 57.5(H)	mm
Dot pitch	0.066 (W) x 0.198(H)	mm
Color configuration	R.G.B. Stripe	
Surface treatment	Clear	
Weight	TBD	g
View angle direction	6 o'clock	
Operating temperature	Ambient temperature	-20 ~ 70
Storage temperature		-30 ~ 80
Our components and processes are compliant to RoHS standard		

4. LCD ELECTRICAL CHARACTERISTICS

GND=0V, Ta=25°C

Parameter	Symbol	MIN.	Typ.	MAX.	Unit	Remark
Power supply voltage	V _{DD}	3.0	3.3	3.6	V	Note1
Power supply current	I _{DD}		21	30	mA	V _{DD} =3.3V
Ripple voltage	V _{RPVDD}			100	mVp-p	
"H" level logical input voltage	V _{IH}	0.7VDD	--	VDD	V	
"L" level logical input voltage	V _{IL}	0	--	0.3VDD	V	

Note1: VDD Absolute Maximum Ratings -0.3V~+5V

5. BACKLIGHT POWER CONDITIONS

Ta= 25 °C

Parameter	Symbol	Min.	Typ.	Max.	Unit	Remark
LED current	I _{LED}	--	20	--	mA	
VLED voltage	V _{LED}	21	23.1	26.6	V	I _{LED} =20mA
LED life time		20,000	30,000		Hours	Note 1

Note 1 under room temperature (25 °C, Humidity 30-60% RH) and IL=20mA.

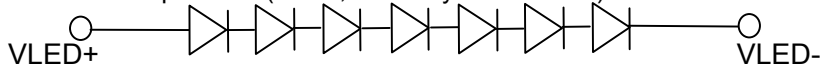

6. BLOCK DIAGRAM

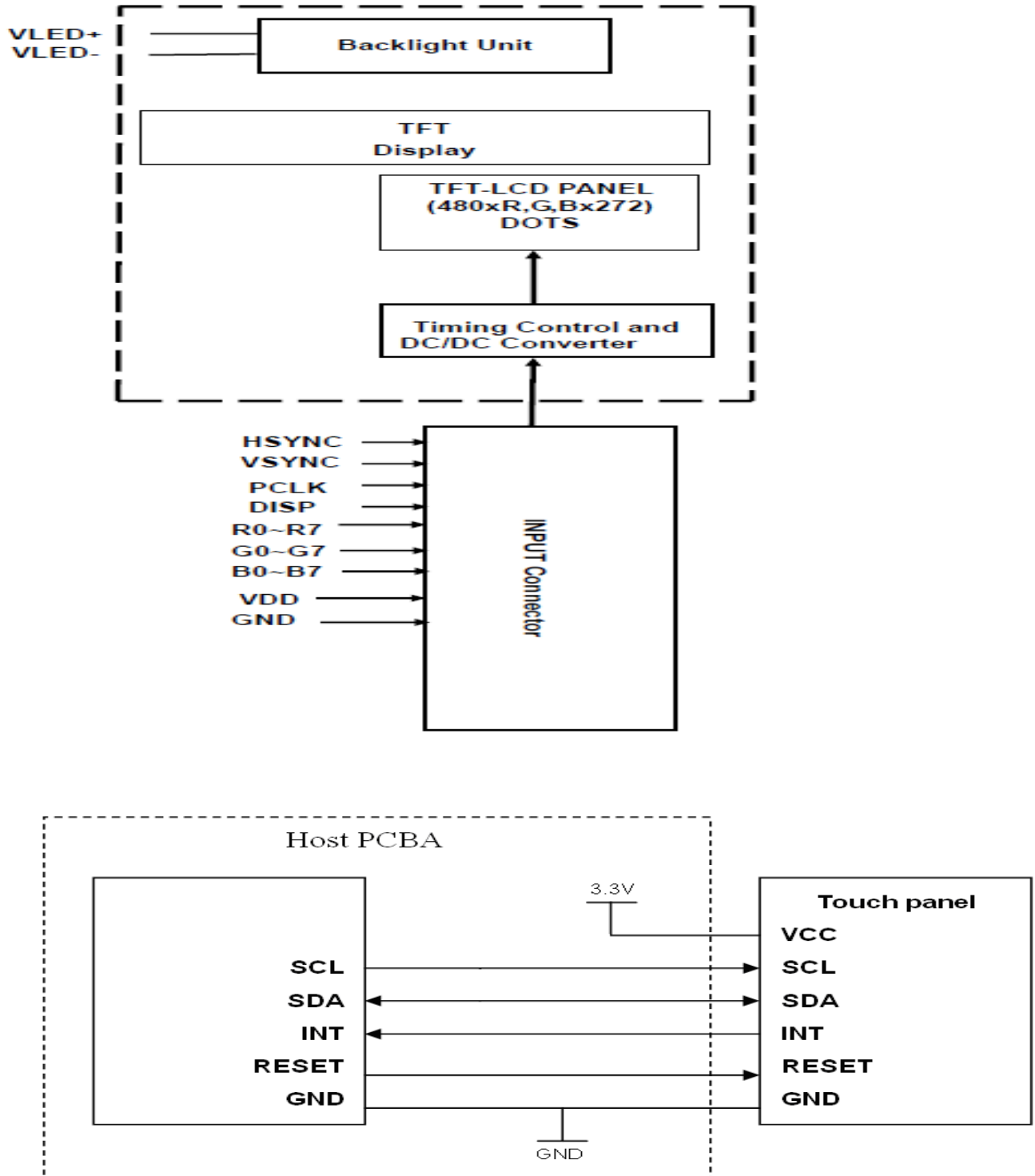

7. LCD PIN CONNECTIONS

Pin No	Symbol	Function	Remark
1	VLED-	LED Power Supply Cathode.	
2	VLED+	LED Power Supply Anode.	
3	NC	No Connection	
4	VDD	Power Supply : +3.3V	
5	R0	Digital data input. R0 is LSB and R7 is MSB	
6	R1		
7	R2		
8	R3		
9	R4		
10	R5		
11	R6		
12	R7		
13	G0	Digital data input. G0 is LSB and G7 is MSB	
14	G1		
15	G2		
16	G3		
17	G4		
18	G5		
19	G6		
20	G7		
21	B0	Digital data input. B0 is LSB and B7 is MSB	
22	B1		
23	B2		
24	B3		
25	B4		
26	B5		
27	B6		
28	B7		
29	GND	Ground	
30	PCLK(CK)	clock signal to sample each data	
31	DISP	Display ON/OFF Control ON=H(VDD), OFF=L(GND)	
32	HSYNC	Horizontal synchronous signal	
33	VSYNC	Vertical synchronous signal	
34	NC	No Connection	
35	NC	No Connection	
36	GND	Ground	
37	NC	No Connection	
38	NC	No Connection	
39	NC	No Connection	
40	NC	No Connection	

8. LCD AC CHARACTERISTICS

8.1 Input Timing Requirement

 (480RGBx272, $T_a = 25^\circ\text{C}$, $V_{DD} = 3.3\text{V}$ $GND = 0\text{V}$)

Parameter	Symbol	Min.	Typ. Value	Max.	Unit
CK frequency	fclk	5	9	12	MHz
VSYNC period time	T_v	282	288	373	H
VSYNC display area	T_{vd}	272			H
VSYNC back porch	T_{vbp}	8	8	8	H
VSYNC front porch	T_{vfp}	2	8	93	H
HSYNC period time	T_h	524	525	585	CK
HSYNC display area	T_{hd}	480			CK
HSYNC back porch	T_{hbp}	40	40	40	CK
HSYNC front porch	T_{hfp}	4	5	65	CK

Vertical input timing

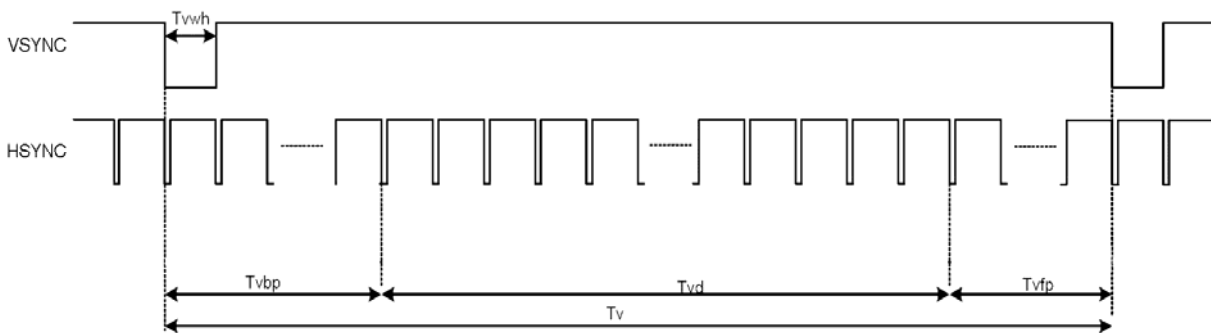

Horizontal input timing

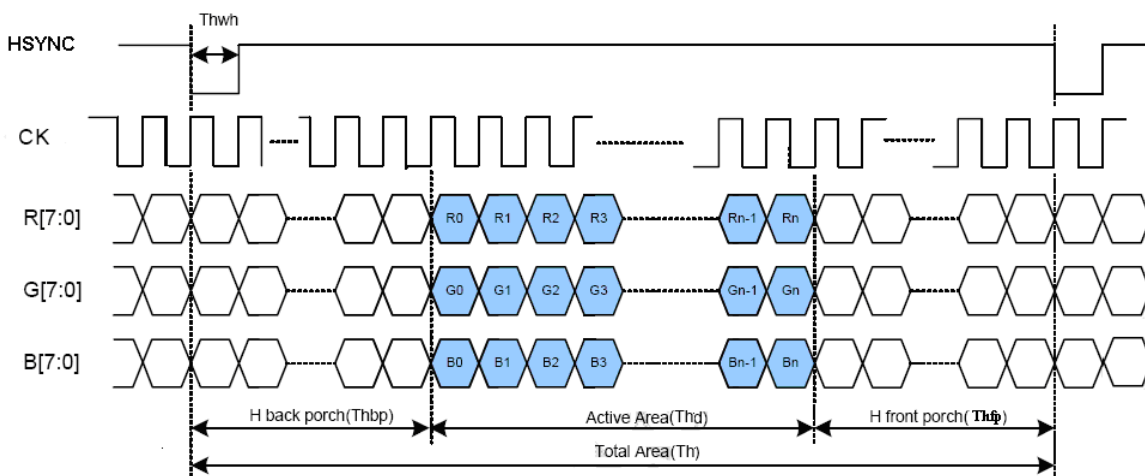

Fig 1. Parallel RGB input timing

8.2 Input Setup Timing Requirement

(VDD = 3.0 to 3.6V, GND=0V, TA=-20 to +85°C)

Parameters	Symbol	Min.	Typ.	Max.	Unit	Conditions
CK clock time	Tclk	33.3	-	-	ns	CK =30MHz
CK clock low period	Tcwl	40	-	60	%	
CK clock high period	Tcwh	40	-	60	%	
Clock rising time	Trck	9	-	-	ns	
Clock falling time	Tfck	9	-	-	ns	
HSYNC width	Thwh	1	-	-	CK	
HSYNC period time	Th	55	60	65	us	
HSYNC setup time	Thsu	12	-	-	ns	
HSYNC hold time	Thhd	12	-	-	ns	
VSYNC width	Tvwh	1	-	-	Th	
VSYNC setup time	Tvsu	12	-	-	ns	
VSYNC hold time	Tvhd	12	-	-	ns	
Data setup time	Tdasu	12	-	-	ns	
Data hold time	Tdahd	12	-	-	ns	

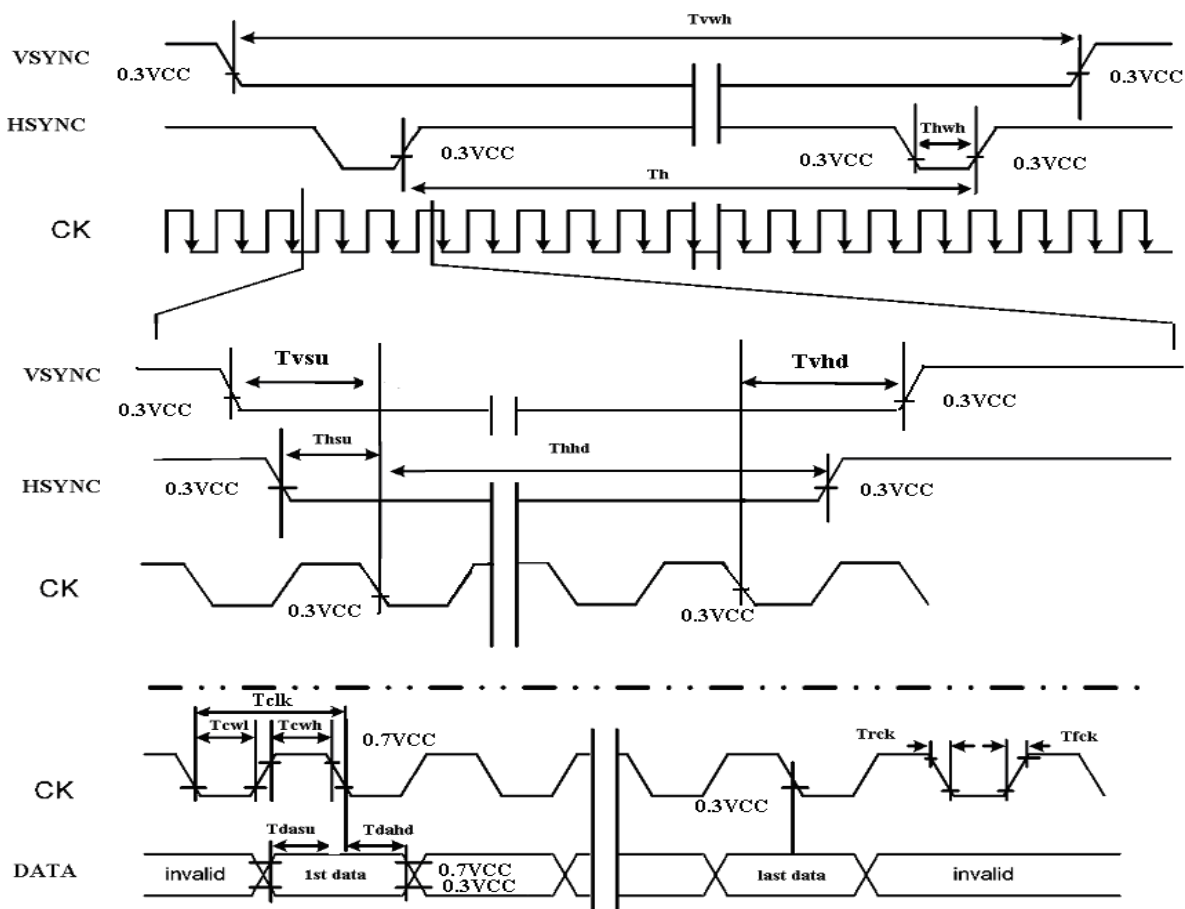
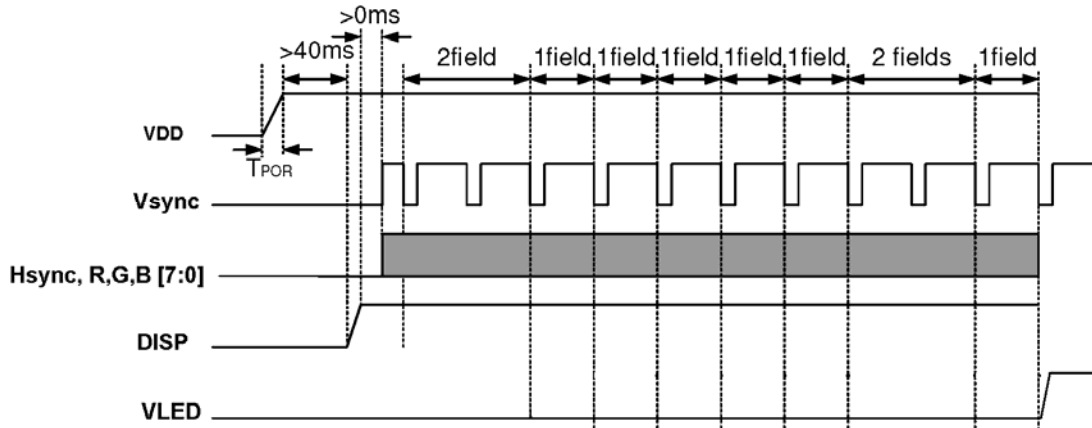

Fig 2. Input setup timing requirement

8.3 Power on/off sequence:

- Power on sequence



- Power off sequence

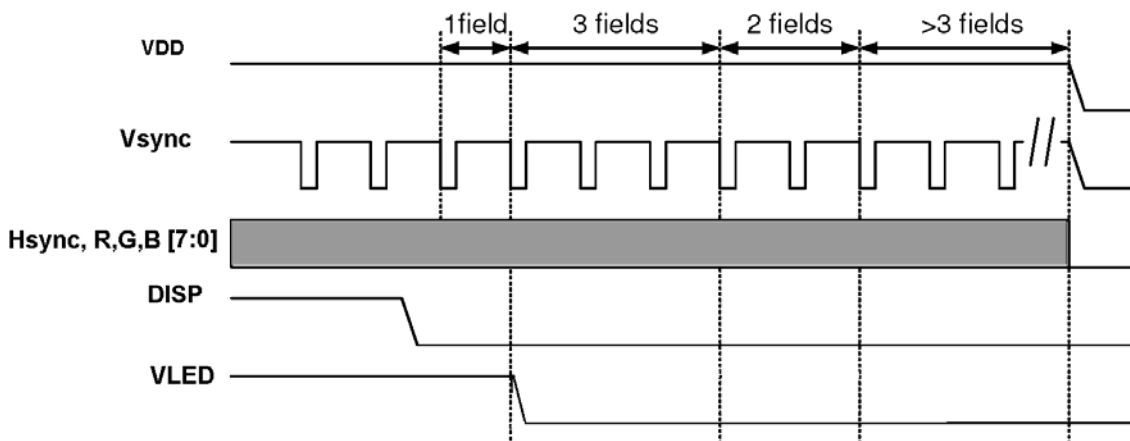

9. CTP INTERFACE AND DATA FORMAT

9.1 GENERAL SPECIFICATIONS

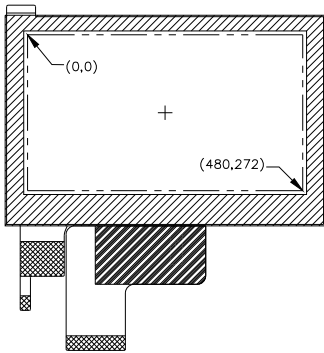
Item	Specification	Unit
Type	Transparent type projected capacitive touch panel	
Input mode	Human's finger	
Multi touch	5	Point
(X,Y) Position		

9.2 CTP Absolute Maximum Rating

Parameter	Symbol	Spec.			Unit
Supply voltage	VDD	-0.3	-	7	V
Switch control signals output current	Output current	-	50	-	mA
Enable control voltage range	Logic Input	-0.3	-	VDD+0.3	V
Output Control Driver	Output voltage	-0.3	-	VDD	V

9.3 CTP Electrical Characteristic

Symbol	Description	Min	Typ	Max	Unit	Notes
VDD	Supply voltage	2.5	3.3	3.5	V	
I _{VDD}	Supply current		14		mA	

9.4 Interface and Data Format (Slave address is 0x94H)

9.4.1 AC characteristics of the SDA and SCL bus lines for I²C-bus devices

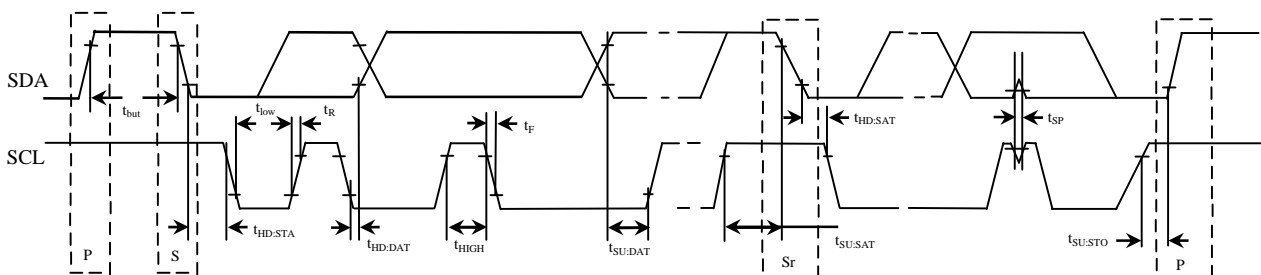

Parameter	Symbol	Standard-Mode I ² C-BUS		Fast-Mode I ² C-BUS		Unit
		Min.	Max.	Min.	Max.	
SCL clock frequency	f_{SCL}	0	100	0	400	KHz
Bus free time between STOP and START condition	t_{BUF}	4.7	-	1.3	-	μ s
Hold time (repeated) START condition. After this period, the first clock pulse is generated	$t_{HD:STA}$	4.0	-	0.6	-	μ s
LOW period of the SCL clock	t_{LOW}	4.7	-	1.3	-	μ s
HIGH period of the SCL clock	t_{HIGH}	4.0	-	0.6	-	μ s
Set-up time for a repeated START condition	$t_{SU:STA}$	4.7	-	0.6	-	μ s
Data hold time	$t_{HD:DAT}$	0	-	0	0.9	μ s
Data set-up time	$t_{SU:DAT}$	250	-	100	-	μ s
Rise time of both SDA and SCL signals	t_R	-	1000	20+0.1C _b	300	μ s
Fall time of both SDA and SCL signals	t_F	-	300	20+0.1C _b	300	μ s
Set-up time for STOP condition	$t_{SU:STO}$	4.0	-	0.6	-	μ s
Capacitive load for each bus line.	C _b	-	400	-	400	pF

Note:

- (1) All values are referred to VIH (0.7xVDD) and VIL (0.3xVDD) level.
- (2) A device must internally provide a hold time of at least 300ns for the SDA signal (referred to the VIH of the SCL signal) in order to bridge the undefined region of the falling edge of SCL.
- (3) The maximum $t_{HD:DAT}$ has only to be met if the device does not stretch the LOW period (t_{LOW}) of the SCL signal.
- (4) A fast-mode I²C-bus device can be used in a standard-mode I²C-bus system, but the requirement $t_{SU:DAT} \geq 250$ ns must then be met. This will automatically be the case if the device does not stretch the LOW period of the SCL signal. If such a device does stretch the LOW period of the SCL signal, it must output the next data bit to the SDA line $t_{R,max} t_{SU:DAT} = 1000+250=1250$ ns (according to the standard-mode I²C-bus specification) before the SCL line is released.
- (5) C_b = total capacitance of one bus line in pF.

9.4.2 Format of Data Frame

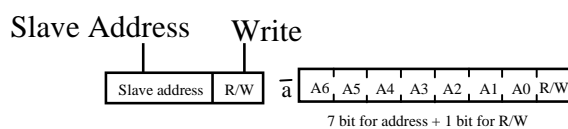
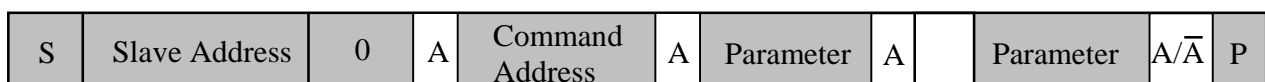
Write mode

From master to slave



From slave to master

Data Format of writing mode

\bar{A} = acknowledge (SDA LOW)
 A = not acknowledge (SDA HIGH)
 S = START condition
 P = STOP condition

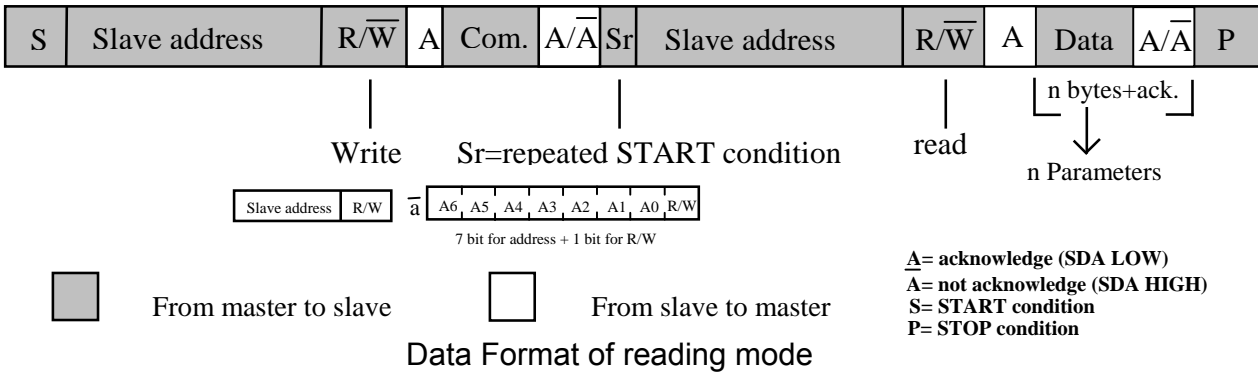
Read mode

9.5 CTP Pin Connections

No.	Name	I/O	Description
1	VDD	-	Power; VDD=3.3V
2	GND	-	Ground
3	/INT	O	Interrupt, Active low
4	SCL	I	Serial clock
5	SDA	I/O	Serial data
6	/RESET	I	Reset, Active LOW.

9.6 Initialize the CTP controller

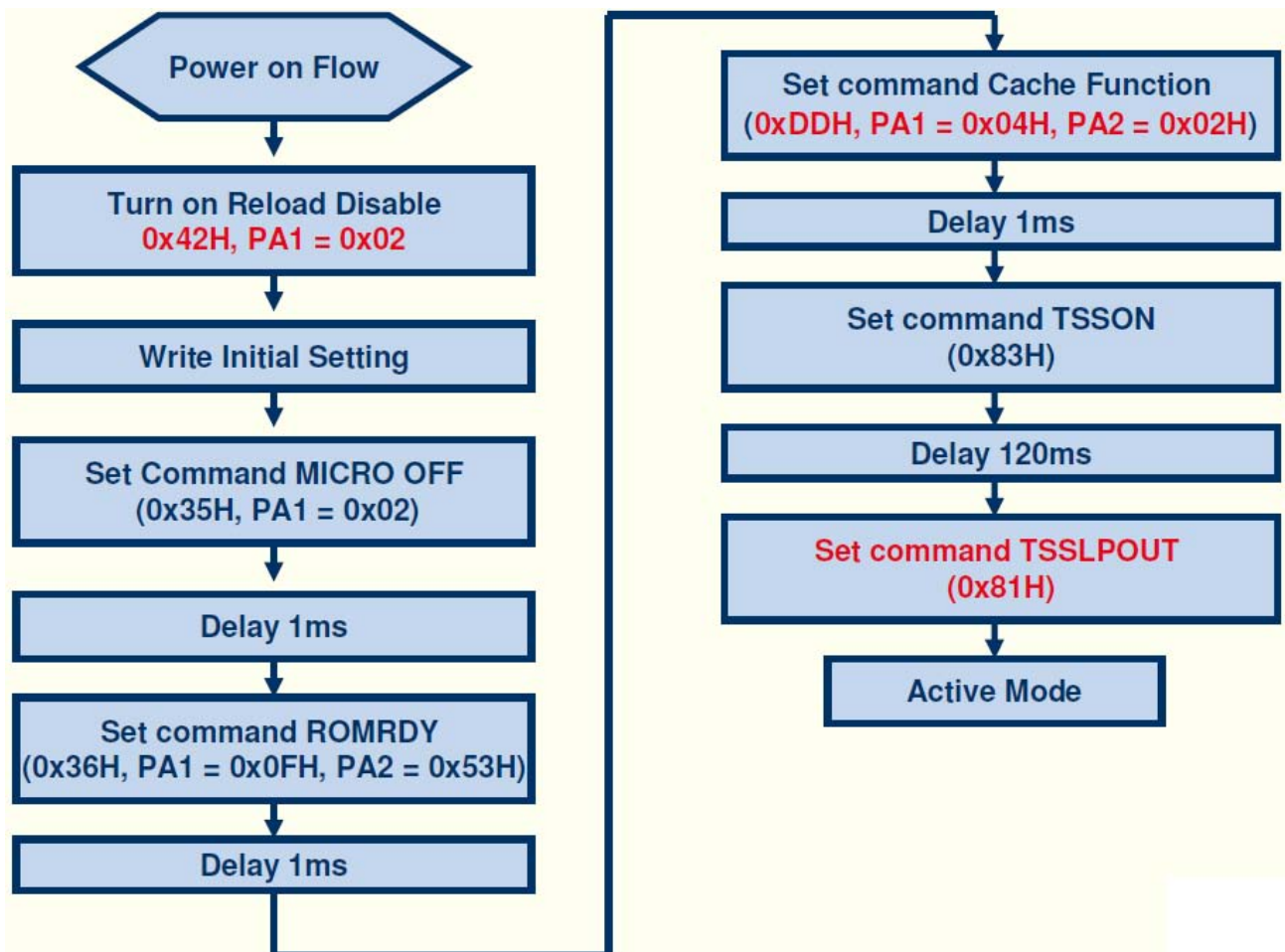
Set Command Reload Disable = 1 (0x42H, PA1 = 0x02)
Write Initial Stetting (This step will only be executed in the first time power on sequence)
Set Command MICRO OFF (0x35H, PA1 = 0x02) to turn on internal MCU
Delay 1ms
Set command ROMRDY (0x36H, PA1 = 0x0FH, PA2 = 0x53H) to turn on internal flash.
Delay 1ms
Set command Cache Function (0xDDH, PA1 = 0x04H, PA2 = 0x02H) (*Note : PA1 is changeable)
Delay 1ms
Set command TSSON (0x83H) to starting touch sensing.
Delay 120ms
Set command TSSLPOUT (0x81H) to turn on internal power.



9.7 Data format

When finger touch, enter event will occurred and coordinate data will be calculated, and than interrupt signal appear (TSIX pull low).

Baseband should receive data when interrupt occur.

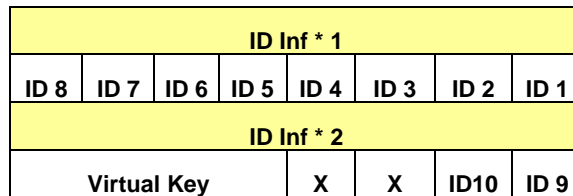

Figure 9.5.4.1

Note : ID6,ID7,ID8,ID9,ID10 Don't Care.

	Max Ponit	5 Finger			
	Total Bytes	32 Bytes			
Byte1	write_event4	Coordinate 1st	Byte23	write_event2	Finger Size 3rd
Byte2	write_event3		Byte24	write_event1	Finger Size 4th
Byte3	write_event2		Byte25	write_event4	Finger Size 5th
Byte4	write_event1		Byte26	write_event3	Dummy
Byte5	write_event4	Coordinate 2nd	Byte27	write_event2	Dummy
Byte6	write_event3		Byte28	write_event1	Dummy
Byte7	write_event2		Byte29	write_event4	Point Number
Byte8	write_event1		Byte30	write_event3	ID Inf *1
Byte9	write_event4	Coordinate 3rd	Byte31	write_event2	ID Inf *2
Byte10	write_event3		Byte32	write_event1	Checksum(LSB)
Byte12	write_event1				
Byte13	write_event4		Coordinate 4th		
Byte14	write_event3				
Byte15	write_event2				
Byte16	write_event1				
Byte17	write_event4	Coordinate 5th			
Byte18	write_event3				
Byte19	write_event2				
Byte20	write_event1				
Byte21	write_event4	Finger Size 1st			
Byte22	write_event3	Finger Size 2nd			

10. CTP COMMAND

10.1 Command list

Hex	Operation Code	D7	D6	D5	D4	D3	D2	D1	D0	Function
0	No operation	0	0	0	0	0	0	0	0	-
80	Sleep IN	1	0	0	0	0	0	0	0	-
81	Sleep Out	1	0	0	0	0	0	0	1	-
82	Sense Off	1	0	0	0	0	0	1	0	-
83	Sense On	1	0	0	0	0	0	1	1	-
85	Read Event	1	0	0	0	0	1	0	1	-
	1st parameter	B31	B30	B29	B28	B27	B26	B25	B24	-
	2nd parameter	B23	B22	B21	B20	B19	B18	B17	B16	-
	3rd parameter	B15	B14	B13	B12	B11	B10	B9	B8	-
	4th parameter	B7	B6	B5	B4	B3	B2	B1	B0	-
86	Read All Events	1	0	0	0	0	1	1	0	-
	1st parameter	B31	B30	B29	B28	B27	B26	B25	B24	-
	2nd parameter	B23	B22	B21	B20	B19	B18	B17	B16	-
	3rd parameter	B15	B14	B13	B12	B11	B10	B9	B8	-
	4th parameter	B7	B6	B5	B4	B3	B2	B1	B0	-
	5th parameter	E3	E2	E1	E0	F1	P2	P1	P0	-
	6th parameter	B23	B22	B21	B20	B19	B18	B17	B16	-
	...	:	:	:	:	:	:	:	:	-
(n+1)th parameter	B7	B6	B5	B4	B3	B2	B1	B0	-	
87	Read Latest Event	1	0	0	0	0	1	1	1	-
	1st parameter	B31	B30	B29	B28	B27	B26	B25	B24	-
	2nd parameter	B23	B22	B21	B20	B19	B18	B17	B16	-
	3rd parameter	B15	B14	B13	B12	B11	B10	B9	B8	-
	4th parameter	B7	B6	B5	B4	B3	B2	B1	B0	-
88	Clear Stack	1	0	0	0	1	0	0	0	-

10.2 User define command list table

Hex	Operation Code	D7	D6	D5	D4	D3	D2	D1	D0	Function
31h	Device ID	0	0	1	1	0	0	0	1	Response Device ID Code
	1st parameter	85								-
	2nd parameter	20								-
	3rd parameter	00								-
32h	Version ID	0	0	1	1	0	0	0	1	Read Firmware version

10.3 Command description

10.3.1 NOP

00 H	NOP (No Operation)									
	DNC	D7	D6	D5	D4	D3	D2	D1	D0	HEX
Command	0	0	0	0	0	0	0	0	0	00
Parameter	No parameter									
Description	This command is an empty command and it does not have any effect on the touch screen.									
Restriction										
Register Availability	Status					Availability				
	TS Sleep Out					Yes				
	TS Sleep In					Yes				
Default	Status					Default Value				
	Power Up Sequence					N/A				
	TS S/W Reset					N/A				
	H/W Reset					N/A				
Flow Chart										

10.3.2 TS sleep in (80h)

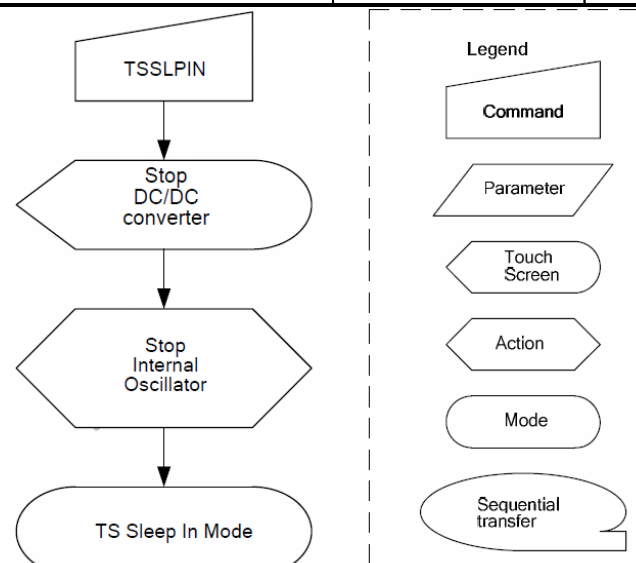
80H	TSSLPIN (Touch Screen Sleep In)									
	DNC	D7	D6	D5	D4	D3	D2	D1	D0	HEX
Command	0	1	0	0	0	0	0	0	0	80
parameter	No parameter									
Description	This command causes the touch screen to enter the minimum power consumption mode. MCU interface are register are still working and keeps their contents.									
Restriction	This command has no effect when the touch screen is already in TS Sleep In mode. TS Sleep In Mode can only be left by the TS Sleep Out Command (81h). It will be necessary to wait 5msec before sending next command. This is to allow time for the supply voltages and clock circuits to stabilize. It will be necessary to wait 5msec after sending TS Sleep Out command (when in TS Sleep In Mode) before TS Sleep In command can be sent.									
Register Availability	Status					Availability				
	TS Sleep Out					Yes				
	TS Sleep In					Yes				
Default	Status					Default Value				
	Power Up Sequence					TS Sleep In Mode				
	TS S/W Reset					TS Sleep In Mode				
	H/W Reset					TS Sleep In Mode				
Flow Chart	 <pre> graph TD A[TSSLPIN] --> B{Stop DC/DC converter} B --> C{Stop Internal Oscillator} C --> D([TS Sleep In Mode]) </pre> <p>Legend</p> <ul style="list-style-type: none"> Command Parameter Touch Screen Action Mode Sequential transfer 									

10.3.3 TS sleep out (81h)

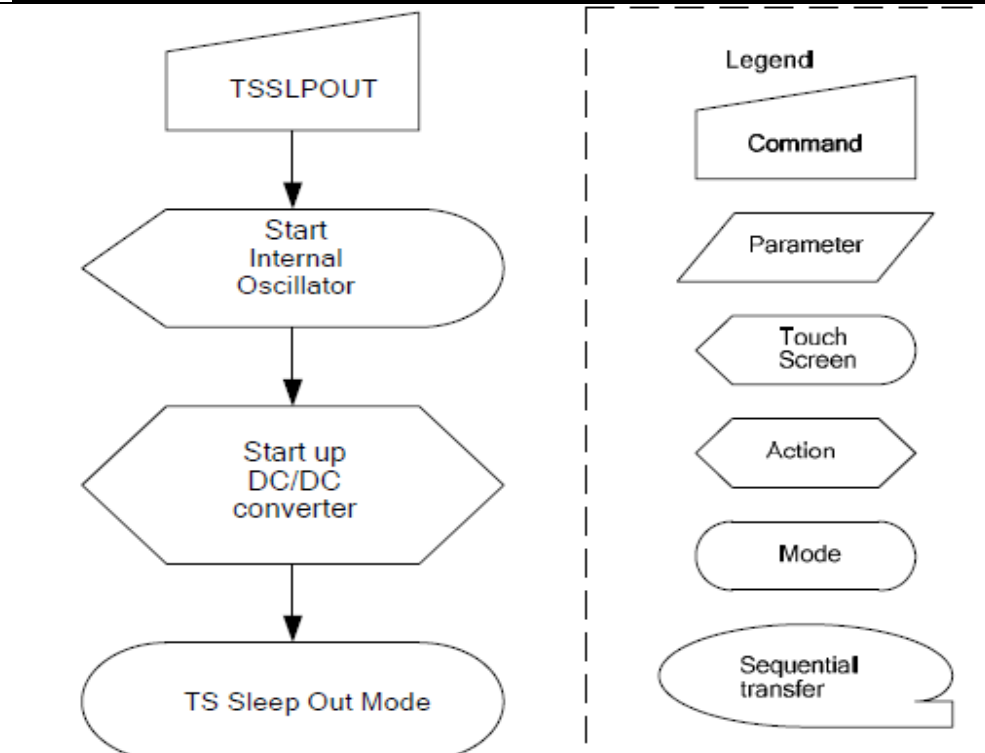
81H	TSSLPOUT (Touch Screen Sleep Out)									
	DNC	D7	D6	D5	D4	D3	D2	D1	D0	HEX
Command	0	1	0	0	0	0	0	0	1	81
parameter	No parameter									
Description	This command turns off TS Sleep In mode.									
Restriction	This command has no effect when touch screen is already in TS Sleep Out mode. TS Sleep Out Mode can only be left by the TS Sleep In Command (80h). It will be necessary to wait 5msec before sending next command. This is to allow time for the supply voltages and clock circuits to stabilize. The touch screen loads all touch screen supplier's factory default values to the registers during this 5msec and there cannot be any abnormal effect on the touch screen functionality if factory default and register values are same when this load is done and when the touch screen is already TS Sleep Out – mode. It will be necessary to wait 5msec after sending TS Sleep In command (when in TS Sleep Out mode) before TS Sleep Out command can be sent.									
Register Availability	Status					Availability				
	TS Sleep Out					Yes				
	TS Sleep In					Yes				
Default	Status					Default Value				
	Power Up Sequence					TS Sleep In Mode				
	TS S/W Reset					TS Sleep In Mode				
	H/W Reset					TS Sleep In Mode				
Flow Chart	 <pre> graph TD A[TSSLPOUT] --> B[Start Internal Oscillator] B --> C[Start up DC/DC converter] C --> D[TS Sleep Out Mode] </pre>									

10.3.4 TS sense off (82h)

82H	TSSOFF (Touch Screen Sense Off)									
	DNC	D7	D6	D5	D4	D3	D2	D1	D0	HEX
Command	0	1	0	0	0	0	0	1	0	82
parameter	No parameter									
Description	The touch screen is not sensing touches (= No new events), but the touch screen is still scanning.									
Restriction										
Register Availability	Status					Availability				
	TS Sleep Out					Yes				
	TS Sleep In					Yes				
Default	Status					Default Value				
	Power Up Sequence					TS Sense Off				
	TS S/W Reset					TS Sense Off				
	H/W Reset					TS Sense Off				
Flow Chart	<div style="border: 1px dashed black; padding: 10px;"> <p style="text-align: center;">Legend</p> <div style="display: flex; flex-direction: column; align-items: center;"> <div style="border: 1px solid black; width: 100px; height: 30px; margin-bottom: 5px;"></div> <div style="border: 1px solid black; width: 100px; height: 30px; margin-bottom: 5px; transform: rotate(-15deg);"></div> <div style="border: 1px solid black; width: 100px; height: 30px; margin-bottom: 5px; border-radius: 15px;"></div> <div style="border: 1px solid black; width: 100px; height: 30px; margin-bottom: 5px; border-top: none; border-bottom: none;"></div> <div style="border: 1px solid black; width: 100px; height: 30px; margin-bottom: 5px; border-radius: 15px;"></div> <div style="border: 1px solid black; width: 100px; height: 30px; margin-bottom: 5px; border-radius: 15px;"></div> </div> </div> <div style="display: flex; flex-direction: column; align-items: center;"> <div style="border: 1px solid black; width: 100px; height: 30px; margin-bottom: 10px;"></div> <div style="margin-bottom: 10px;">↓</div> <div style="border: 1px solid black; width: 100px; height: 30px; border-radius: 15px;"></div> </div>									

10.3.5 TS sense on (83h)

83H	TSSON (Touch Screen Sense On)									
	DNC	D7	D6	D5	D4	D3	D2	D1	D0	HEX
Command	0	1	0	0	0	0	0	1	1	83
parameter	No parameter									
Description	The touch screen is sensing touches (= No new events).									
Restriction										
Register Availability	Status					Availability				
	TS Sleep Out					Yes				
	TS Sleep In					Yes				
Default	Status					Default Value				
	Power Up Sequence					TS Sense Off				
	TS S/W Reset					TS Sense Off				
	H/W Reset					TS Sense Off				
Flow Chart	<div style="border: 1px dashed black; padding: 10px;"> <p style="text-align: center;">Legend</p> <div style="display: flex; flex-direction: column; align-items: center;"> <div style="border: 1px solid black; padding: 5px; margin-bottom: 10px;">Command</div> <div style="border: 1px solid black; padding: 5px; margin-bottom: 10px;">Parameter</div> <div style="border: 1px solid black; padding: 5px; margin-bottom: 10px;">Touch Screen</div> <div style="border: 1px solid black; padding: 5px; margin-bottom: 10px;">Action</div> <div style="border: 1px solid black; padding: 5px; margin-bottom: 10px;">Mode</div> <div style="border: 1px solid black; padding: 5px;">Sequential transfer</div> </div> </div> <div style="text-align: center;"> <div style="border: 1px solid black; padding: 5px; width: 150px; margin: 0 auto;">TSSON</div> <div style="text-align: center; margin: 5px 0;">↓</div> <div style="border: 1px solid black; padding: 5px; width: 250px; margin: 0 auto;">TS Sense On</div> </div>									

10.3.6 Read One Event (85h)

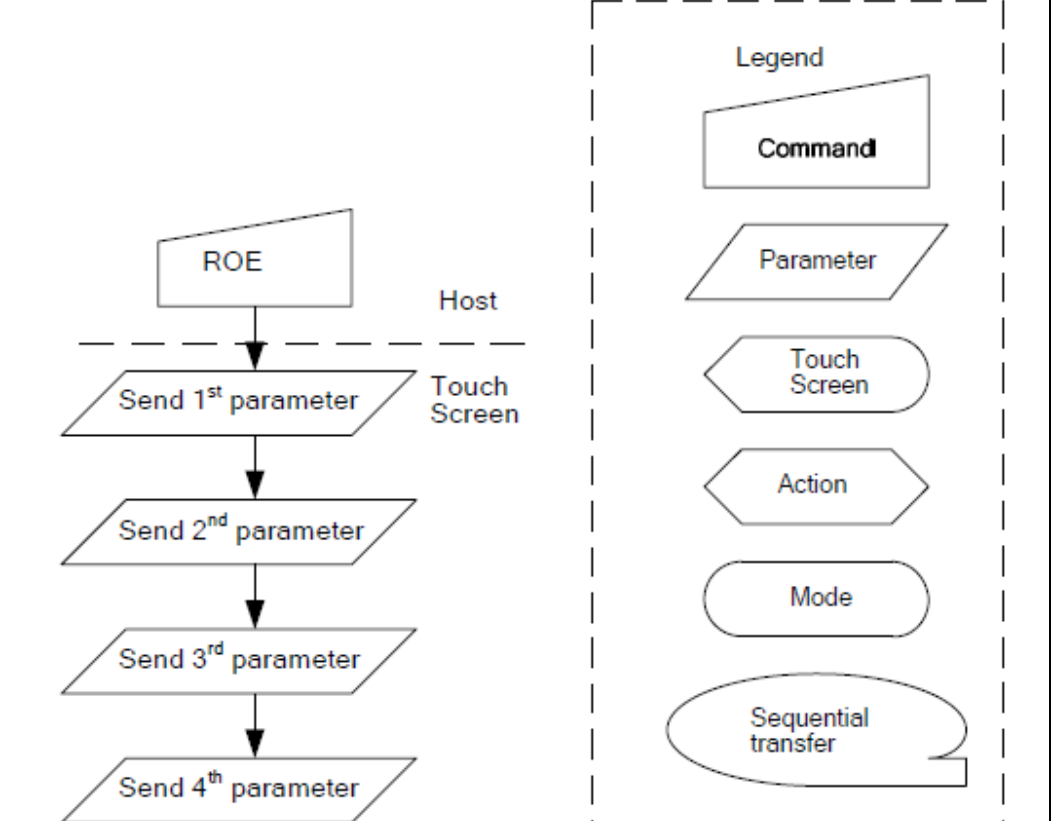
85H		ROE (Read One Event)									
		DNC	D7	D6	D5	D4	D3	D2	D1	D0	HEX
Command		0	1	0	0	0	0	1	0	1	85
1	parameter	-	B31	B30	B29	B28	B27	B26	B25	B24	xx
2	parameter	-	B23	B22	B21	B20	B19	B18	B17	B16	xx
3	parameter	-	B15	B14	B13	B12	B11	B10	B9	B8	xx
4	parameter	-	B7	B6	B5	B4	B3	B2	B1	B0	xx
Description		This command returns touch co-ordinates what is the oldest co-ordinates information what has been stored on the stock. A returning value can be "No Event" if the stock is empty. The default assignment is list as below. The assignment of event stack also can be modified if necessary (base on the requirement of customer).									
Register Availability		Status					Availability				
		TS Sleep Out					Yes				
		TS Sleep In					Yes				
Default		Status					Default Value				
		Power Up Sequence					0000 0000h				
		TS S/W Reset					0000 0000h				
		H/W Reset					0000 0000h				
Flow Chart		 <p>The flow chart illustrates the communication sequence between the Host and the Touch Screen for the Read One Event (ROE) command. The Host initiates the process by sending the ROE command. The Touch Screen then responds by sending four parameters sequentially: the 1st parameter, the 2nd parameter, the 3rd parameter, and the 4th parameter. A legend on the right side of the chart defines the symbols used: a trapezoid for Command, a parallelogram for Parameter, a hexagon for Touch Screen, a rounded hexagon for Action, a rounded rectangle for Mode, and a rounded rectangle with a tail for Sequential transfer.</p>									

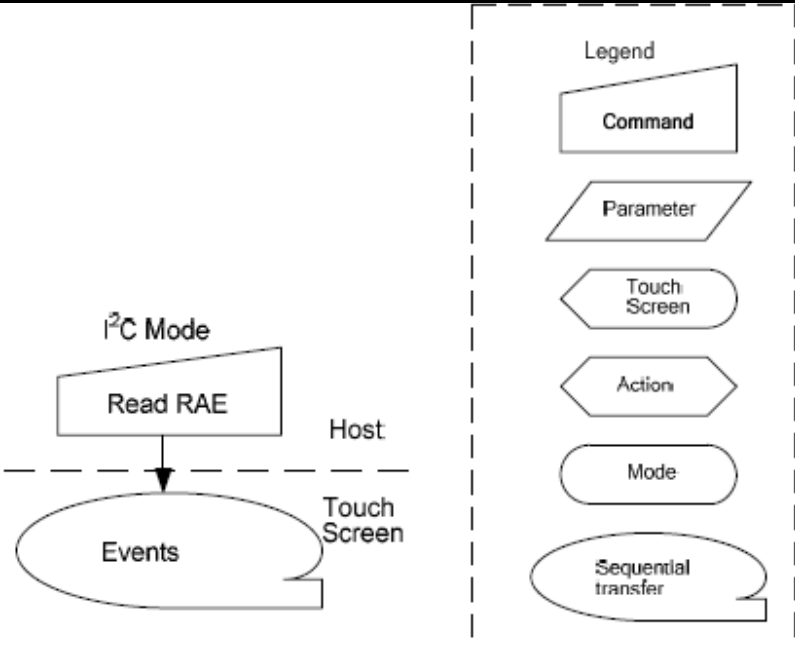

10.3.7 Read All Event (86h)

86H		RAE (Read All Events)									
		DNC	D7	D6	D5	D4	D3	D2	D1	D0	HEX
Command		0	1	0	0	0	0	1	1	0	86
1	parameter	-	B31	B30	B29	B28	B27	B26	B25	B24	xx
2	parameter	-	B23	B22	B21	B20	B19	B18	B17	B16	xx
3	parameter	-	B15	B14	B13	B12	B11	B10	B9	B8	xx
4	parameter	-	B7	B6	B5	B4	B3	B2	B1	B0	xx
5	parameter	-	E3	E2	E1	E0	F1	P2	P1	P0	xx
6	parameter	-	B23	B22	B21	B20	B19	B18	B17	B16	xx
:		-	:	:	:	:	:	:	:	:	:
(n+1) Parameter		-	B7	B6	B5	B4	B3	B2	B1	B0	xx
Description		This command returns touch co-ordinates what is the oldest co-ordinates information what has been stored on the stock. A returning value can be "No Event" if the stock is empty. The default assignment is list as below. The assignment of event stack also can be modified if necessary (base on the requirement of customer).									
Register Availability		Status			Availability						
		TS Sleep Out			Yes						
		TS Sleep In			Yes						
Default		Status			Default Value						
		Power Up Sequence			All Values 0000 0000h						
		TS S/W Reset			All Values 0000 0000h						
Flow Chart		 <p>The flow chart illustrates the process of reading RAE (Read All Events) from a Touch Screen. It starts in I²C Mode, where a Host sends a 'Read RAE' command to the Touch Screen. The Touch Screen then returns 'Events' data. A legend on the right defines the symbols used: a trapezoid for 'Command', a parallelogram for 'Parameter', a rounded rectangle for 'Touch Screen', a hexagon for 'Action', a rounded rectangle for 'Mode', and a rounded rectangle with a tail for 'Sequential transfer'.</p>									

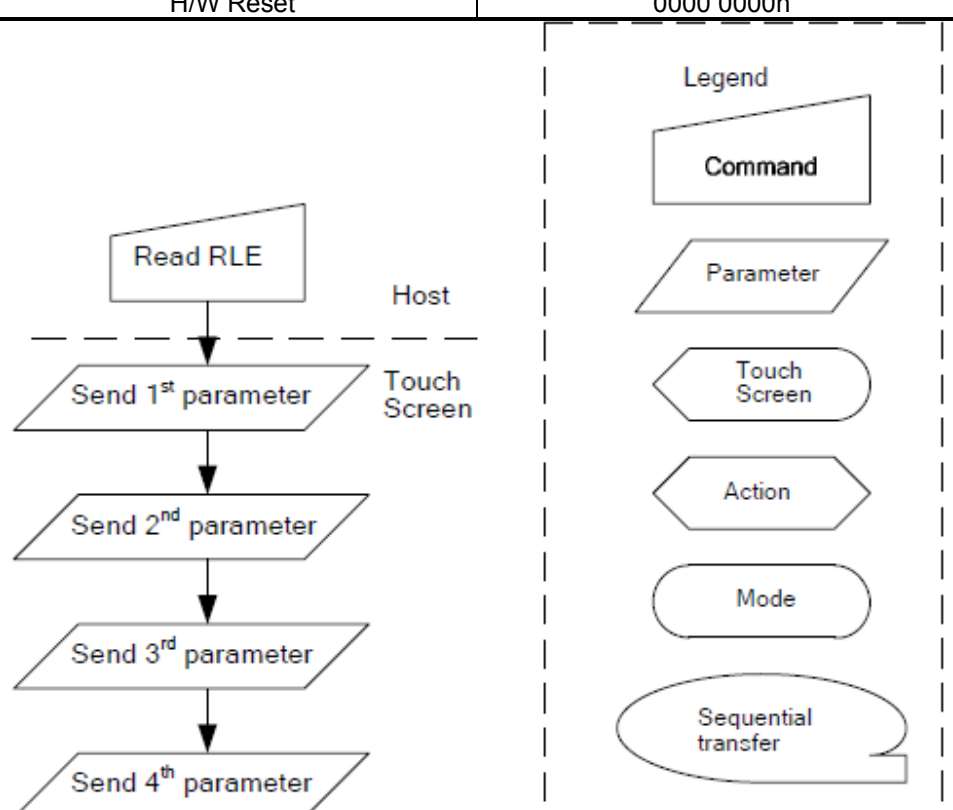
10.3.8 Read Latest Event (87h)

87H		RLE (Read Latest Event)									
		DNC	D7	D6	D5	D4	D3	D2	D1	D0	HEX
Command		0	1	0	0	0	0	1	1	1	87
1	parameter	-	B31	B30	B29	B28	B27	B26	B25	B24	xx
2	parameter	-	B23	B22	B21	B20	B19	B18	B17	B16	xx
3	parameter	-	B15	B14	B13	B12	B11	B10	B9	B8	xx
4	parameter	-	B7	B6	B5	B4	B3	B2	B1	B0	xx
Description		This command returns one touch event what is the latest co-ordinates information what has been stored on the stock. The event stack is empty after this command. A returning value can be "No Event" if the stock is empty. The default assignment is list as below. The assignment of event stack also can be modified if necessary (base on the requirement of customer).									
Register Availability		Status					Availability				
		TS Sleep Out					Yes				
		TS Sleep In					Yes				
Default		Status					Default Value				
		Power Up Sequence					0000 0000h				
		TS S/W Reset					0000 0000h				
		H/W Reset					0000 0000h				
Flow Chart											

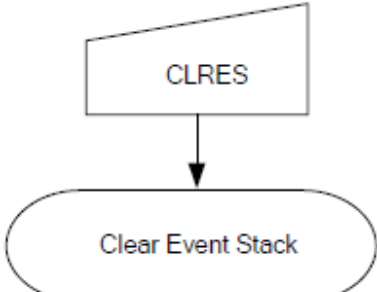
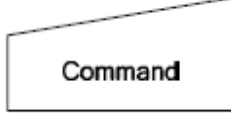
10.3.9 Clear Event Stack (88h)

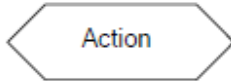
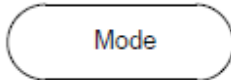
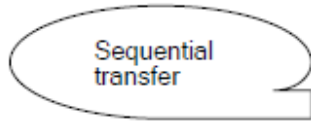
88H	CLRES (Clear Event Stack)									
	DNC	D7	D6	D5	D4	D3	D2	D1	D0	HEX
Command	0	1	0	0	0	1	0	0	0	88
parameter	No parameter									
Description	This command clears event stack when the only return event can be "No Event".									
Restriction										
Register Availability	Status					Availability				
	TS Sleep Out					Yes				
	TS Sleep In					Yes				
Default	Status					Default Value				
	Power Up Sequence					Empty Stack				
	TS S/W Reset					Empty Stack				
	H/W Reset					Empty Stack				
Flow Chart	<div style="display: flex; justify-content: space-between; align-items: flex-start;"> <div style="text-align: center;">  <pre> graph TD CLRES[CLRES] --> ClearEventStack([Clear Event Stack]) </pre> </div> <div style="border: 1px dashed black; padding: 10px;"> <p>Legend</p> <ul style="list-style-type: none">  Command  Parameter  Touch Screen  Action  Mode  Sequential transfer </div> </div>									

11. OPTICAL CHARACTERISTICS

Item	Symbol	Condition	Min.	Typ.	Max.	Unit	Remark
Response time	Tr+Tf	$\theta=0^\circ$	-	25	-	ms	Note 4
Contrast ratio	CR	At optimized viewing angle	100	400			Note 5
Viewing angle	Top	CR \geq 10	40	50	-	Deg.	Note 6
	Bottom		60	70	-		
	Left		60	70	-		
	Right		60	70	-		
Luminance of white		$\theta=0^\circ$	270	340	--	cd/m ²	Note 7,8
Uniformity			70	--		%	Note 8,9
White chromaticity	X	$\theta=0^\circ$	0.27	0.32	0.37		Note 7
	y		0.28	0.33	0.38		

Note 1: Ambient temperature =25°C. LED current $I_L= 20$ mA.

Note 2: To be measured in the dark room.

Note 3: To be measured on the center area of panel with a viewing cone of 1° by Topcon luminance meter BM-7A, after 2 minutes operation.

Note 4: Definition of response time:

The output signals of photo-detector are measured when the input signals are changed from “white” to “black”(rising time) and from “black” to “white”(falling time),respectively.

The response time is defined as the time interval between the 10% and 90% of amplitudes. Refer to figure as shown below.

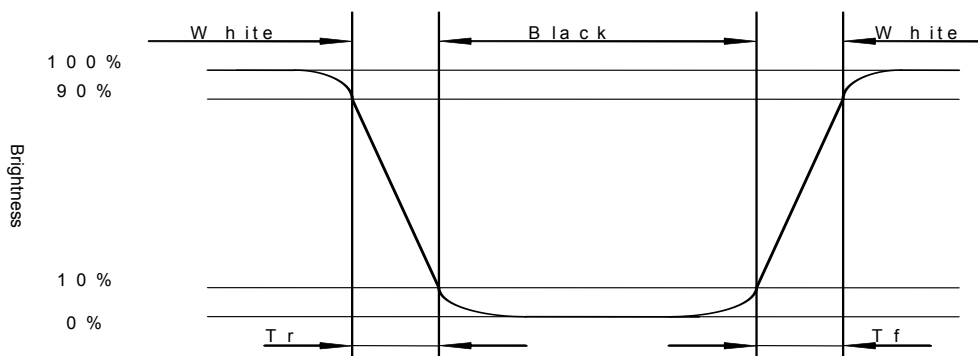

Note5: Definition of contrast ratio:

Contrast ratio is calculated with the following formula.

$$\text{Contrast ratio (CR)} = \frac{\text{Photo-detector output when LCD is at "White" state}}{\text{Photo-detector output when LCD is at "Black" state}}$$

Note 6: Definition of viewing angle:
Refer to figure as below.

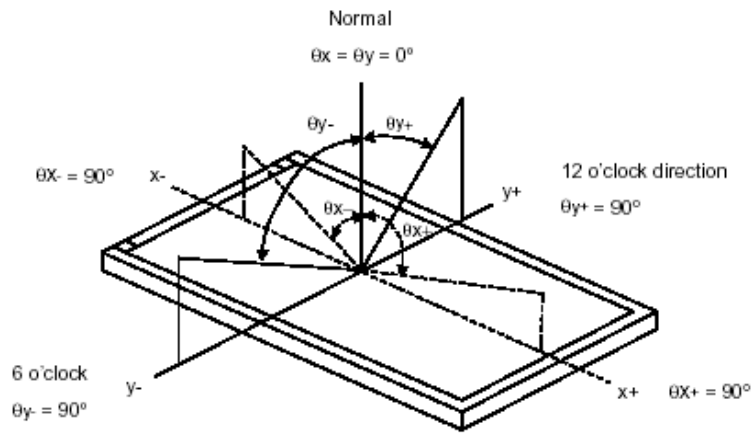

Note 7: Measured at the center area of the panel when all the input terminals of LCD panel are electrically opened.

Note 8: The method of optical measurement

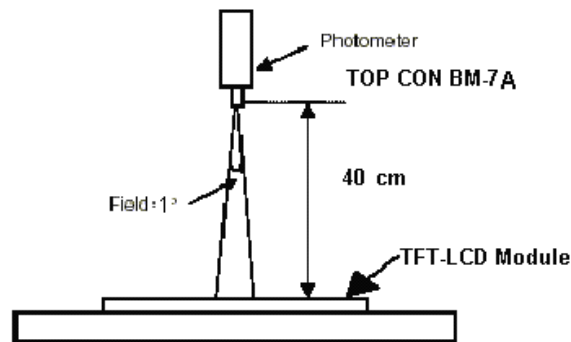

Note 9: Definition of Brightness Uniformity (B-uni):

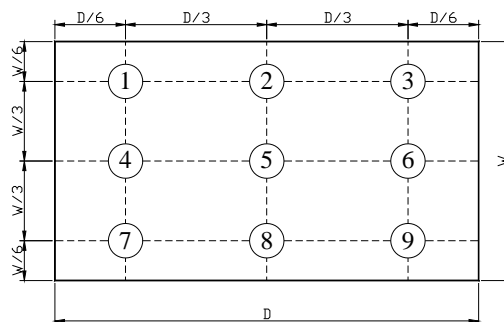

$$B\text{-uni} = \frac{\text{Minimum luminance of 9 points}}{\text{Maximum luminance of 9 points}} \quad (\text{Note 9}).$$

12. QUALITY ASSURANCE

12.1 Test Condition

12.1.1 Temperature and Humidity(Ambient Temperature)

Temperature : $25 \pm 5^{\circ}\text{C}$

Humidity : $65 \pm 5\%$

12.1.2 Operation

Unless specified otherwise, test will be conducted under function state.

12.1.3 Container

Unless specified otherwise, vibration test will be conducted to the product itself without putting it in a container.

12.1.4 Test Frequency

In case of related to deterioration such as shock test. It will be conducted only once.

12.1.5 Test Method

No.	Reliability Test Item & Level	Test Level	Remark
1	High Temperature Storage Test	T=80°C,240hrs	IEC68-2-2
2	Low Temperature Storage Test	T=-30°C,240hrs	IEC68-2-1
3	High Temperature Operation Test	T=70°C,240hrs	IEC68-2-2
4	Low Temperature Operation Test	T=-20°C,240hrs	IEC68-2-1
5	High Temperature and High Humidity Operation Test	T=60°C,90% RH,240hrs	IEC68-2-3
6	Thermal Cycling Test (No operation)	-30°C → +25°C → +80°C,200 Cycles 30 min 5min 30 min	IEC68-2-14
7	Vibration Test (No operation)	Frequency:0 ~ 55 Hz Amplitude:1.5 mm Sweep Time:11min Test Period:6 Cycles for each Direction of X,Y,Z	IEC68-2-6
8	Electrostatic Discharge Test (No operation)	150pF,330Ω Air:± 15KV;Contact: ± 8KV 10 times/point;4 points/panel face	IEC-61000-4-2

12.2 Inspection condition

12.2.1 Temperature: $25 \pm 5^\circ\text{C}$

12.2.2 Humidity: $55 \pm 10\% \text{ RH}$

12.2.3 Light source: Fluorescent Light

12.2.4 Inspection: Viewing distance: $35 \pm 5\text{cm}$

12.2.5 Ambient Illumination:

(1) Cosmetic Inspection: 400 ~ 600 lux

(2) Functional Inspection: 300 ~ 500 lux

12.2.6 Inspection View angle:

(1) Inspection under operating condition : $\pm 5^\circ$

(2) Inspection under non-operating condition : $\pm 45^\circ$

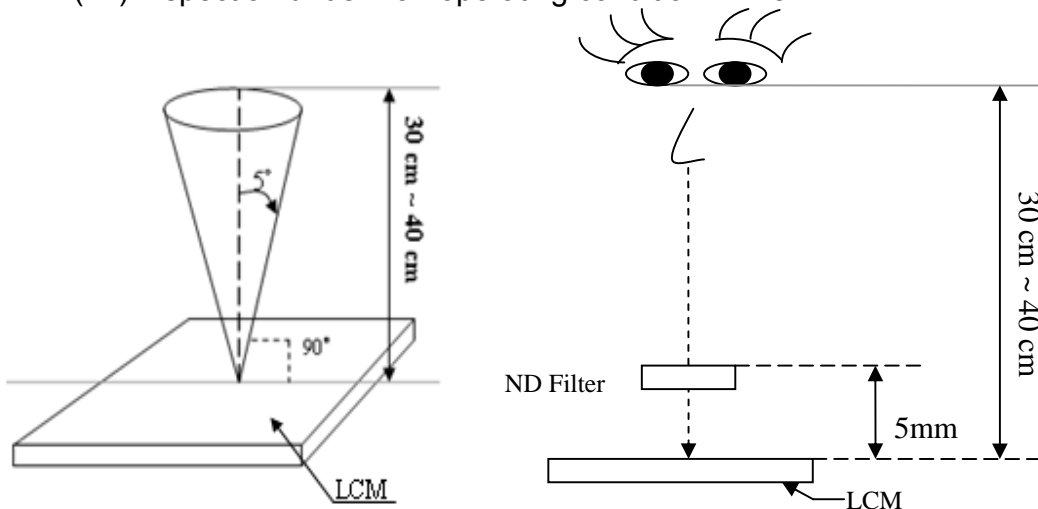

12.3 Definition of applicable Zones

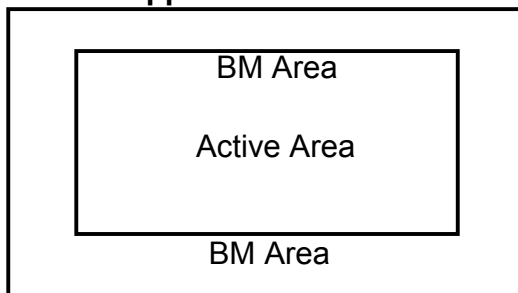

12.4 Judgment standard



The Judgment of the above test should be made after exposure in room temperature for two hours as follow:

Pass: Normal display image with no obvious non-uniformity and no line defect. Partial transformation of the module parts should be ignored.

Fail: No display image, obvious non-uniformity, or line defect.

12.5 Inspection Parameters

Appearance inspection standard (D: diameter, L: length; W: width, Z: height, T: glass thickness)

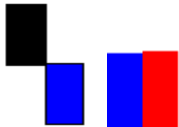
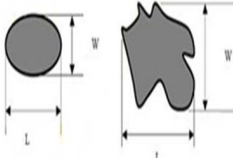
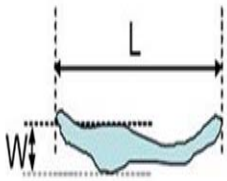
Inspection Item	Inspection Criteria	Illustration												
Display function	No Display malfunction													
Contrast ratio	Does not meet specified range in the spec.	(Major) (Note:2)												
Line Defect	No obvious Vertical and Horizontal line defect in black and White.													
Point Defect	<table border="1"> <thead> <tr> <th rowspan="2">Item</th> <th>Acceptable number</th> <th rowspan="2">Total</th> </tr> <tr> <th>Active Area</th> </tr> </thead> <tbody> <tr> <td>Bright</td> <td>2</td> <td rowspan="2">5</td> </tr> <tr> <td>Dark</td> <td>4</td> </tr> <tr> <td>Two adjacent dot</td> <td>2</td> <td>2</td> </tr> </tbody> </table>	Item	Acceptable number	Total	Active Area	Bright	2	5	Dark	4	Two adjacent dot	2	2	One Dot  Two adjacent dot 
Item	Acceptable number		Total											
	Active Area													
Bright	2	5												
Dark	4													
Two adjacent dot	2	2												
Foreign material (Black or White spots shape)	<table border="1"> <thead> <tr> <th>Zone Dimension</th> <th>Acceptable number</th> <th>Class of Defects</th> </tr> </thead> <tbody> <tr> <td>$D > 0.5 \text{ mm}$</td> <td>0</td> <td rowspan="3">Minor</td> </tr> <tr> <td>$0.3 \text{ mm} \leq D \leq 0.5 \text{ mm}$</td> <td>5</td> </tr> <tr> <td>$D < 0.3 \text{ mm}$</td> <td>*</td> </tr> </tbody> </table>	Zone Dimension	Acceptable number	Class of Defects	$D > 0.5 \text{ mm}$	0	Minor	$0.3 \text{ mm} \leq D \leq 0.5 \text{ mm}$	5	$D < 0.3 \text{ mm}$	*	 $D = (L + W) / 2$		
Zone Dimension	Acceptable number	Class of Defects												
$D > 0.5 \text{ mm}$	0	Minor												
$0.3 \text{ mm} \leq D \leq 0.5 \text{ mm}$	5													
$D < 0.3 \text{ mm}$	*													
Foreign Material (Line shape)	<table border="1"> <thead> <tr> <th>Zone Dimension</th> <th>Acceptable number</th> <th>Class of Defects</th> </tr> </thead> <tbody> <tr> <td>$W > 0.1 \text{ mm}$ or $L > 10 \text{ mm}$</td> <td>0</td> <td rowspan="3">Minor</td> </tr> <tr> <td>$0.05 \text{ mm} \leq W \leq 0.1 \text{ mm}$ $L \leq 10 \text{ mm}$</td> <td>5</td> </tr> <tr> <td>$W < 0.05 \text{ mm}$</td> <td>*</td> </tr> </tbody> </table>	Zone Dimension	Acceptable number	Class of Defects	$W > 0.1 \text{ mm}$ or $L > 10 \text{ mm}$	0	Minor	$0.05 \text{ mm} \leq W \leq 0.1 \text{ mm}$ $L \leq 10 \text{ mm}$	5	$W < 0.05 \text{ mm}$	*	 L : Long W : Width		
Zone Dimension	Acceptable number	Class of Defects												
$W > 0.1 \text{ mm}$ or $L > 10 \text{ mm}$	0	Minor												
$0.05 \text{ mm} \leq W \leq 0.1 \text{ mm}$ $L \leq 10 \text{ mm}$	5													
$W < 0.05 \text{ mm}$	*													
Non-uniformity	Visible through 5 %ND filter White, R, G, B and gray 50% pattern.	(Minor)												
Dimension	Outline	(Major)												
Bezel	uneven	(Minor)												

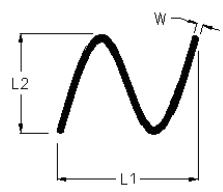
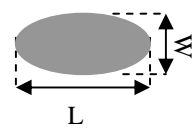
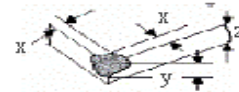
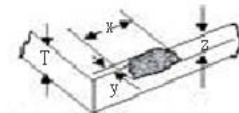
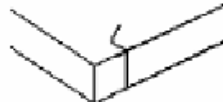
appearance												
Scratch on the Touch panel	<table border="1"> <thead> <tr> <th>Zone Dimension</th> <th>Acceptable number</th> <th>Class of Defects</th> </tr> </thead> <tbody> <tr> <td>$W > 0.1\text{mm}$ or $L > 10\text{mm}$</td> <td>0</td> <td rowspan="2">Minor</td> </tr> <tr> <td>$W \leq 0.1\text{ mm}$ $L \leq 10\text{mm}$</td> <td>5</td> </tr> </tbody> </table>	Zone Dimension	Acceptable number	Class of Defects	$W > 0.1\text{mm}$ or $L > 10\text{mm}$	0	Minor	$W \leq 0.1\text{ mm}$ $L \leq 10\text{mm}$	5			
	Zone Dimension	Acceptable number	Class of Defects									
$W > 0.1\text{mm}$ or $L > 10\text{mm}$	0	Minor										
$W \leq 0.1\text{ mm}$ $L \leq 10\text{mm}$	5											
Dent on the Touch panel	<table border="1"> <thead> <tr> <th>Zone Dimension</th> <th>Acceptable number</th> <th>Class of Defects</th> </tr> </thead> <tbody> <tr> <td>$D > 0.5\text{ mm}$</td> <td>0</td> <td rowspan="2">Minor</td> </tr> <tr> <td>$0.3\text{mm} \leq D \leq 0.5\text{ mm}$</td> <td>5</td> </tr> </tbody> </table>	Zone Dimension	Acceptable number	Class of Defects	$D > 0.5\text{ mm}$	0	Minor	$0.3\text{mm} \leq D \leq 0.5\text{ mm}$	5	 <p>$D = (L + W) / 2$</p>		
	Zone Dimension	Acceptable number	Class of Defects									
$D > 0.5\text{ mm}$	0	Minor										
$0.3\text{mm} \leq D \leq 0.5\text{ mm}$	5											
Polarizer flaw or leak out resin	Defect is defined as the active area.											
Corner Chipping	$X < 3\text{ mm}$, $Y < 3\text{ mm}$, $Z < \text{Glass thickness}$											
Edge Chipping	$X < 3\text{ mm}$, $Y < 3\text{ mm}$, $Z < \text{Glass thickness}$											
Crack	reject											

12.6 Sampling Condition

Unless otherwise agree in written, the sampling inspection shall be applied to the incoming inspection of customer.

Lot size: Quantity of shipment lot per model.

Sampling type: normal inspection, single sampling

Sampling table: MIL-STD-105E

Inspection level: Level II

Class of defects	Definition		
	Major	AQL 0.65%	It is a defect that is likely to result in failure or to reduce materially the usability of the product for the intended function.
Minor	AQL 1.5%	It is a defect that will not result in functioning problem with deviation classified.	

13. LCM PRODUCT LABEL DEFINE

Product Label style:

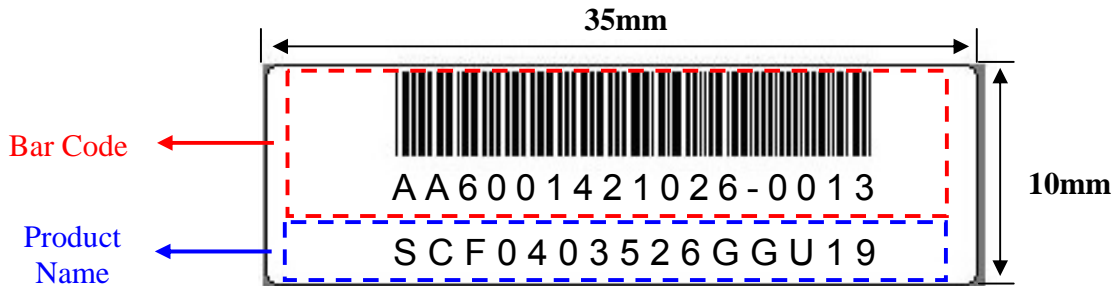

Bar Code Define:

A A 6 0014 2 10 26-0013

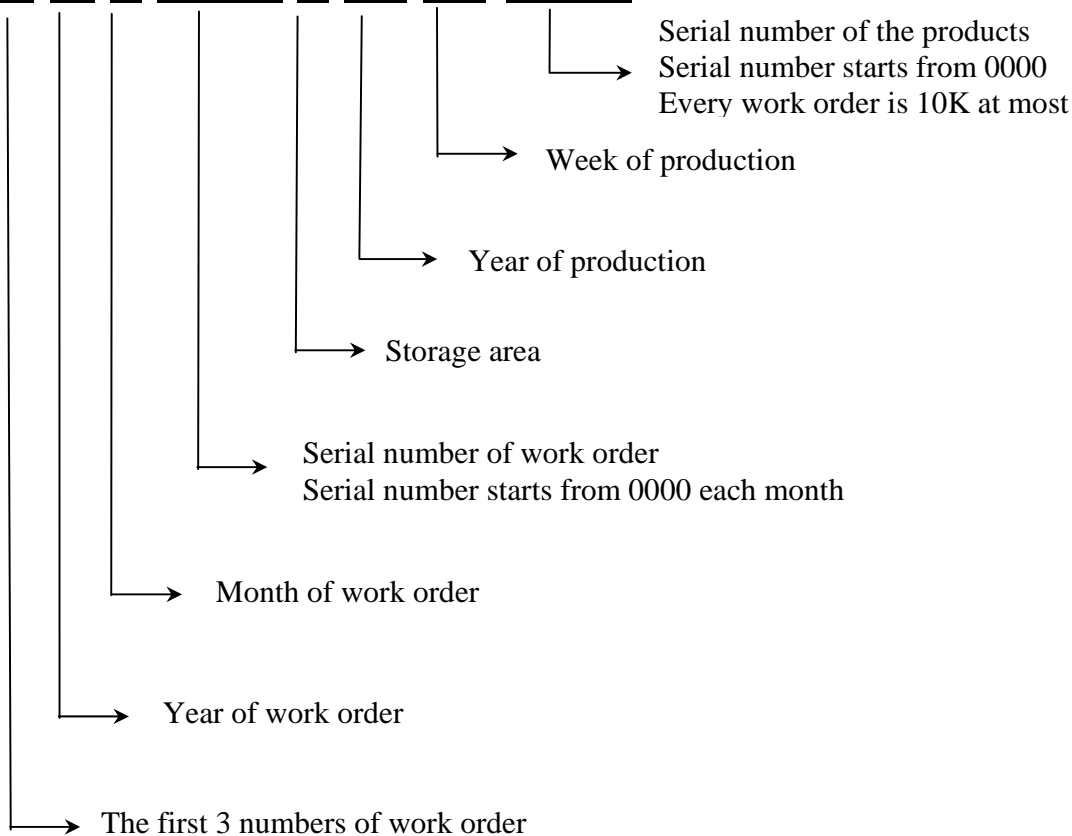

Product Name Define:

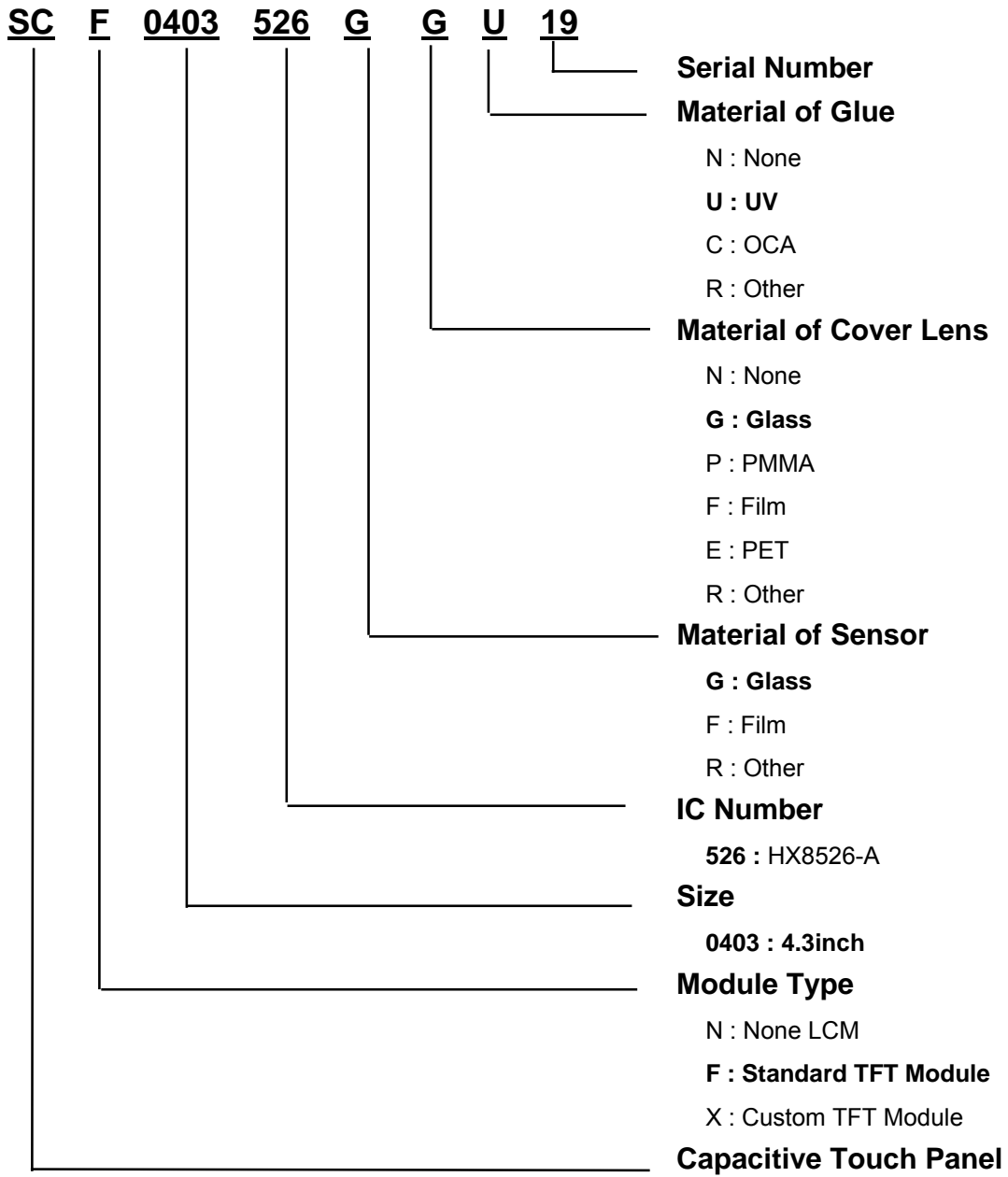

14. PRECAUTIONS IN USE LCM

1. ASSEMBLY PRECAUTIONS

- (1) Since Touch Panel is consist of glass, please be careful your hands to be injured during handing. You must wear gloves during handing.
- (2) Do not touch, push or rub the exposed touch panel, tweezers or anything harder than HB pencil lead. And please do not rub with dust clothes with chemical treatment.
- (3) Do not stack the touch panels together. Do not put heavy objects on touch panel.
- (4) Please do not take a CTP to pieces and reconstruct it. Resolving and reconstructing modules may cause them not to work well.
- (5) Please excessive force or strain to the panel or tail is prohibited, Do not lift touch panel by cable(FPC).
- (6) Use clean sacks or glove to prevent fingerprints and/or stains left on the panel. Extra attention and carefulness should be taken while handling the glass edge.
- (7) Please pay attention for the matters stated below at mounting design of touch panel enclosure. Enclosure support to fix touch panel must be out of active area.(do not design enclosure presses the active area to protect from miss put)

2. OPERATING PRECAUTIONS

- (1) Please be sure to turn off the power supply before connecting and disconnecting signal input cable.
- (2) Please do not change variable resistance settings in CTP. They are adjusted to the most suitable value. If they are changed, it might happen CTP does not satisfy the characteristics specification
- (3) Be careful for condensation at sudden temperature change. Condensation makes damage to sensor or electrical contacted parts.
- (4) CTP has high frequency circuits. Sufficient suppression to the electromagnetic interference shall be done by system manufacturers. Grounding and shielding methods may be important to minimize the interference.
- (5) Touch the panel with your finger or stylus only to assure normal operation. Any sharp edged or hard objects are prohibited.
- (6) Operate the panel in a steady environment. Abrupt variation on temperature and humidity may cause malfunction of the panel.

3. ELECTROSTATIC DISCHARGE CONTROL

- (1) The operator should be grounded whenever he/she comes into contact with the CTP. Never touch any of the conductive parts such the copper leads on the FPC and the interface terminals with any parts of the human body.

- (2) The CTP should be kept in antistatic bags or other containers resistant to static for storage.
- (3) Only properly grounded soldering irons should be used.
- (4) If an electric screwdriver is used, it should be well grounded and shielded from commentator sparks.
- (5) The normal static prevention measures should be observed for work clothes and working benches; for the latter conductive (rubber) mat is recommended
- (6) Since dry air is inductive to statics, a relative humidity of 50-60% is recommended.

5. STORAGE PRECAUTIONS

- (1) When you store touch panel for a long time, it is recommended to keep the temperature between 0°C-40°C without the exposure of sunlight and to keep the humidity less than 90%RH.
- (2) Please do not leave touch panel in the environment of high humidity and high temperature such as 60°C 90%RH
- (3) Please do not leave touch panel in the environment of low temperature; below -20°C.

6. OTHERS

For the packaging box, please pay attention to the followings:

- a. Please do not pile them up more than 5 boxes. (They are not designed so.) And please do not turn over.
- b. Please handle packaging box with care not to give them sudden shock and vibrations. And also please do not throw them up.
- c. Packing box and inner case for CTP are made of cardboard. So please pay attention not to get them wet. (Such like keeping them in high humidity or wet place can occur getting them wet.)

7. LIMITED WARRANTY

Unless otherwise agreed between DATA IMAGE and customer, DATA IMAGE will replace or repair any of its CTP which is found to be defective electrically and visually when inspected in accordance with DATA IMAGE acceptance standards, for a period on one year from date of shipment. Confirmation of such date shall be based on freight documents. The warranty liability of DATA IMAGE is limited to repair and/or replacement on the terms set forth above. DATA IMAGE will not responsible for any subsequent or consequential events.

Confidential Document
15. OUTLINE DRAWING

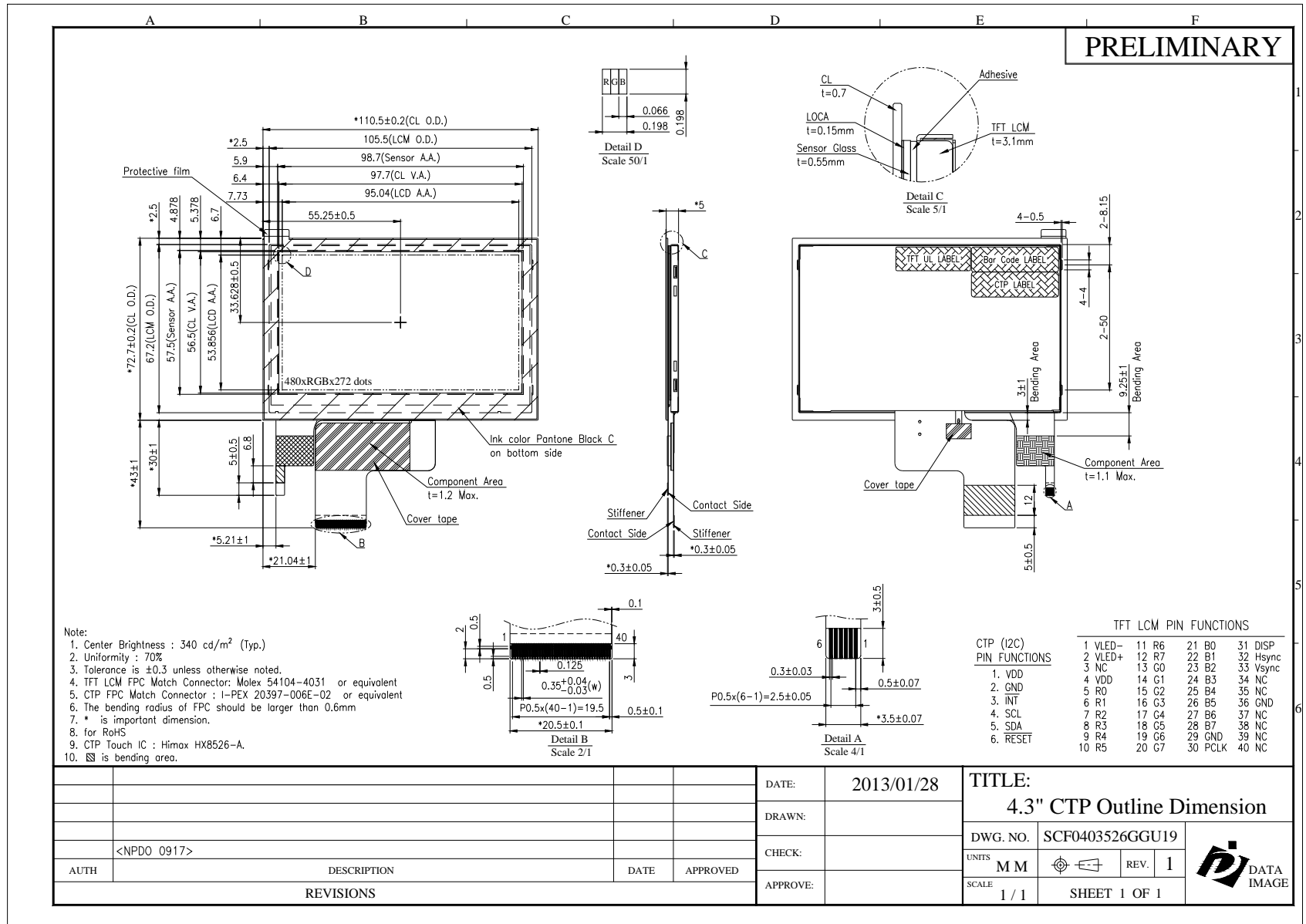

16. PACKAGE INFORMATION (TBD)