

## ***TFT-Display Datenblatt***

Modell LA060N01-SD01

### **Kurzdaten**

Hersteller	LG Display
Diagonale	6" / 15,2 cm
Format	8:3
Auflösung	720 x 272
Backlight	LED / 400 cd/m <sup>2</sup>
Interface	RGB
Touchscreen	nein
Temperatur	-30°... +85°C (Betrieb)

**Product Specifications**

## SPECIFICATION

### Model Name : LA060N01-SD01

<b>Title</b>	<b>6.0"W (720 X RGB X 272) TFT- LCD</b>
--------------	---

 Preliminary Specification

 Final Specification

<b>BUYER</b>	Hyundai Mobis
<b>SUPPLIER</b>	LG Display CO.,Ltd.



### Customer's Approval

<b>APPROVED BY</b>  _____  <b>REVIEWED BY</b>  _____	<b>DATE</b>  _____  <b>DATE</b>  _____
--	--

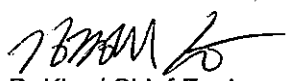
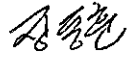
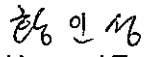
### Supplier's Approval CAS

<b>APPROVED BY</b>  J. D. Kim / Chief Engineer	<b>DATE</b>  Mar. 23. 2012
<b>REVIEWED BY</b>  D. H. Jang / Senior Engineer	Mar. 23. 2012
<b>PREPARED BY</b>  I. S. Hwang / Engineer	Mar. 23. 2012

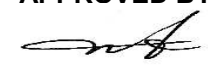
### IIS

<b>APPROVED BY</b>  H.B. Jeon/ Senior Manager	<b>DATE</b>  Mar. 23. 2012
<b>REVIEWED BY</b> M.S KANG M.S KANG/ Manager	Mar. 23. 2012
<b>PREPARED BY</b>  J.H. Cho/ Assistant	Mar. 23. 2012

**Product Specifications****Contents**

<b>NO.</b>	<b>ITEM</b>	<b>PAGE</b>
0	Record of Revisions	3
1	Summary	4
2	Features	4
3	General Specifications	5
4	Absolute Maximum Ratings	6
5	Electrical Specifications	7
6	Electro-optical Characteristics	15
7	Mechanical Characteristics	19
8	Reliability Test	22
9	International Standards	23
10	Packing	24
11	Precautions	26

**Product Specifications**
**RECORD OF REVISIONS**

Revision No.	Revision Date	Page	Description	Note
0.0	Jun.16.2011	-	First Draft (Preliminary)	
1.0	Mar.23.2012	4	Update Block diagram. - Add EEPROM	Change
		5	Update Total Power consumption 3.57 → 2.97W. - P <sub>CC</sub> : 0.93 → 0.77W - P <sub>BL</sub> : 2.64 → 2.20W Update detail surface treatment specification.	Change
		6	Correct digital RGB symbol. - R0~R4 → R1~R5, B0~B4 → B1~B5 Update notes.1 and 2	Change
		7	Correct missing pin(6) name and description. - Name: GND → TP - Description: Ground → It should be connected GND	Change
		7,8	Add notes about VBL, TP, GND, VCC, NC. Update Equivalent Circuits.	Add
		9	Update Power supply current. (Min, Typ, Max value) - I <sub>CC</sub> (Typ.): 185 → 155mA, I <sub>BL</sub> (Typ.): 528 → 440mA Correct ICC_RUSH spec. according to VCC rising time 0.5ms. - IRUSH (Max.): 0.9 → 1.5A Change Video Input Signal Voltage (Min, Max value) - V <sub>H</sub> Min: 2.7V ~ 3.3V → 0.8DVDD ~ DVDD - V <sub>L</sub> Max: 0V ~ 0.3V → 0V ~ 0.2DVDD Add Min PWM duty. Add notes 1~9.	Change, Add
		10	Change Interface timing spec due to customer only setting 18Mhz of DCLK frequency. Delete rise/fall time of interface timing spec. Add Note about DE Mode operation.	Change, Delete, Add
		11	Update digital RGB timing diagram. - Latched at the rising edge of DCLK. - Change V <sub>H</sub> , V <sub>L</sub> level.	Change
		12	Update RGB565 color input data reference	Change
		13	Change T <sub>9</sub> period due to customer request.(1500 → 1300ms) Update Power sequence Notes.	Change, Add
		14	Change 2 <sup>nd</sup> sentence of Thermistor characteristics & X-axis range of derating curve graph.(0~90℃ → 0~85℃)	
		15	Add Min Contrast Ratio Value.	Change
		16	Correct notes.7 criteria of Life time about LED Backlight.	Change
		16, 17	Correct notes.4 & Fig.4 about Response Time.	Change
		18	Correct wrong word of Fig.6 - 6.1 Typ. gamut → 6" Typ. gamut	Correct
		20, 21	Update LCM drawing due to improve ESD. - Change shape of FPC cover shield tape - Change system screw torque spec.: 4kgf → 6kgf	Change
		25	Correct 6" LCM picture and add detail packing method.	Change
		26	Correct 11-1.(7) about cleaning method & precautions for polarizer.	Change
		27	Correct 11-6.(1) about handling precautions for protection film.	Change
		-	Final specification	

## Product Specifications

### 1. Summary

This module utilizes amorphous silicon thin film transistors and a 2.65:1 aspect ratio. The 6.0" active matrix liquid crystal display allows 65,536 colors to be displayed by Digital RGB interface is available. The applications are Car Information display and Instrument Cluster for a vehicle.

### 2. Features

- Utilizes a panel with a 2.65:1 aspect ratio.
- The 6.0" screen produces a high resolution image that is composed of 195,840 pixel elements in a stripe arrangement.
- By adopting In Plane Switching (IPS) technology, provide a wide viewing angle.
- By adopting an active matrix drive, a picture with high contrast is realized.
- By using of COG mounting technology, the module became thin, light and compact.
- By adopting a high aperture panel, high transmittance color filter and high transmission polarizing plates, transmittance ratio is realized.
- Gray scale or the brightness of the sub-pixel color is determined with a RGB565 gray scale signal.

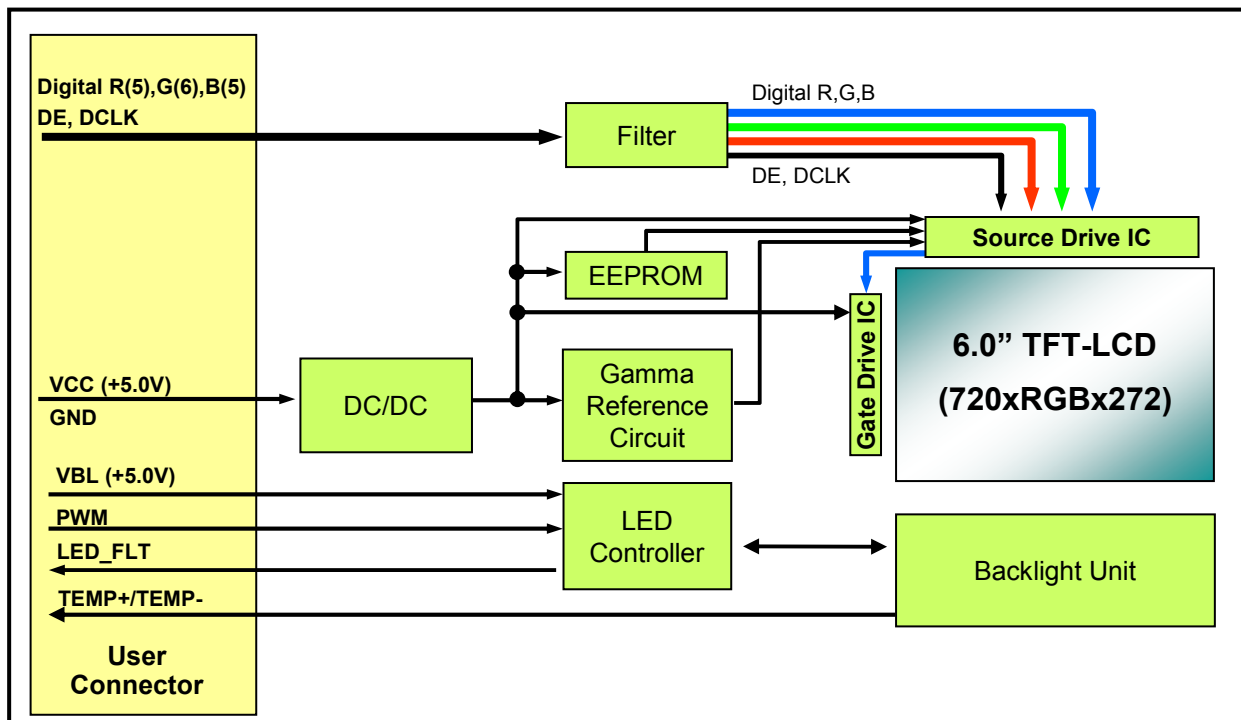

**Product Specifications**
**3. General Specification**

 @T<sub>a</sub>=25°C, Aging time: Over 10 minutes

CHARACTERISTIC ITEMS		SPECIFICATION
Input Signals	Power	DC +5.0V for logic power supply DC +5.0V for backlight
	Video	Digital RGB (RGB 565)
	Control	PWM
Active Screen Size (Diagonal)		6.0" (15.24cm), 142.56mm (H) X 53.856mm (V)
Pixel Format		720(H) X 3(R,G,B) X 272(V), RGB vertical stripes
Display Technology		a-Si TFT active matrix
		Normally Black, Transmitting mode
Outline Dimension		164.0mm (H) X 70.0mm (V) X 14.9mm (T) (Typ.)
Main Viewing Direction		Free
Pixel Pitch		0.066mm × 0.198mm
Display Modes		2.65:1
Luminance, white		400 cd/m <sup>2</sup> (Min.)
Power Consumption		P <sub>CC</sub> : 0.77 W (Typ.) @ V <sub>CC</sub> 5.0V & 25°C P <sub>BL</sub> : 2.20 W (Typ.) @ V <sub>BL</sub> 5.0V & 25°C
Weight		155g (Max.)
Backlight		LED
Surface Treatment		Hard coating(3H), Anti-Glare treatment of the front polarizer (Haze 44%)

**Product Specifications**
**4. Absolute Maximum Rating**

The followings are maximum values which, if exceeded, may cause malfunction or damage to the Module.

Parameter		Symbol	Condition	Min.	Max.	Unit	Note
Power Supply Voltage		$V_{CC}$	$T_a = 25^\circ\text{C}$	-0.3	8.0	Vdc	
		$V_{BL}$		-0.3	15.0	Vdc	
Power Supply Voltage		$I_{CC}$	$V_{CC} = 5\text{V}$	0.3	-	A	1
		$I_{BL}$	$V_{BL} = 5\text{V}$	0.8	-	A	
Input Signal	Backlight Dimming	PWM	-	-0.3	6.0	Vdc	
	Digital RGB	R1~R5 G0~G5 B1~B5 DE, CLK	-	-0.3	3.6	Vdc	
Storage Temperature		$T_{ST}$	-	-40	85	$^\circ\text{C}$	2
Operating Temperature		$T_{OP}$	-	-30	85	$^\circ\text{C}$	2,3,4

**Notes:**

- The system should supply enough current for TFT LCD module's stable operation at  $-30\sim+85^\circ\text{C}$ .
- Temperature and relative humidity range are shown in the figure below.  
Wet bulb temperature should be Max.  $58^\circ\text{C}$ . Condensation of dew must be avoided, because it may cause electrical current leakage, and deterioration of performance and quality.
- The operating temperature means that LCD Module guarantees operation of the circuit.  
All the contents of Electro-optical specifications are guaranteed under the room temperature condition.
- This temperature is ambient temperature with regard to the heat which is generated under operation of circuit and backlight on. (reference value)

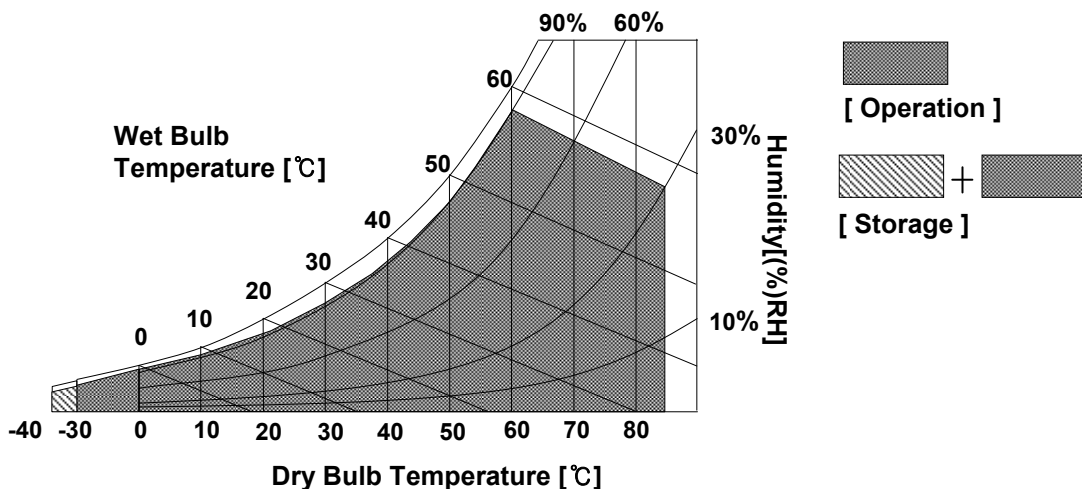

## Product Specifications

### 5. Electrical Specifications

#### 5-1. Connector pin assignment

##### 5-1-1. User Connector: CN1

The LCD module uses a 40pin connector for an interface connection.  
The model name is 9617S-40Y922 manufactured by IRISO Electronics.



Pin No.	Pin Name	I/O	Description	Notes
1	VBL	I	Power Supply For Back Light Unit	1
2	VBL	I	Power Supply For Back Light Unit	1
3	VBL	I	Power Supply For Back Light Unit	1
4	GND	I	Ground	2
5	PWM	I	LED Backlight Dimming Control Signal	
6	TP	I	Test Pin. It should be connected GND	2, 3
7	TEMP -	O	Thermal sensor output (-)	
8	TEMP +	O	Thermal sensor output (+)	
9	LED_FLT	O	LED Controller IC Fault Indicator Signal	
10	VCC	I	Power Supply For Logic	4
11	VCC	I	Power Supply For Logic	4
12	GND	I	Ground	2
13	NC	-	No Connection	5
14	B1	I	Blue Data 1 [LSB]	
15	B2	I	Blue Data 2	
16	B3	I	Blue Data 3	
17	B4	I	Blue Data 4	
18	B5	I	Blue Data 5 [MSB]	
19	GND	I	Ground	2
20	G0	I	Green Data 0 [LSB]	
21	G1	I	Green Data 1	
22	G2	I	Green Data 2	
23	G3	I	Green Data 3	
24	G4	I	Green Data 4	
25	G5	I	Green Data 5 [MSB]	
26	GND	I	Ground	2
27	NC	-	No Connection	5
28	R1	I	Red Data 1 [LSB]	
29	R2	I	Red Data 2	
30	R3	I	Red Data 3	
31	R4	I	Red Data 4	
32	R5	I	Red Data 5 [MSB]	
33	GND	I	Ground	2
34	DE	I	Digital RGB Data Enable	
35	GND	I	Ground	2
36	DCLK	I	Digital RGB Clock	
37	GND	I	Ground	2
38	NC	-	No connection	6
39	NC	-	No connection	6
40	GND	I	Ground	2



## Product Specifications

- Notes:
1. All VBL pins should be connected together.
  2. All GND pins should be connected together.
  3. This pin should be connected to GND for a normal operation.
  4. All VCC pins should be connected together.
  5. Each NC pins are connected internally with MSB data line.
  6. Make sure that NC pins should be floated.

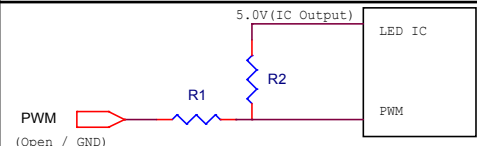
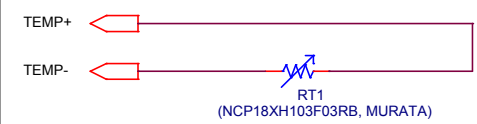
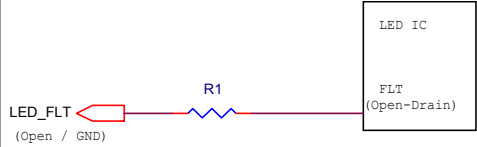
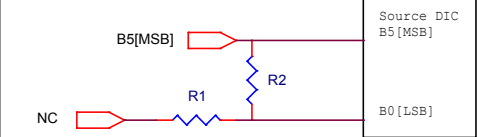
### 5-1-1-1. Equivalent Circuits (User Connector: CN1)

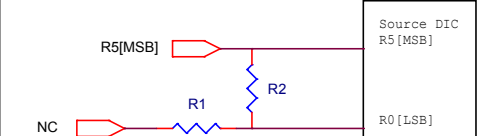
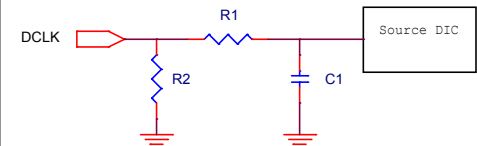
Pin No.	Pin Name	I/O	Equivalent Circuit	Value	Notes
5	PWM	I		R1: 47[Ω] R2: 10[kΩ]	
7,8	TEMP+ TEMP-	O O		RT1: 10[kΩ]	
9	LED_FLT	O		R1: 47[Ω]	1
13	NC	-		R1: open R2: 0[Ω]	
14~18 20~25 28~32 34	B1~B5 G0~G5 R1~R5 DE	I		R1: 47[Ω]	
27	NC	-		R1: open R2: 0[Ω]	
36	DCLK	I		R1: 820[Ω] R2: 47[Ω] C1: 10[pF]	

Notes:

1. LED\_FLT pin will be low (GND) when LED circuit failures occurred. (short, open, thermal shutdown).

## Product Specifications

### 5-2. Electrical Characteristics

Parameter		Symbol	Value			Unit	Note
			Min.	Typ.	Max.		
Power Supply	Video Circuit	$V_{CC}$	4.8	5.0	5.2	Vdc	
		$I_{CC}$	105	155	200	mA	1
		$I_{RUSH}$	-	-	1.5	Apeak	2
	Backlight Circuit	$V_{BL}$	4.8	5.0	5.2	Vdc	3
		$I_{BL}$	310	440	570	mA	4 PWM duty = 100%
		$I_{RUSH}$	-	-	1.2	Apeak	5 $V_{BL} = 5V$ PWM duty = 100%
Video Input Signal Voltage	Digital RGB	$V_H$	0.8DVDD	-	DVDD	V	6
		$V_L$	0	-	0.2DVDD	V	
Control Signal	PWM	$f_{DIM}$	16	-	20	kHz	7,8
		$V_{PWM\_HIGH}$	2.7	-	3.3	-	7
		$V_{PWM\_LOW}$	0	-	0.3	V	
		Duty	10	-	100	%	On Duty Ratio
Output Signal	LED_FLT	$V_H$	Open Drain			-	
		$V_L$	0	-	0.7	V	

Note 1. The specified current and power consumption are under the  $V_{CC}=5.0V$ ,  $T_a=25^\circ C$ ,  $f_{VP}=60Hz$  condition whereas white pattern is displayed and  $f_{VP}$  is the frame frequency.

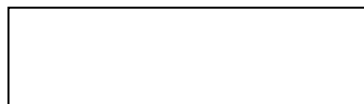

**Full White Pattern**

2. The duration of rush current is about 2ms and rising time of power input is 0.5ms (min.).  
( $V_{CC}=5.0V$ ,  $T_a=25^\circ C$ ,  $f_{VP}=60Hz$ )
3. Electrical characteristics are determined after the unit has been 'ON' and stable for approximately 10 minutes at  $25^\circ C$ .
4. The permissible forward current of LED vary with environmental temperature.
5. The duration of rush current is about 10ms and rising time of power input is 0.5ms (min.).  
( $V_{BL}=5.0V$ ,  $T_a=25^\circ C$ , PWM\_duty=100%)
6. DVDD means internal logic power voltage. (typ. 3.3V)
7. The PWM is internally pulled up to High.
8. DC current dimming is recommended for LED control. If PWM dimming is needed, PWM frequency should be optimized for minimal wavy and audible noise.
9. The recommended operating conditions show the ranges in which the device can operate normally. Operation beyond the limit of the recommended operation conditions is not assured, even though operating conditions are within the limit of the maximum ratings.

## Product Specifications

### 5-3. Interface Timing Specification (Digital RGB)

This is the signal timing required at the input of the User connector. All of the interface signal timing should be satisfied with the following specifications for its proper operation.

**Table 5-1. SIGNAL TIMING CHARACTERISTICS ( $f_{VP}=60\text{Hz}$ )**

Parameter		Symbol	Min	Typ	Max	Unit	Note
DCLK	Frequency	$f_{CLK}$	17.5	18.0	18.5	MHz	Fig.1
	Width_High	$t_{WCH}$	10	-	-	ns	
	Width_Low	$t_{WCL}$	10	-	-		
	cycle time	$t_{CTCD}$	23	-	-		
Vertical	Frequency	$f_{VP}$	60	60	60	Hz	
DE	Horizontal Valid	$t_{WHA}$	720	720	720	$t_{CLK}$	
	Horizontal Period	$t_{HP}$	995	1020	1045		
	Vertical Valid	$t_{WVA}$	272	272	272	$t_{Hp}$	
	Vertical Period	$t_{VP}$	293	294	295		
DE, DATA	Setup Time	$t_S$	10	-	-	ns	
	Hold Time	$t_H$	5	-	-		

Note 1. DE only mode operation.

2. The performance of the electro-optical characteristics may be influenced by variance of the vertical refresh rates.

Product Specifications

Fig. 1 Digital RGB Timing Diagram

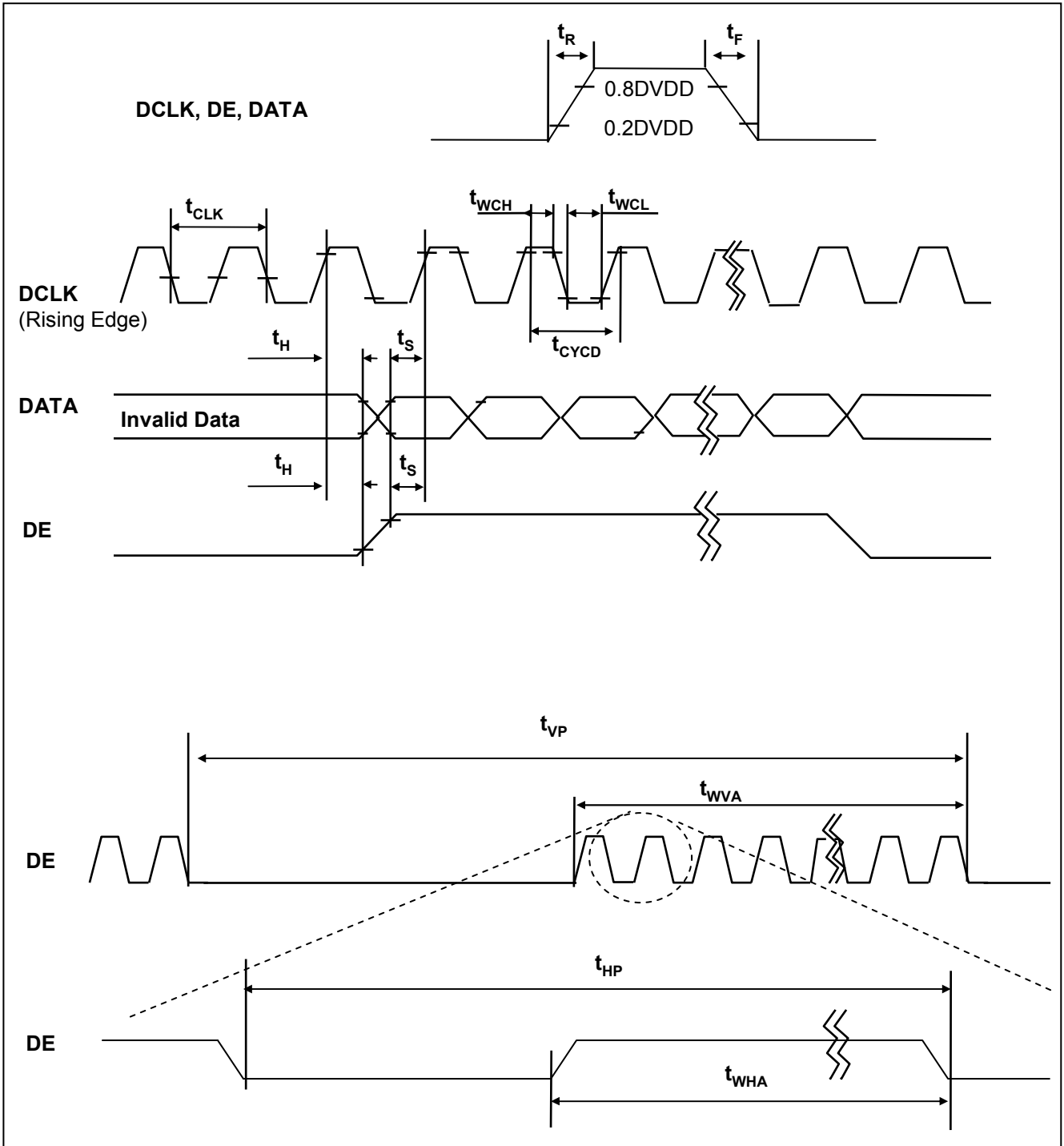

Notes: DVDD means internal logic power voltage. (typ. 3.3V)

## Product Specifications

### 5-3-2. Color Input Data Reference(Digital RGB)

The brightness of each primary color(red,green and blue) is based on the 16bit(RGB 565) data input for the color ; the higher the binary input, the brighter the color.

The following table provides a reference for color versus data input.

#### COLOR DATA REFERENCE

Color		Input Color Data																	
		Red						Green						Blue					
		MSB		LSB				MSB		LSB				MSB		LSB			
		R5	R4	R3	R2	R1	R0	G5	G4	G3	G2	G1	G0	B5	B4	B3	B2	B1	B0
Basic Colors	Black(00)	0	0	0	0	0	0	0	0	0	0	0	0	0	0	0	0	0	0
	Red(63)	1	1	1	1	1	1	0	0	0	0	0	0	0	0	0	0	0	0
	Green(63)	0	0	0	0	0	0	1	1	1	1	1	1	0	0	0	0	0	0
	Blue(63)	0	0	0	0	0	0	0	0	0	0	0	0	1	1	1	1	1	1
	Cyan(63)	0	0	0	0	0	0	1	1	1	1	1	1	1	1	1	1	1	1
	Magenta(63)	1	1	1	1	1	1	0	0	0	0	0	0	1	1	1	1	1	1
	Yellow(63)	1	1	1	1	1	1	1	1	1	1	1	1	0	0	0	0	0	0
	White(63)	1	1	1	1	1	1	1	1	1	1	1	1	1	1	1	1	1	1
Red	Red(00) Dark	0	0	0	0	0	0	0	0	0	0	0	0	0	0	0	0	0	0
	Red(00)	0	0	0	0	0	0	0	0	0	0	0	0	0	0	0	0	0	0
	Red(02)	0	0	0	0	1	0	0	0	0	0	0	0	0	0	0	0	0	0
	:	:	:	:	:	:	:	:	:	:	:	:	:	:	:	:	:	:	:
	Red(61)	1	1	1	1	0	1	0	0	0	0	0	0	0	0	0	0	0	0
	Red(63)	1	1	1	1	1	1	0	0	0	0	0	0	0	0	0	0	0	0
	Red(63) Bright	1	1	1	1	1	1	0	0	0	0	0	0	0	0	0	0	0	0
Green	Green(00)Dark	0	0	0	0	0	0	0	0	0	0	0	0	0	0	0	0	0	0
	Green(01)	0	0	0	0	0	0	0	0	0	0	1	0	0	0	0	0	0	0
	Green(02)	0	0	0	0	0	0	0	0	0	0	1	0	0	0	0	0	0	0
	:	:	:	:	:	:	:	:	:	:	:	:	:	:	:	:	:	:	:
	Green(61)	0	0	0	0	0	0	1	1	1	1	0	1	0	0	0	0	0	0
	Green(62)	0	0	0	0	0	0	1	1	1	1	1	0	0	0	0	0	0	0
	Green(63)Bright	0	0	0	0	0	0	1	1	1	1	1	1	0	0	0	0	0	0
Blue	Blue(00) Dark	0	0	0	0	0	0	0	0	0	0	0	0	0	0	0	0	0	0
	Blue(00)	0	0	0	0	0	0	0	0	0	0	0	0	0	0	0	0	0	0
	Blue(02)	0	0	0	0	0	0	0	0	0	0	0	0	0	0	0	0	1	0
	:	:	:	:	:	:	:	:	:	:	:	:	:	:	:	:	:	:	:
	Blue(61)	0	0	0	0	0	0	0	0	0	0	0	1	1	1	1	1	0	1
	Blue(63)	0	0	0	0	0	0	0	0	0	0	0	1	1	1	1	1	1	1
	Blue(63) Bright	0	0	0	0	0	0	0	0	0	0	0	1	1	1	1	1	1	1

Note: Each Red and Blue LSB(R0, B0) data lines are connected internally with MSB data line.

**Product Specifications**
**5-4. Power Supply Sequence**

For LCD's normal operation, it should be kept below power supply sequence.

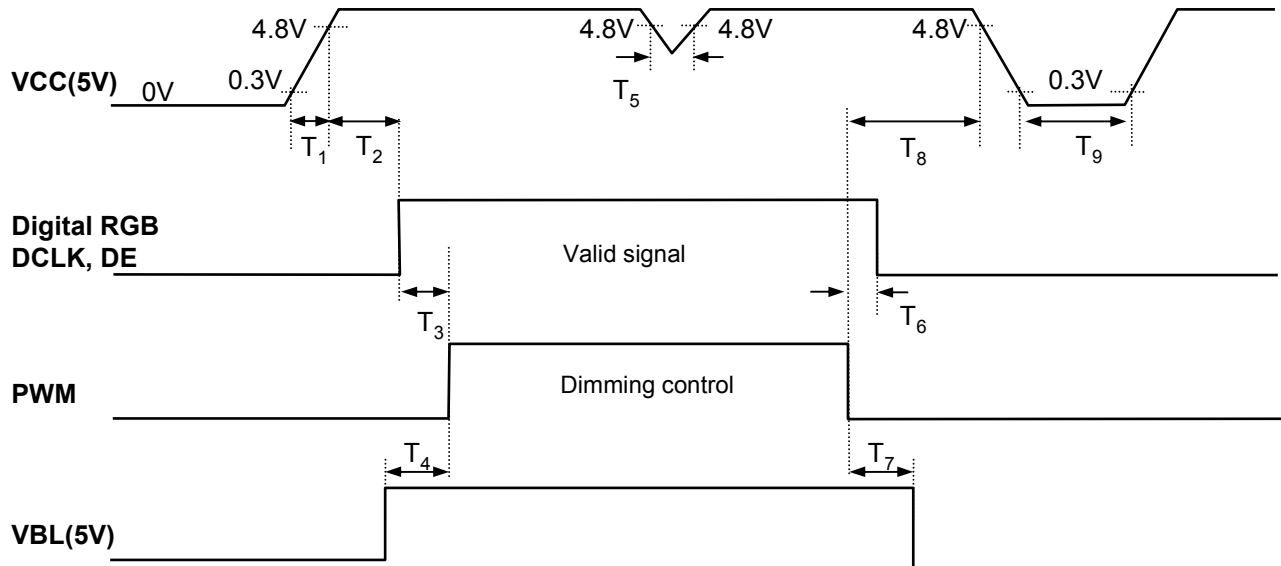

Parameter	Value			Units	Note
	Min.	Typ.	Max.		
T <sub>1</sub>	0	-	10	(ms)	
T <sub>2</sub>	100	-	1000	(ms)	
T <sub>3</sub>	800	-	-	(ms)	
T <sub>4</sub>	500	-	-	(ms)	
T <sub>5</sub>	0	-	100	(us)	1
T <sub>6</sub>	0	-	-	(ms)	
T <sub>7</sub>	0	-	-	(ms)	
T <sub>8</sub>	0	-	100	(ms)	
T <sub>9</sub>	1300	-	-	(ms)	

Note 1. Power deep time. If it is longer than the T<sub>5</sub> maximum value, LCD would be abnormal state.

In this case, you must re-initialize the LCD in accordance with "Power Supply Sequence".

2. Please avoid floating state of interface signal at invalid period.
3. When the interface signal is invalid, be sure to pull down the power supply for LCD VCC to 0V.
4. Backlight must be turn on after power supply for LCD and interface signal are valid.  
PWM must be kept GND before dimming control to avoid abnormal display, because PWM is internally pulled-up to high.
5. If it is difficult to perform as our recommendation, customers are asked to confirm the Power sequence with LG Display prior to their use.

**Product Specifications**
**5-5. Thermistor Characteristics**

The display module shall incorporate a NTC thermistor surface mounted to LCM  
 It is highly recommended that the de-rating technology which is described below be applied to the LCM for safety reasons.

For example, the user can measure display temperature from the thermistor and then turn off backlight when LCD module temperature exceeds maximum rating.

@PWM=100%

℃ (Ta)	$R_{\text{thermistor}}$ [kΩ] (Thermistor)	$R_{\text{THER}}$ [kΩ] (LCM)
-30	113.35	(71.88) ± 5%
-25	87.56	(56.67) ± 5%
-20	68.23	(44.70) ± 5%
-15	53.65	(35.58) ± 5%
-10	42.51	(28.51) ± 5%
-5	33.89	(23.14) ± 5%
0	27.22	(18.75) ± 5%
5	22.02	(15.34) ± 5%
10	17.93	(12.57) ± 5%
15	14.67	(10.40) ± 5%
20	12.08	(8.62) ± 5%
25	10 ± 1%	(7.21) ± 5%
30	8.32	(6.05) ± 5%
35	6.95	(5.09) ± 5%
40	5.83	(4.30) ± 5%
45	4.92	(3.71) ± 5%
50	4.16	(3.12) ± 5%
55	3.54	(2.68) ± 5%
60	3.01	(2.30) ± 5%
65	2.59	(1.99) ± 5%
70	2.23	(1.73) ± 5%
75	1.93	(1.51) ± 5%
80	1.67	(1.32) ± 5%
85	1.45	(1.16) ± 5%

**NCP18XH103F0SRB characteristics**

\*  $R_{\text{thermistor}}$  in the table is the feature of the thermistor by itself, and  $R_{\text{THER}}$  is measured value in the LCM.  
 Customers should refer to the value of  $R_{\text{THER}}$  for LED derating.  
 Maximum PWM duty ratio needs to be controlled following below graph for backlight life time.

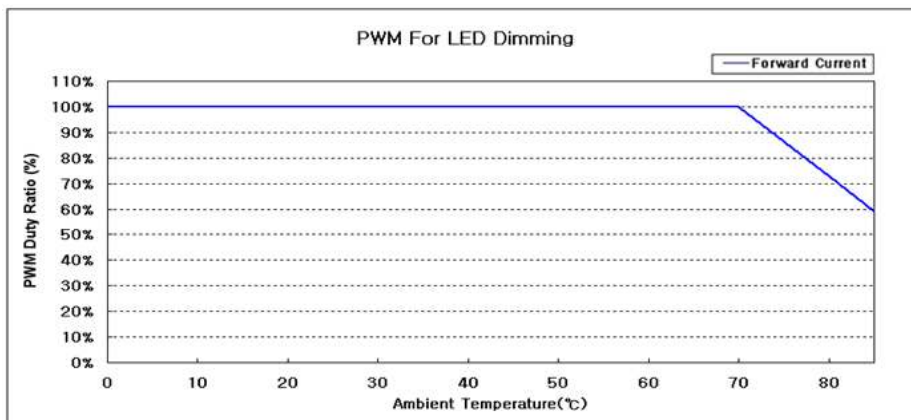

## Product Specifications

### 6. Electro-optical Characteristics

@T<sub>a</sub>=25°C, Aging time: Over 10 minutes

Parameter		Symbol	Value			Unit	Note
			Min.	Typ.	Max.		
Contrast Ratio		CR	560	800	-	-	1
Surface Luminance, white		L <sub>WH</sub>	400	-	-	cd/m <sup>2</sup>	2
Luminance Non Uniformity		LNU <sub>W</sub>	-	-	15	%	3
Response Time	Rise Time	Tr <sub>R</sub>	-	15	17	ms	4
	Decay Time	Tr <sub>D</sub>	-	10	13	ms	
Color Coordinates	Red	R <sub>X</sub>	0.605	0.635	0.665	-	2 (Reference Value)
		R <sub>Y</sub>	0.320	0.350	0.380		
	Green	G <sub>X</sub>	0.306	0.336	0.366		
		G <sub>Y</sub>	0.573	0.603	0.633		
	Blue	B <sub>X</sub>	0.118	0.148	0.178		
		B <sub>Y</sub>	0.71	0.101	0.131		
White	W <sub>X</sub>	0.281	0.311	0.341	-	2	
	W <sub>Y</sub>	0.308	0.338	0.368			
Color Gamut			-	60	-	%	5
Viewing Angle	x axis, right(φ=0°)	Θ <sub>r</sub>	-	89	-	degree	6
	x axis, left (φ=180°)	Θ <sub>l</sub>	-	89	-		
	y axis, up (φ=90°)	Θ <sub>u</sub>	-	89	-		
	y axis, down (φ=270°)	Θ <sub>d</sub>	-	89	-		
Life Time		-	20,000	-	-	Hours	7

Notes:

- Contrast Ratio (CR) is defined mathematically as

$$\text{Contrast Ratio} = \frac{\text{Surface Luminance with all white pixels}}{\text{Surface Luminance with all black pixels}}$$

- Surface luminance is measured at the center point(L1) of the LCD with all pixels displaying white at the distance of 50cm by PR-880. Color Coordinates are measured at the center point(L1) of the LCD with all pixels displaying red, green, blue and white at the distance of 50cm by PR-650. For more information, refer to the Fig. 2 and Fig. 3.
- The variation in surface luminance. The panel total variation (LNU<sub>W</sub>) is determined by measuring LN at each test position 1 through 9. For more information see Fig. 3.

$$\delta_{\text{WHITE}} = [\text{Maximum}(L1, L2, \dots, L9) - \text{Minimum}(L1, L2, \dots, L9)] / \text{Average}(L1, L2, \dots, L9) \times 100$$



**Product Specifications**

Notes :

4. Response time is the time required for the display to transition from black to white (Rise Time,  $Tr_R$ ) and from white to black (Decay Time,  $Tr_D$ ). For additional information see Fig. 4.
5. Color Gamut is measured at the center point(L1) of the LCD with all pixels displaying R,G,B at the distance of 50cm by PR-650. Color Coordinates are measured at the center point(L1) of the LCD with all pixels displaying R,G,B and white at the distance of 50cm by PR-650. For more information, refer to the Fig. 2 and Fig. 6.

$$\text{Color Gamut} = \frac{\text{Color Area with R,G,B Color Coordinates}}{\text{NTSC Standard Area at CIE 1931 Color Coordinator}}$$

6. Viewing angle is the angle at which the contrast ratio is greater than 10. The angles are determined for the horizontal or x axis and the vertical or y axis with respect to the z axis which is normal to the LCD surface. For more information see Fig. 5.
7. The life time is determined as the time at which brightness of LED is 50% compare to that of initial value at the typical LED current.

**Fig. 2 Optical Characteristic Measurement Equipment and Method**

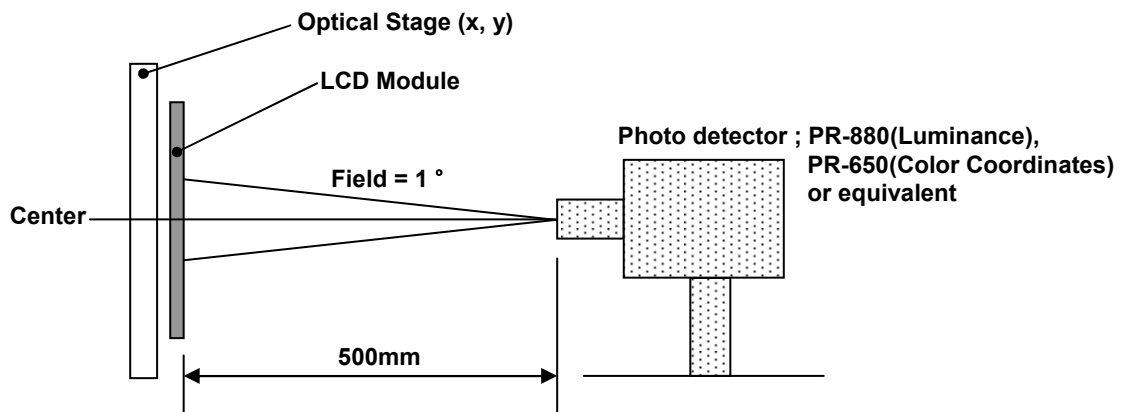

- Measuring Conditions ;
- Surroundings : Dark Room
  - Temperature :  $T_a=25^\circ\text{C}$
  - Input Video Signal : Digital RGB (RGB 565)
  - Electrical parameters set typical values.
  - Measured value at the center point of LCD panel after more than 10 minutes while backlight turning on.

Product Specifications

Fig. 3 Non-Uniformity

<measuring point for surface luminance & measuring point for luminance variation >

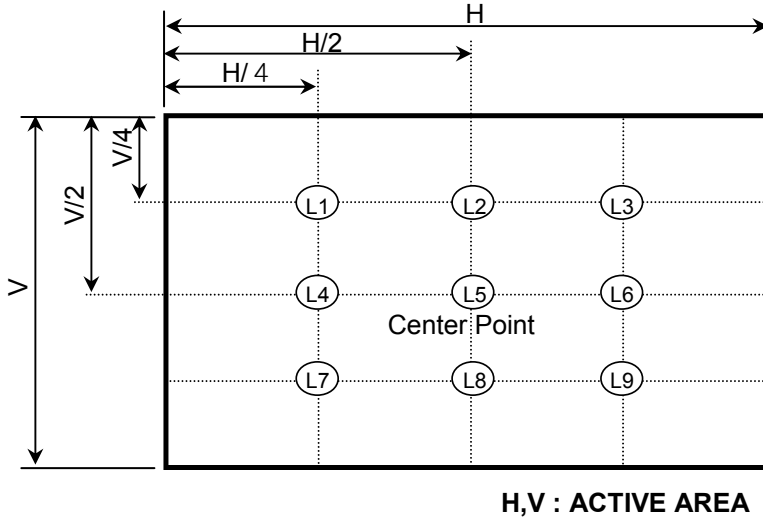

Fig. 4 Response Time

The response time is defined as the following figure and shall be measured by switching the input signal for "black" and "white".

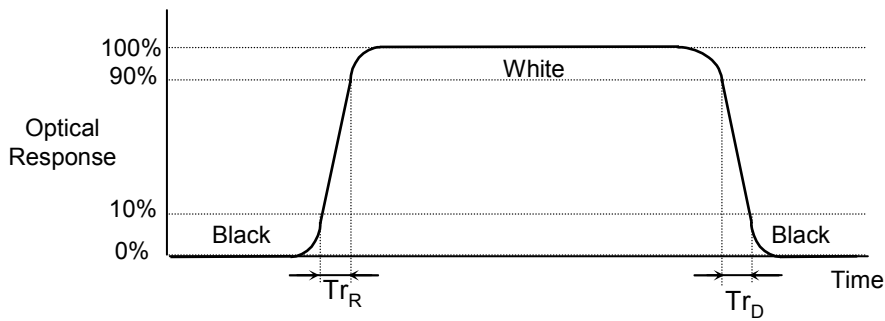
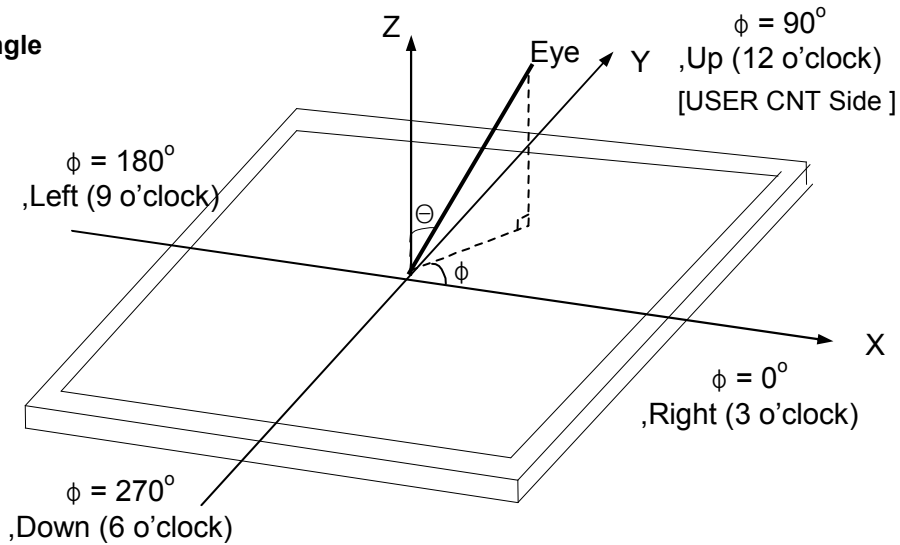
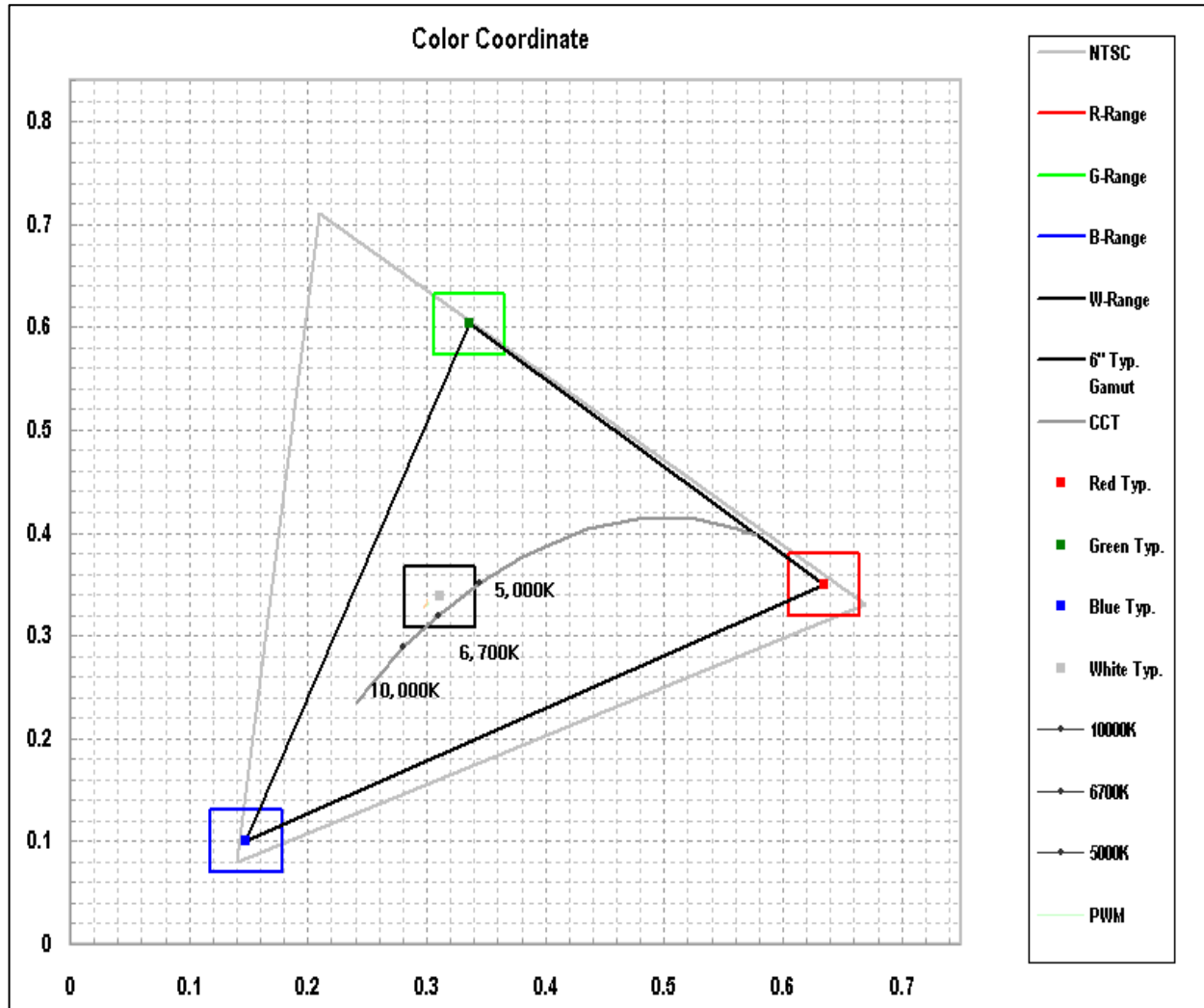

Fig. 5 Viewing angle



Product Specifications

Fig. 6 Color Coordinator



## Product Specifications

### **7. Mechanical Characteristics**

The contents provide general mechanical characteristics for this module. In addition the figures in the next page are detailed mechanical drawing of the LCD.

Outline Dimension	Horizontal	164.0 ( $\pm 0.3$ )mm
	Vertical	70.5 ( $\pm 0.3$ )mm
	Thickness	14.9 ( $\pm 0.3$ )mm
Bezel Area	Horizontal	145.6 ( $\pm 0.2$ )mm
	Vertical	56.9( $\pm 0.2$ )mm
Active Display Area	Horizontal	142.56 mm
	Vertical	53.86 mm
Weight	155g (Max.)	

**Product Specifications**

<FRONT VIEW>

Note) Unit:[mm], General tolerance: ± 0.3mm

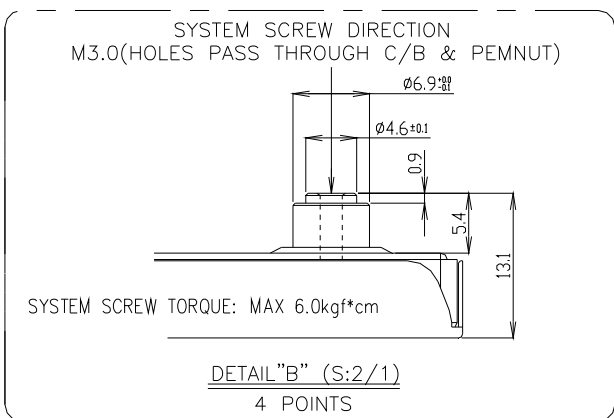
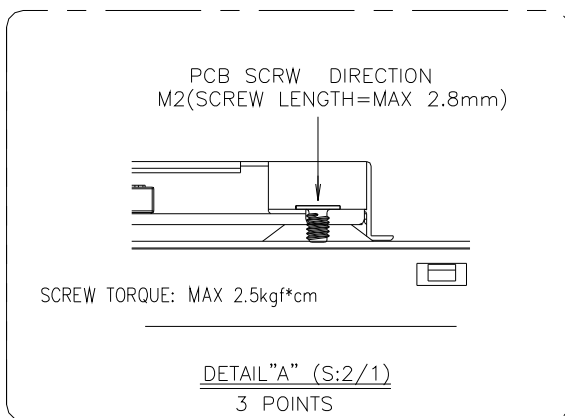
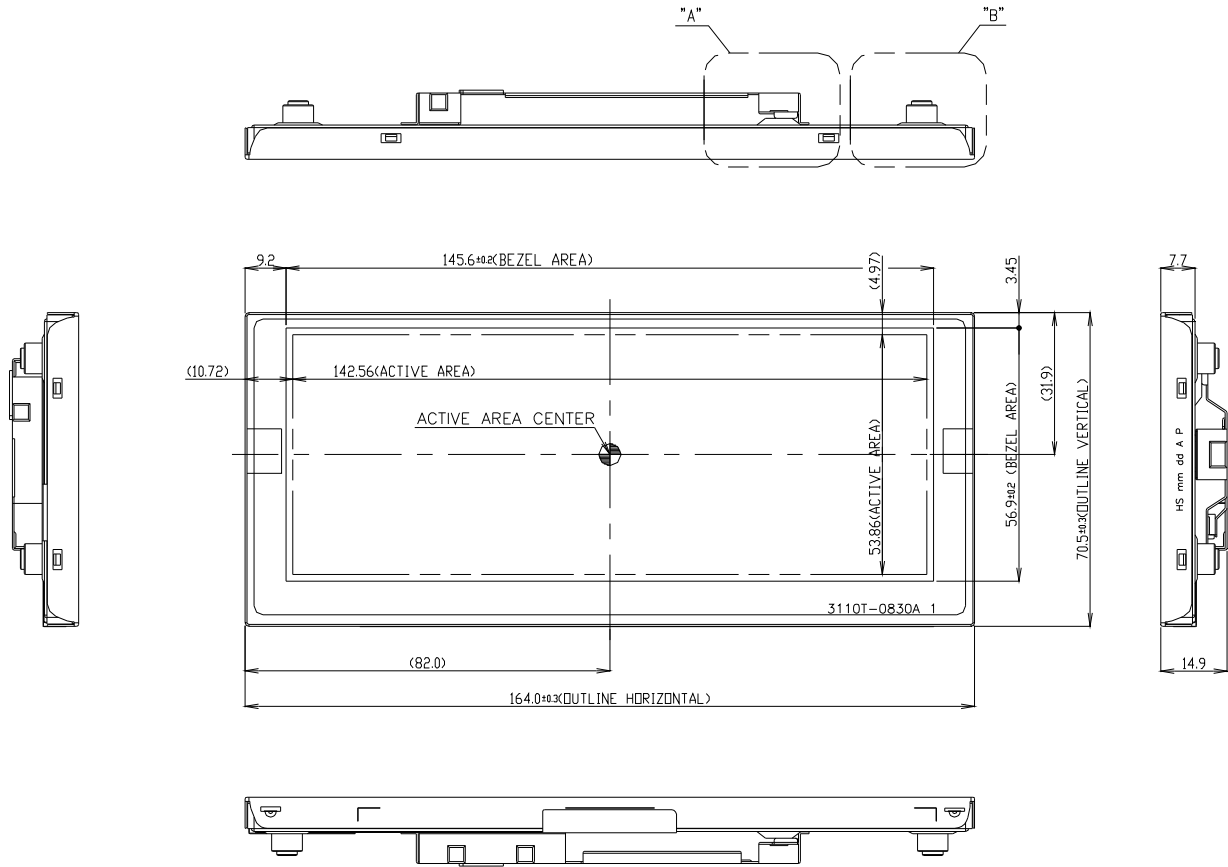

**Product Specifications**

<REAR VIEW>

Note) Unit:[mm], General tolerance: ± 0.3mm

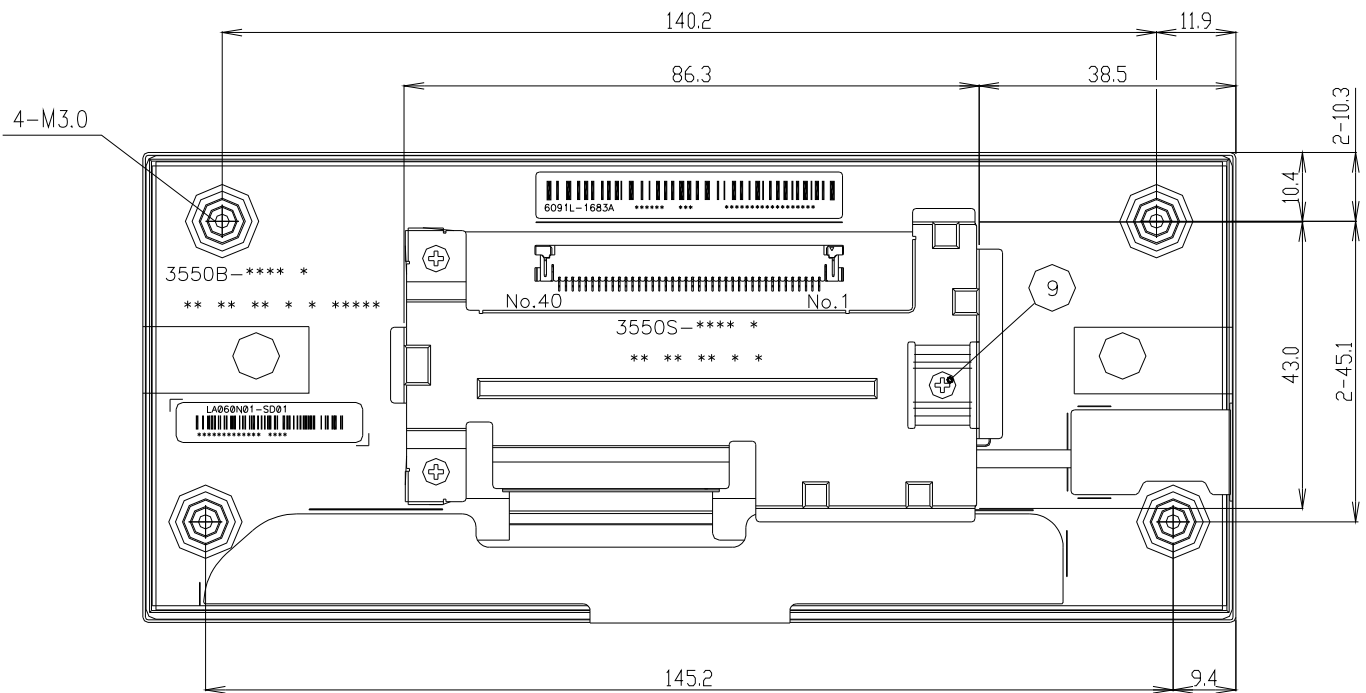

## Product Specifications

### 8. Reliability Test

• Ta ; Ambient Temperature

No.	Test Item	Test Condition	Note
1	High Temperature Storage Test	Ta=85℃ 240h	
2	Low Temperature Storage Test	Ta=-40℃ 240h	
3	High Temperature Operation Test	Ta=85℃ 240h	
4	Low Temperature Operation Test	Ta=-30℃ 240h	
5	High Humidity Operation Test	Ta=65℃/90%RH 240h	
6	Humid Heat Cyclic Test	Ta=-10℃~65℃/80~96%RH 240h	
7	Thermal Shock Test	- 1cycle : Ta=-40℃(0.5h) ~ 85℃(0.5h) - 240Cycles	
8	Electro Static Discharge Test	- Panel Surface : ±15kV, Air, Power On - Case Top, Cover Bottom : ±10kV, Direct, Power Off (Air : 330pF,2kΩ / Direct : 150pF,2kΩ / 10 times)	
9	Shock Test (non-operating)	Half sine wave, 50G, 11ms, three times One in each opposite direction of each perpendicular axis	
10	Vibration Test (non-operating)	- 5Hz to 200Hz logarithm sweep for 20min/cycle. - 5Hz to 12.2Hz:The amplitude is 10mm p-p. - 12.2Hz to 100Hz:The acceleration is 3.0G 0-pk. - 101Hz to 200Hz:The acceleration is 1.5G 0-pk. - 3 axes, 18 sweeps per axis	
11	Vibration Test Temperature Cycle	-10Hz to 1000Hz, 20.9G, -40℃~70℃ - 8H×3Cycle	

**Notes:**

1. In the Reliability Test, Confirm performance after leaving in room temp(25℃)
2. In the standard condition, there shall be no practical problems that may affect the display function 24 hours later after reliability test.

**Product Specifications****9. International Standards****9-1. Safety**

- a) UL 60950-1, Second Edition, Underwriters Laboratories Inc.  
Information Technology Equipment - Safety - Part 1 : General Requirements.
- b) CAN/CSA C22.2 No.60950-1-07, Second Edition, Canadian Standards Association.  
Information Technology Equipment - Safety - Part 1 : General Requirements.
- c) EN 60950-1:2006 + A11:2009, European Committee for Electrotechnical Standardization (CENELEC).  
Information Technology Equipment - Safety - Part 1 : General Requirements.

**9-2. Environment**

- a) RoHS, Directive 2002/95/EC of the European Parliament and of the council of 27 January 2003



**Product Specifications**
**10. Packing**
**10-1. Designation of Lot Mark**

a) Lot Mark

 A,B,C: SIZE(INCH)  
 E: MONTH

 D: YEAR  
 F ~ M: SERIAL NO.

Note

1. YEAR

Year	2011	2012	2013	2014	2015	2016	2017	2018	2019	2020
Mark	A	B	C	D	E	F	G	H	J	K

2. MONTH

Month	Jan	Feb	Mar	Apr	May	Jun	Jul	Aug	Sep	Oct	Nov	Dec
Mark	1	2	3	4	5	6	7	8	9	A	B	C

b) Location of Lot Mark

Serial No. is printed on the label. The label is attached to the backside of the LCD module.  
 This is subject to change without prior notice.

**Product Specifications**

**10-2. Packing Form**

- a) Package quantity in one box : 42 pcs
- b) Box Size : 478 x 365 x 244 (mm)

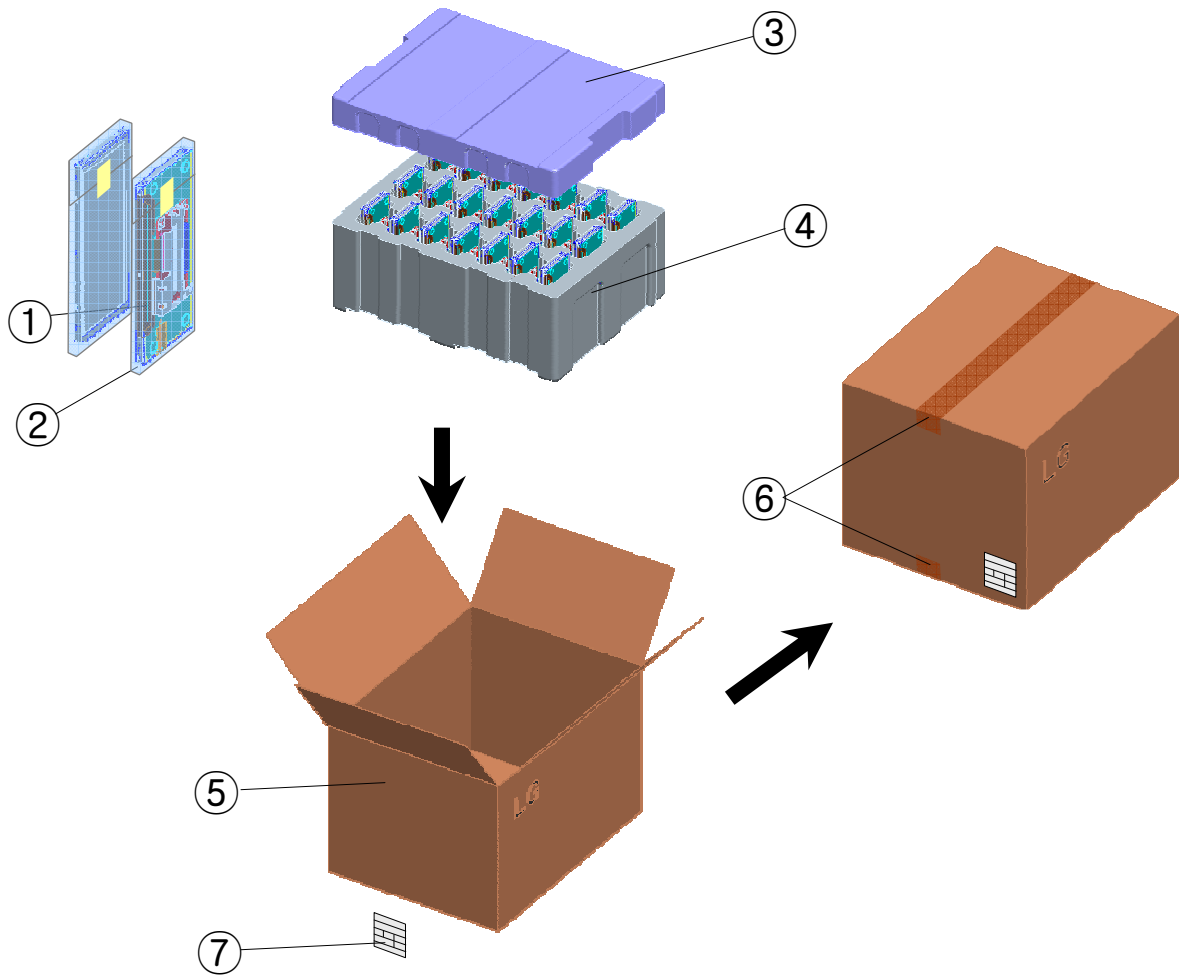

NO.	Description	Material
1	Module	42pcs/1 Box
2	Bag	PE, 100x210
3	Packing, Top	EPS
4	Packing, Bottom	EPS
5	Box	SWR4, 478X365X244
6	Tape	OPP 70MMx300m
7	Label	YUPO Paper 100x70

## Product Specifications

### 11. PRECAUTIONS

Please pay attention to the following when you use this TFT LCD module.

#### 11-1. MOUNTING PRECAUTIONS

- (1) You must mount a module using specified mounting holes.(Details refer to the drawings)
- (2) You should consider the mounting structure so that uneven force(ex. Twisted stress) is not applied to the module.  
And the case on which a module is mounted should have sufficient strength so that external force is not transmitted directly to the module.
- (3) Please attach a transparent protective plate to the surface in order to protect the polarizer.  
Transparent protective plate should have sufficient strength in order to the resist external force.
- (4) You should adopt radiation structure to satisfy the temperature specification.
- (5) Acetic acid type and chlorine type materials for the cover case are not desirable because the former generates corrosive gas of attacking the polarizer at high temperature and the latter causes circuit break by electro-chemical reaction.
- (6) Do not touch, push or rub the exposed polarizers with glass, tweezers or anything harder than HB pencil lead. And please do not rub with dust clothes with chemical treatment.  
Do not touch the surface of polarizer for bare hand or greasy cloth.(Some cosmetics deteriorate the polarizer.)
- (7) When the surface becomes dusty, please wipe gently with absorbent cotton or other soft materials like chamois soaks with petroleum benzine. Normal-hexane is recommended for cleaning the adhesives used to attach front / rear polarizers. Do not use acetone, toluene and alcohol because they cause chemical damage to the polarizer.
- (8) Wipe off saliva or water drops as soon as possible. Their long time contact with polarizer causes deformations and color fading.
- (9) Do not open the case because inside circuits do not have sufficient strength.
- (10) The metal case of a module should be contacted to electrical ground of your system.

#### 11-2. OPERATING PRECAUTIONS

- (1) Response time depends on the temperature.(In lower temperature, it becomes longer.)
- (2) Brightness depends on the temperature. (In higher temperature, it becomes lower.)
- (3) Be careful for condensation at sudden temperature change. Condensation makes damage to polarizer or electrical contacted parts. And after fading condensation, smear or spot will occur.
- (4) When fixed patterns are displayed for a long time, remnant image is likely to occur.
- (5) Module has high frequency circuits. Sufficient suppression to the electromagnetic interference shall be done by system manufacturers. Grounding and shielding methods may be important to minimize the interference.

## Product Specifications

### 11-3. ELECTROSTATIC DISCHARGE CONTROL

Since a module is composed of electronic circuits, it is not strong to electrostatic discharge. Make certain that treatment persons are connected to ground through wrist band etc. And don't touch interface pin directly.

### 11-4. PRECAUTIONS FOR STRONG LIGHT EXPOSURE

Strong light exposure causes degradation of polarizer and color filter.

### 11-5. STORAGE

When storing modules as spares for a long time, the following precautions are necessary.

- (1) Store them in a dark place. Do not expose the module to sunlight or fluorescent light. Keep the temperature between 5°C and 35°C at normal humidity.
- (2) The polarizer surface should not come in contact with any other object.  
It is recommended that they be stored in the container in which they were shipped.

### 11-6. HANDLING PRECAUTIONS FOR PROTECTION FILM

- (1) The protection film is attached to the bezel with a small masking tape or a double side tape.  
When the protection film is peeled off, static electricity is generated between the film and polarizer.  
This should be peeled off slowly and carefully by people who are electrically grounded and with well ion-blown equipment or in such a condition, etc.
- (2) When the module with protection film attached is stored for a long time, sometimes there remains a very small amount of glue still on the bezel after the protection film is peeled off.
- (3) You can remove the glue easily. When the glue remains on the bezel surface or its vestige is recognized, please wipe them off with absorbent cotton waste or other soft material like chamois soaked with normal-hexane.

# Incoming Inspection Standard

**Size : 6.0 Inch**

**Model : LA060N01-SD01**

**Customer : Hyundai Mobis**

**Date : 1<sup>st</sup> Jun. 2011**

Prepared by : S.J. Kwon



Checked by : D.H. Kim



Approved by : H.B. Jeon



Mobile/ OLED CS Team  
LG Display Co., LTD.

## Customer's Approval

Reviewed & Approved by

(NAME) .....

(TITLE) .....

(Signature) .....

(Date) .....(MM)/.....(DD)/.....(YY).....

**Please (return / keep) this standard with your signature for approval**

## Contents

Revision Status .....	3
1.0. Introduction	
1.1. Scope .....	4
1.2. Incoming Inspection Right .....	4
1.3. Handling Precautions .....	4
2.0. Generals	
2.1. Sampling Method .....	5
2.2. Acceptable Quality Level(AQL) .....	5
2.3. Classification of defects .....	5
2.4. Determination of acceptability and subsequent disposal .....	5
2.5. Inspection Conditions .....	6
3.0. Inspection Criteria	
3.1. Dot Defect .....	7
3.2. Polarizer Defect .....	8
3.3. Foreign Material .....	9
3.4. Mura .....	9
3.5. LCM Appearance .....	10
3.6. Line Defect .....	11
3.7. Others .....	11
4.0. RMAs	
4.1. Verification .....	12
4.2. Supplier Induced Defects .....	12
4.3. Customer Induced Defects .....	12
5.0. Warranty	
5.1. Warranty Period .....	13
5.2. Repair Warranty .....	13
5.3. Warranty avoidance .....	13
6.0. Others .....	13
Appendix A .....	14

## **Revision Status**

---

Rev. No.	Chapter	Contents	Date	Issued & amended by
1.0	All	Originated IIS	01/ June/ 2011	S.J. Kwon

---

## 1.0 Introduction

---

### 1.1. Scope

This Incoming Inspection Standard shall be applied to TFT-LCD modules (hereafter called the "LCMs") supplied by LG Display (hereafter called the "Supplier") to its Customer.

### 1.2. Incoming inspection Right

The Customer shall have the right to conduct at its own cost and expense, an incoming inspection of the LCMs at the destination specified in the relevant B/L (Bills of Lading) in accordance with the LCM's specifications separately agreed upon and the inspection criteria set forth in this article.

The Customer shall notify the Supplier in writing of the inspection results (accept or reject) in accordance with the said Incoming Inspection Standard within 40 days from the date of the B/L.

Should the Customer fail to notify the results to Supplier within 40 days period, the right to reject the LCMs shall then lapse, and the said LCMs shall be deemed to have been accepted by the Customer.

### 1.3. Handling Precautions

- LCM Devices are made of fragile material such as Glass and plastic and may be broken or cracked if dropped it, so **PLEASE** handle them with care.
- **DO NOT** press the area covered with PET or such materials. These are weak point of LCMs since of TCPs(Driver ICs) and PWBs.
- **PLEASE** support the Bezel with your finger when connecting the interface cable.
- Please **DO NOT** touch the surface of the Glass(Polarizer).
- **PLEASE** wear the Wrist Strap when handling.  
Semiconductive devices are included in the LCMs and they should be handled with care to prevent any electrostatic discharge(ESD).
- **PLEASE** keep the LCMs in the specified, original packing boxes when storage.
- **DO NOT** stack the LCMs too high without wrapping material such as AIR CAP.
- Before using the LCMs, **PLEASE** check the Engineering specification.
- LCMs contain a small amount of Liquid Crystal and Mercury. **PLEASE** follow local ordinances or regulations for disposal.



## 2.0 Generals

---

### 2.1. Sampling Method

Unless otherwise agreed upon in writing, the sampling inspection shall be applied to the Customer's incoming inspection.

- 2.1.1. Lot size : Quantity per shipment lot (minimum lot size : 100 pieces)
- 2.1.2. Sampling type : Normal inspection, Single sampling
- 2.1.3. Inspection level : II
- 2.1.4. Sampling table : ANSI Z1.4

### 2.2. Acceptable Quality Level(AQL)

The AQL for major and minor defects shall be respectively set forth below.

- 2.2.1. **Major = 0.4%**
- 2.2.2. **Minor = 1.0 %**

### 2.3. Classification of defects

Defects are classified as either a major defect or a minor defect based on the degree of defect defined herein.

#### 2.2.1. Major defect

The major defect is a defect that is likely to result in product failure, or reduction in the product's intended usage.

#### 2.2.2. Minor defect

The minor defect is a defect that has little bearing on the effective use or operation of the product.

Specific criteria of judgment of major and/or minor defects or other related issues shall be in accordance with the Appendix A, "Classification of Defects".

### 2.4. Determination of acceptability and subsequent disposal

If the number of defects found in the LCM sampling lot is equal to or less than the AQL(Acceptable Quality Level), the lot shall be accepted.

If the number of defects found in the LCM sampling lot is greater than the AQL, the lot shall be rejected. The Customer shall inform the Supplier of the results of such inspection detailly within the time period stipulated in chapter 1.2. "Incoming inspection Right".

### 2.4.1. Accepted lot

An acceptance under the above incoming inspection shall constitute an acceptance by the Customer of such lot of the LCMs in terms of the landed quality thereof.

### 2.4.2. Rejected lot

If a shipment lot of products is rejected under the above incoming inspection due to any defects of which the Supplier is responsible and such a fact is clearly confirmed by the Supplier through a separate inspection or as otherwise decided, the Supplier shall choose one of the following three options which must be determined by mutual consent.

The Supplier shall advise the Customer of its choice not later than 10 working days (Monday through Friday) of receipt of the "Customer's notification of rejected lot" :

- a. The Customer shall return the rejected lot to the place to be designated by the Supplier and the Supplier shall screen all of the products in the lot and repair or replace the defective LCMs.
- b. The Supplier shall screen all of the LCMs in the lot and repair or replace the defective LCMs within a reasonable time period at the Customer's facility.
- c. The Customer shall screen the entire lot of LCMs at the expense of Supplier's, and the expense must be agreed by the Supplier. The rejected LCMs shall be returned to the place designated by the Supplier.

## 2.5. Inspection Conditions

Viewing Distance	30~40cm		
Ambient illumination	Operating Inspection	50~150 lux	
	Visual Inspection	300~700 lux	
Viewing angle	Within 30 degrees left, right, up and down as the right picture shown		
Ambient temperature	23±3 °C		
Display patterns	R, G, B, Black, Half Gray, White		
Inspection zone	Active area which is operating with pixels.		
ND Filter	Viewing angle	90±5 °	
	Distance	30~40cm	

### 3.0 Inspection Criteria

#### 3.1. Dot Defects

##### 3.1.1. Bright Dots

Dots(sub-pixels) which appear bright in the screen when the LCM operates with Black or Half gray patterns. (Including bright dots caused by foreign material)

Items		Criteria (acceptable level)	
Bright Dots	R,G or B 1 dot	$N \leq 0$	※ Weak bright Dot It would not be counted as a bright dot. But full screen pattern with half gray must not show weak bright dots.
	Adjacent 2 dots	$N \leq 0$	
	Minimum distance	disregarded	
	Density	$N \leq 0$	
	total	$N \leq 0$	

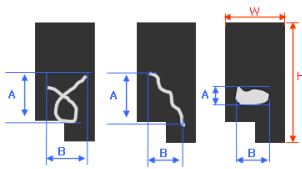
Defect Modes	Bright dot types	Inspection standards
C/F damage, Domain, Foreign material in Panel		• <b>Inspection Patterns</b> : Black, R,G,B, Half gray
Foreign material in POL, POL bubble		

##### 3.1.2. Dark Dots

Dots(sub-pixels) which appear dark in the screen when the LCM operates with White or Half gray patterns.

Items		Criteria (acceptable level)	
Dark Dots	1 dot	$N \leq 2$	It would not be counted as a dark dot when Dot is not visible using <b>5% ND Filter</b> , although it is visible with naked eyes
	Adjacent 2 dots	$N \leq 1$	
	Minimum distance	$L \geq 10\text{mm}$	
	total	$N \leq 3$	

### 3.0 Inspection Criteria

#### 3.1.2. Dark Dot

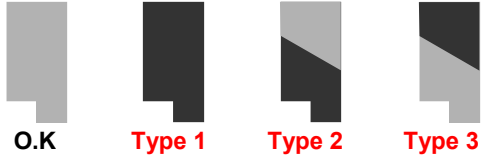
Defect Modes	Dark Dot types	Inspection standards
Pixel off	 <p>O.K      Type 1      Type 2      Type 3</p>	<ul style="list-style-type: none"> <li>• <b>Inspection Patterns</b> : White, R, G, B, Half gray</li> </ul>

### 3.2. Polarizer Defects

Items		Criteria(acceptable level)	
Scratches	Linear	Width	$0.05 \leq W \leq 0.1$
		Length	$0.1 \leq L \leq 5.0$
		Quantity	$N \leq 2$
Dent or Bubble	Circular	Diameter	$0.1 \leq D \leq 0.2$
		Quantity	$N \leq 2$

1. Extraneous substance which can be wiped out, like Finger Print, Particles, are not considered as a defect.  
 2. Defects which are on the Black Matrix(outside of Active Area) are not considered as a defect.

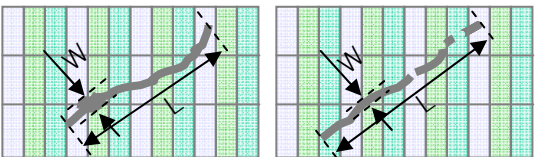
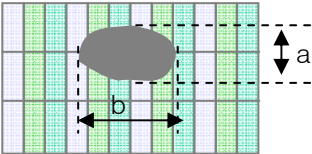
Defect modes	Definition	Inspection standards
Scratches		<ul style="list-style-type: none"> <li>• <b>Inspection patterns</b> : White, Half Gray</li> </ul> <p><math>L &gt; 4W</math> : considered as Linear  <math>L \leq 4W</math> : considered as Circular</p> <p>W: widest point [mm]                      L : longest point [mm]</p> <p><math>D = (a+b)/2</math></p>
Dent or Bubble		

### 3.3 Foreign Material (Polarizer, Backlight)



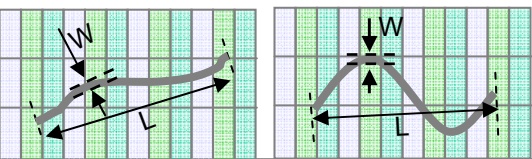
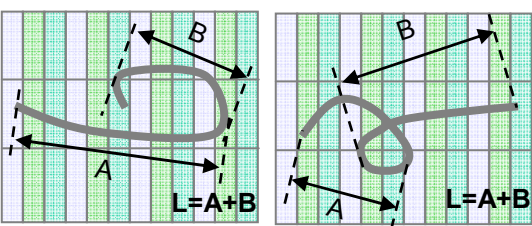
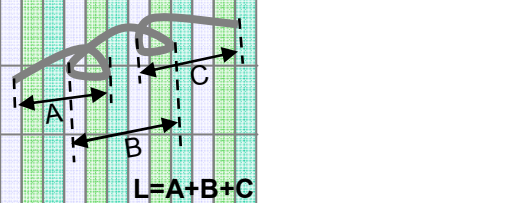
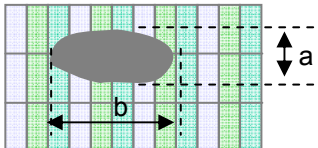

Items		Criteria(acceptable level)	
Linear	Width	$0.05 \leq W \leq 0.1$	In the case of foreign material in Polarizer which appears bright, it is based on inspection standards of Bright Dot.
	Length	$0.1 \leq L \leq 5.0$	
	Quantity	$N \leq 2$	
Circular	Diameter	$0.1 \leq D \leq 0.2$	
	Quantity	$N \leq 2$	

Defect modes	Definition	Inspection standards
Linear		<p><math>L &gt; 4W</math> : considered as Linear  <math>L \leq 4W</math> : considered as Circular</p> <p>W: widest point [mm]  L : longest point [mm]</p> <p><math>D = (a+b)/2</math></p> <p>• Inspection Pattern :  White, Half Gray</p>
		
		
Circular		

### 3.4 Mura

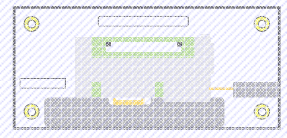
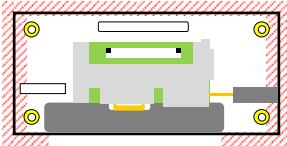
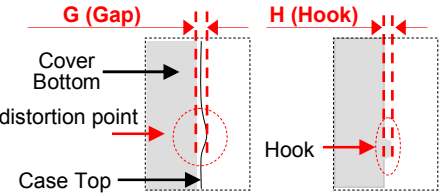
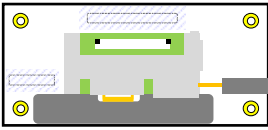
Mura which appears in the screen when the LCM displayed. **(Using 1% ND Filter)**  
It would not be counted as Mura, although it is visible with naked eyes

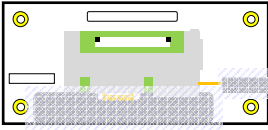
### 3.5. LCM Appearance

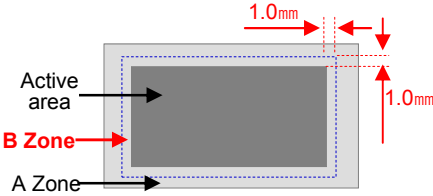
Items	Specifications	Acceptable Number	Remark
<p>Cover Shield</p> 	<ul style="list-style-type: none"> <li>• <b>Discoloration, Scratch, Dent</b> : It is O.K if it is not over 50% of the whole area.</li> <li>• <b>It is O.K if it does not affect function/operation of LCM.</b></li> </ul>	disregarded	
<p>Case Top distortion</p> 	<ul style="list-style-type: none"> <li>• <b>Case Top Hook must be fully locked.</b></li> <li>• <b>Partial distortion</b> : <math>G &lt; H</math></li> </ul> 	disregarded	<p>G : Gap between Cover Bottom and Case Top (or Gap between Cover Bottom and Support Main)</p> <p>H : Height of Hook</p>
<p>Label</p> 	<ul style="list-style-type: none"> <li>• <b>Although label printing is not clear, it is acceptable if scanners can read label information.</b></li> </ul> 	disregarded	
<p>Adhesive Tape damage</p> 	<ul style="list-style-type: none"> <li>• <b>Although Adhesive Tape has Dent or Scratch and is pressed, it is acceptable if FPC is not exposed.</b></li> </ul>	disregarded	
<p>POL</p> 	<ul style="list-style-type: none"> <li>• <b>It is O.K if it is wiped up.</b> : It could be cleaned by rubbing</li> </ul>	disregarded	
<p>Case Top [Front metal frame]</p> 	<ul style="list-style-type: none"> <li>• <b>Scratch, Dent and Distortion in the B zone are not allowed.</b></li> </ul> 	disregarded	

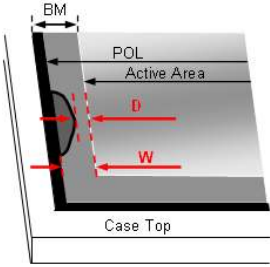
Items	Specifications	Acceptable Number	Remark
<p>POL [Polarizer] edge looseness : Not firmly attached.</p> 	<ul style="list-style-type: none"> <li>• <b>Upper Polarizer</b> : <math>D \geq 0.5\text{mm}</math></li> <li>• <b>Lower Polarizer</b> : It is O.K if it does not affect function/operation of LCM.</li> </ul> <p>* Bezel Open and Close Type have the same inspection standards.</p>	<p>disregarded</p>	 <p>* In the case of Bezel Close, <math>W = \text{BM}</math> [Black Matrix]</p>

### 3.6. Line Defect

All kinds of line defects such as vertical, horizontal or cross are not allowed.

### 3.7. Others

Issues which are not defined in this criteria shall be discussed with both parties, Customer and Supplier, for better solution.

## **4.0 RMAs**

---

### **4.1. Verification**

The Supplier can verify the defective LCMs to segregate the responsibilities at Customer's facility or can request the Customer to ship the defective LCMs to assigned place for verification

This verification result shall be agreed mutually by the Customer and Supplier. This result can be corrected/changed after detail failure analysis at Supplier's facilities.

### **4.2. Supplier Induced Defects**

All of the Supplier induced defective LCMs shall be returned to the Supplier for repair or replacement.

Before return the defective LCMs, the Customer needs Supplier's confirmation with RMA Number.

All of the returned LCMs shall be returned to the Customer within agreed time period.

### **4.3. Customer Induced Defects**

The Customer can return the customer induced defective LCMs to the Supplier for repair.

The repair cost for Customer induced defective LCMs shall be agreed with both parties, Customer and Supplier.



## 5.0 Warranty

---

### 5.1. Warranty Period

In-warranty period is **Eighteen(18)** Months from manufacturing month of LCM.

Note)

- a. Eighteen months are composed of twelfth months in-warranty period and sixth months distribution period.
- b. The manufacturing Month is on the LCMs as Supplier's serial No.
- c. If customer want to extend warranty, customer should pay 0.5% of a unit cost per 6months.

### 5.2. Repair Warranty

Repair warranty is **Twelve(12)** Months from repaired month for repaired LCMs.

Note) The Label for repair will be added after repairing.

### 5.3. Warranty avoidance

The warranty will be avoided in cases of below,

- a. When the warranty period is expired
- b. The Customer induced defective LCMs
- c. When the LCMs were repaired by 3rd party without Supplier's approval.
- d. When the LCMs were treated like Disassemble and Rework by the Customer and/or Customer's representatives without Supplier's approval.

## 6. Others

If any problems arise with the LCMs supplied by supplier, the Customer and Supplier will cooperate and make efforts to solve it with mutual confidence and respect.

---

## Appendix A. Classification of Defects

---

Defect Mode	Criterion for Defect	Class
Operating Frequency	Specified range in the CAS	Major
Power Consumption	Specified range in the CAS	Major
Contrast Ratio	Specified range in the CAS	Major
Line Defect	Not allowed any Vertical, Horizontal, and Cross line	Major
Polarizer Defects	Shall be accordance with the item 3.0 "Inspection Criteria" in this standard	Minor
Extraneous Substance	Shall be accordance with the item 3.0 "Inspection Criteria" in this standard	Minor
Dot Defect	Shall be accordance with the item 3.0 "Inspection Criteria" in this standard	Minor
Bezel Claw Forming	The bezel claw is not formed sufficiently	Minor