

TFT-DISPLAY DATASHEET

ONation
Model: OT070PGDDLV-00

BRIEF SPEC.:

Main Feature

Landscape Type

White LED Backlight

Active Screen Area

154,08 x 85.92 [mm]

Diagonal | Format

7" | 15:9

Resolution

800 x 480

Colors

R.G.B Stripe 16,7M

Backlight

LED, Edge-Light

Brightness

400 cd/m²

LED Life Time

20.000h (Typ.)

Interface

LVDS

Viewing Angle

-60~70(H), -40~50(V)

Touchscreen

no

Power Supply

3,3V (Typ.)

Module Outline

164,9 x 100 x 9.2 [mm]

Operation Temperature

-30... +85 °C

Storage Temperature

-30... +85 °C

Surface Treatment

Anti-Glare



ONation Corporation

TFT COLOR LCD MODULE

MODEL: OT070PGDDLX-00

WVGA
LVDS interface(1port)

Version: P0.4

Customer : _____
Approved By : _____
Date: _____

ONATION		
APPROVAL	CHECKER	PREPARE
<i>Ian</i>	<i>Josh</i>	<i>Aiden</i>

[All information is subject to change without notice.](#)
[Please confirm the sales representative before starting to design your system](#)

CONTENTS

NO.	ITEM	PAGE
1	RECORD OF REVISION	0-1~0-2
2	MECHANICAL SPECIFICATIONS	1
3	OUTLINE DIMENSIONS	2
4	INTERFACE PIN CONNECTION	3
5	BLOCK DIAGRAM	4
6	ABSOLUTE MAXIMUM RATINGS	4
7	ELECTRICAL CHARACTERISTICS	5
8	OPTICAL CHARACTERISTICS	6~8
9	TIMING SPECIFICATIONS	9~10
10	RELIABILITY TEST	11~12
11	MODEL NUMBER SYSTEM	13
12	LCM INSPECTION STANDARD	14
13	PACKAGE INFORMATION	14
14	PRECAUTIONS FOR USE	15

1.RECORD OF REVISION

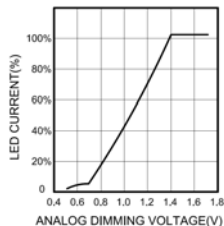
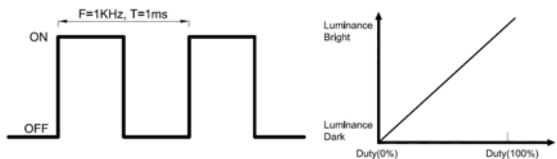
REV	DATE	PAGE	SUMMARY																																										
0.1	2014.03.10	ALL	Preliminary specification was first issued.																																										
0.2	2014.03.24	6	<p>Add: 7.2 BACKLIGHT UNITS</p> <table border="1"> <thead> <tr> <th>ITEM</th> <th>SYMBOL</th> <th>MIN.</th> <th>TYP.</th> <th>MAX.</th> <th>UNIT</th> <th>REMARK</th> </tr> </thead> <tbody> <tr> <td>ADJ Input Analog Dimming Voltage</td> <td>-</td> <td>0.7</td> <td>-</td> <td>1.4</td> <td>VDC</td> <td>Note 3</td> </tr> <tr> <td>ADJ Input PWM Dimming Voltage</td> <td>-</td> <td>1.4</td> <td>-</td> <td>5.0</td> <td>Vp-p</td> <td>Note 4</td> </tr> <tr> <td>ADJ Frequency</td> <td>-</td> <td>100</td> <td>-</td> <td>1000</td> <td>Hz</td> <td></td> </tr> </tbody> </table> <p>Note 3: When the ADJ pin voltage rises from 0.7VDC to 1.4VDC, the LED current will change from 0% to 100% of the maximum LED current:</p>  <p>Note 4: ADJ signal Vp-p = 1.4~5.0V, operation frequency: 100Hz ~ 1 kHz PWM DIMMING DUTY</p> 	ITEM	SYMBOL	MIN.	TYP.	MAX.	UNIT	REMARK	ADJ Input Analog Dimming Voltage	-	0.7	-	1.4	VDC	Note 3	ADJ Input PWM Dimming Voltage	-	1.4	-	5.0	Vp-p	Note 4	ADJ Frequency	-	100	-	1000	Hz															
ITEM	SYMBOL	MIN.	TYP.	MAX.	UNIT	REMARK																																							
ADJ Input Analog Dimming Voltage	-	0.7	-	1.4	VDC	Note 3																																							
ADJ Input PWM Dimming Voltage	-	1.4	-	5.0	Vp-p	Note 4																																							
ADJ Frequency	-	100	-	1000	Hz																																								
0.3	2014.05.05	6	<p>Change: 7.1 ELECTRICAL CHARACTERISTICS OF LCD</p> <table border="1"> <thead> <tr> <th>ITEM</th> <th>SYMBOL</th> <th>MIN.</th> <th>TYP.</th> <th>MAX.</th> <th>UNIT</th> <th>REMARK</th> </tr> </thead> <tbody> <tr> <td>Power</td> <td>VDD</td> <td>3.0</td> <td>3.3</td> <td>3.6</td> <td>V</td> <td></td> </tr> <tr> <td>Voltage For LCD</td> <td>IDD</td> <td>-</td> <td>TBD</td> <td>TBD</td> <td>mA</td> <td>Note1</td> </tr> </tbody> </table> <p style="text-align: center;">↓</p> <table border="1"> <thead> <tr> <th>ITEM</th> <th>SYMBOL</th> <th>MIN.</th> <th>TYP.</th> <th>MAX.</th> <th>UNIT</th> <th>REMARK</th> </tr> </thead> <tbody> <tr> <td>Power</td> <td>VDD</td> <td>3.0</td> <td>3.3</td> <td>3.6</td> <td>V</td> <td></td> </tr> <tr> <td>Voltage For LCD</td> <td>IDD</td> <td>-</td> <td>82</td> <td>100</td> <td>mA</td> <td>Note1</td> </tr> </tbody> </table>	ITEM	SYMBOL	MIN.	TYP.	MAX.	UNIT	REMARK	Power	VDD	3.0	3.3	3.6	V		Voltage For LCD	IDD	-	TBD	TBD	mA	Note1	ITEM	SYMBOL	MIN.	TYP.	MAX.	UNIT	REMARK	Power	VDD	3.0	3.3	3.6	V		Voltage For LCD	IDD	-	82	100	mA	Note1
ITEM	SYMBOL	MIN.	TYP.	MAX.	UNIT	REMARK																																							
Power	VDD	3.0	3.3	3.6	V																																								
Voltage For LCD	IDD	-	TBD	TBD	mA	Note1																																							
ITEM	SYMBOL	MIN.	TYP.	MAX.	UNIT	REMARK																																							
Power	VDD	3.0	3.3	3.6	V																																								
Voltage For LCD	IDD	-	82	100	mA	Note1																																							

REV	DATE	PAGE	SUMMARY																					
0.3	2014.05.05	6	7.2 BACKLIGHT UNITS																					
			<table border="1"> <thead> <tr> <th>ITEM</th> <th>SYMBOL</th> <th>MIN.</th> <th>TYP.</th> <th>MAX.</th> <th>UNIT</th> <th>REMARK</th> </tr> </thead> <tbody> <tr> <td>LED Driving Voltage</td> <td>VLED</td> <td>-</td> <td>5</td> <td>12</td> <td>V</td> <td>Note 1</td> </tr> <tr> <td>LED Driving Current</td> <td>ILED</td> <td>-</td> <td>TBD</td> <td>TBD</td> <td>mA</td> <td></td> </tr> </tbody> </table>	ITEM	SYMBOL	MIN.	TYP.	MAX.	UNIT	REMARK	LED Driving Voltage	VLED	-	5	12	V	Note 1	LED Driving Current	ILED	-	TBD	TBD	mA	
			ITEM	SYMBOL	MIN.	TYP.	MAX.	UNIT	REMARK															
LED Driving Voltage	VLED	-	5	12	V	Note 1																		
LED Driving Current	ILED	-	TBD	TBD	mA																			
↓																								
0.4	2014.08.19	2 13	<table border="1"> <thead> <tr> <th>ITEM</th> <th>SYMBOL</th> <th>MIN.</th> <th>TYP.</th> <th>MAX.</th> <th>UNIT</th> <th>REMARK</th> </tr> </thead> <tbody> <tr> <td>LED Driving Voltage</td> <td>VLED</td> <td>-</td> <td>5</td> <td>12</td> <td>V</td> <td>Note 1</td> </tr> <tr> <td>LED Driving Current</td> <td>ILED</td> <td>-</td> <td>420</td> <td>470</td> <td>mA</td> <td></td> </tr> </tbody> </table>	ITEM	SYMBOL	MIN.	TYP.	MAX.	UNIT	REMARK	LED Driving Voltage	VLED	-	5	12	V	Note 1	LED Driving Current	ILED	-	420	470	mA	
			ITEM	SYMBOL	MIN.	TYP.	MAX.	UNIT	REMARK															
			LED Driving Voltage	VLED	-	5	12	V	Note 1															
LED Driving Current	ILED	-	420	470	mA																			
Change: 3. OUTLINE DIMENSIONS																								
Change: 11.MODEL NUMBER SYSTEM																								

2.MECHANICAL SPECIFICATIONS

(1)	Number Of Dots (Dots)	800(R.G.B) X 480
(2)	Module Size(mm)	164.9(H) X 100.0(V) X92(D)
(3)	Active Area(mm)	154.08(H) X 85.92(V)
(4)	Pixel Pitch(mm)	0.1926 (H) X 0.1790(V)
(5)	LCD / Polarizer Model	TFT , Transmissive, Normally/White, Anti-Glare
(6)	Backlight Color	White, LED
(7)	Viewing Direction	12O'clock Horizontal : Right side 70°(typ.), Left side 70°(typ.) Vertical : Up side 50°(typ.), Down side 70°(typ.)
(8)	Gray Scale Inversion Direction	6O'clock
(9)	Electrical Interface	LVDS Interface
(10)	Color Configuration	R.G.B Stripe,16.7M Color
(11)	Module Weight(g)	TBD

3. OUTLINE DIMENSIONS

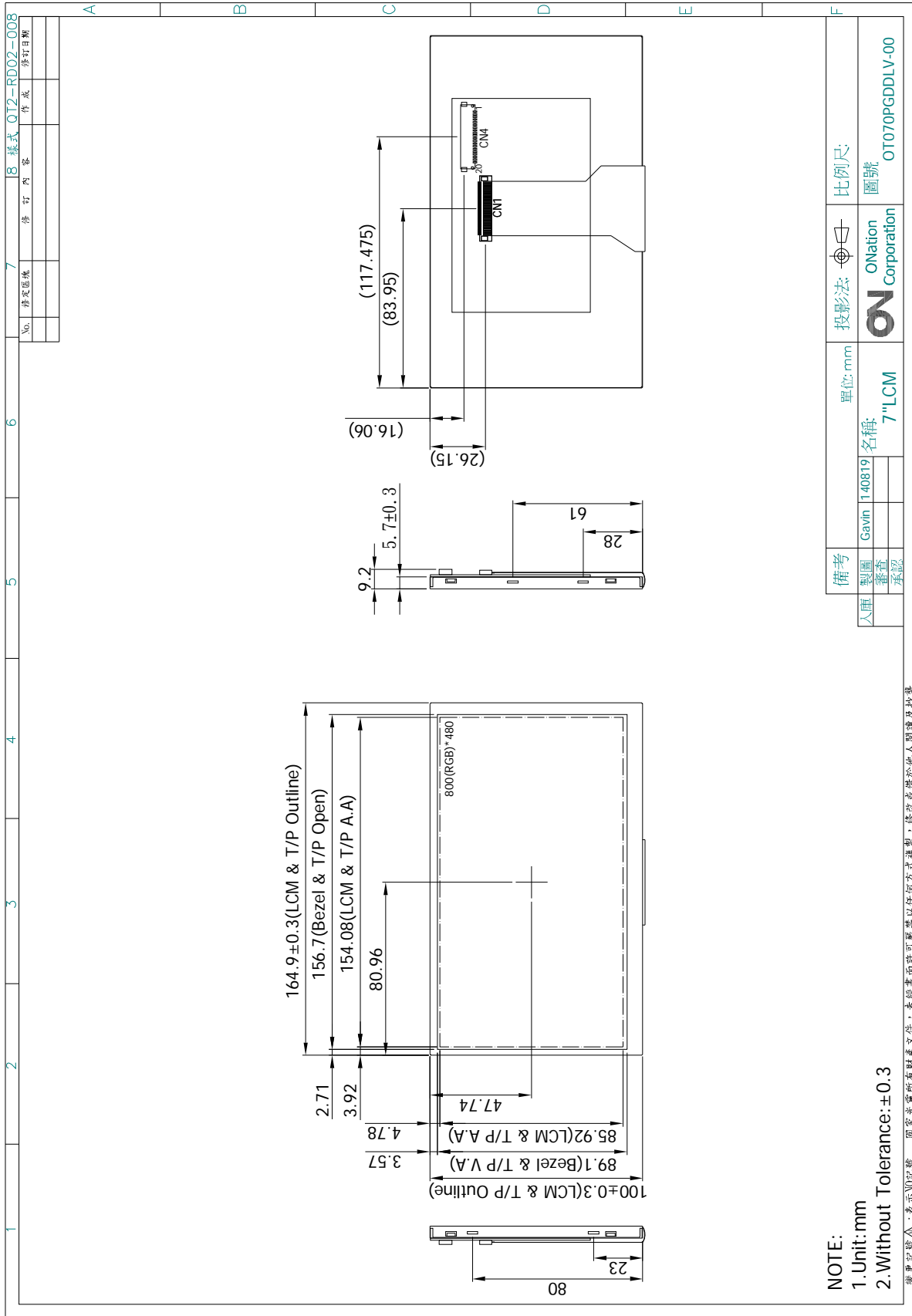

No.	修改日期	7	8 樣式 012-RD02-008
	修改內容		作成
	修改日期		

備考	單位:mm	投影法	比例尺:
人庫	Gavin	ONation Corporation	圖號
製圖	140819		OT070PGDDL-00
審查			
承認			
	名稱:		
	7"LCM		

4. INTERFACE PIN CONNECTION

4.1 LCM PANEL DRIVING SECTION

CN4 Connector : STM MS240420G or Equivalent

PIN NO.	SIGNAL	FUNCTION	REMARK
1	VDD	Digital Power	
2	VDD	Digital Power	
3	U/D	Vertical Display Mode Select Signal Up/Down Scan Control Input	Note1
4	L/R	Horizontal Display Mode Select Signal Left/Right Scan Control Input	Note1
5	RxIN0-	Differential Clock Input,CH0(Negative)	
6	RxIN0+	Differential Clock Input,CH0(Positive)	
7	GND	Ground	
8	RxIN1-	Differential Clock Input,CH1(Negative)	
9	RxIN1+	Differential Clock Input,CH1(Positive)	
10	GND	Ground	
11	RxIN2-	Differential Clock Input,CH2(Negative)	
12	RxIN2+	Differential Clock Input,CH2(Positive)	
13	GND	Ground	
14	RxCLKIN-	Differential Clock Input (Negative)	
15	RxCLKIN+	Differential Clock Input (Positive)	
16	GND	Ground	
17	VLED	Power Supply for LED Driver Circuit(5V)	
18	VLED	Power Supply for LED Driver Circuit(5V)	
19	GND	Ground	
20	ADJ	Adjust The Back Light Brightness	

Note 1: L/R&U/D scan direction setting:

Scan Control		Scan Direction
L/R	U/D	
High	Low	Left to right, up to down
High	High	Left to right, down to up
Low	High	Right to Left, down to up
Low	Low	Right to Left, up to down

5. BLOCK DIAGRAM

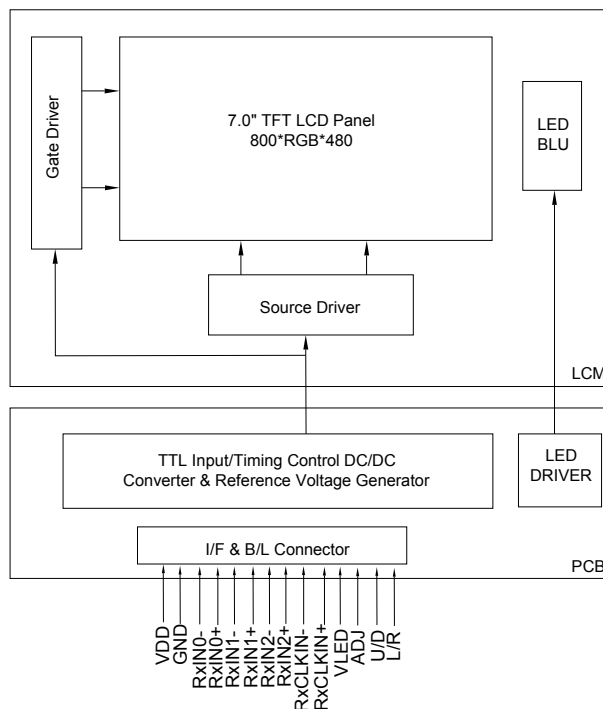

6. ABSOLUTE MAXIMUM RATINGS

6.1 ELECTRICAL ABSOLUTE MAXIMUM RATINGS

ITEM	SYMBOL	MIN.	MAX.	UNIT	REMARK
Supply Voltage	VDD	-0.3	5.0	V	
	VLED	-0.3	40	V	

6.2 ENVIRONMENTAL ABSOLUTE MAXIMUM RATINGS

ITEM	OPERATING		STORAGE		REMARK
	MIN.	MAX.	MIN.	MAX.	
Ambient Temperature(°C)	-30	85	-30	85	Note 1,2
Humidity(% RH)	Note 3		Note 3		Without condensation

Note 1 : The response time will become lower when operated at low temperature.

Note 2 : Background color changes slightly depending on ambient temperature.

Note 3 : Ta ≤ 60°C : 90%RH max , without condensation.

Ta > 60°C : Absolute humidity shall be less than the value of 90%RH at 60°C without condensation

7. ELECTRICAL CHARACTERISTICS

7.1 ELECTRICAL CHARACTERISTICS OF LCD

						Ta=25°C
ITEM	SYMBOL	MIN.	TYP.	MAX.	UNIT	REMARK
Power Voltage For LCD	VDD	3.0	3.3	3.6	V	
	IDD	-	82	100	mA	Note1

Note 1 : Test Condition: VDD=3.3V ; Test Pattern:All Black.

7.2 BACKLIGHT UNITS

						Ta=25°C
ITEM	SYMBOL	MIN.	TYP.	MAX.	UNIT	REMARK
LED Driving Voltage	VLED	-	5	12	V	Note 1
LED Driving Current	ILED	-	420	470	mA	
ADJ Input Analog Dimming Voltage	-	0.7	-	1.4	VDC	Note 3
ADJ Input PWM Dimming Voltage	-	1.4	-	5.0	Vp-p	Note 4
ADJ Frequency	-	100	-	1000	Hz	
LED Life Time	-	20000	-	-	Hrs	Note 2

Note 1: The LED Supply Voltage is defined by the number of LED at Ta=25°C and IL=420mA.

Note 2: The "LED life time" is defined as the module brightness decrease to 50% original brightness at Ta=25°C and IL=420mA. The LED lifetime could be decreased if operating IL is larger than 420mA.

Note 3: When the ADJ pin voltage rises from 0.7VDC to 1.4VDC, the LED current will change from 0% to 100% of the maximum LED current:

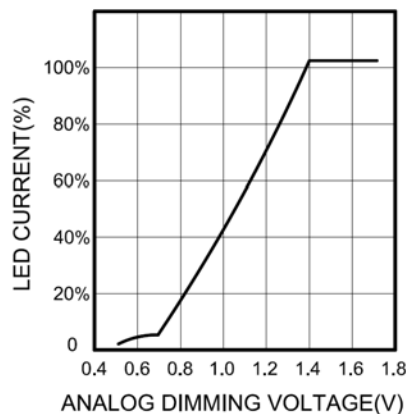

Note 4: ADJ signal Vp-p =1.4~5.0V, operation frequency: 100Hz ~ 1 kHz
PWM DIMMING DUTY

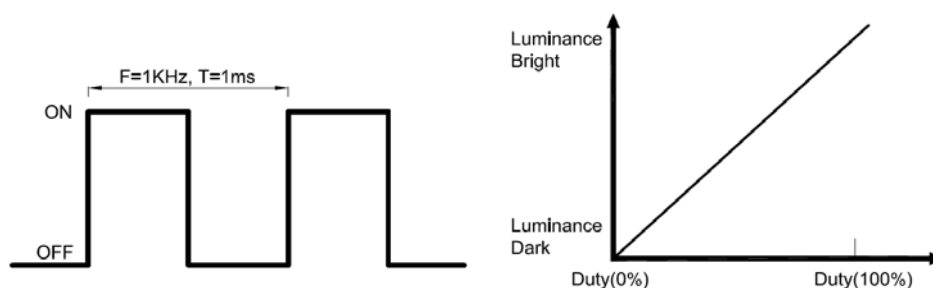

8. OPTICAL CHARACTERISTICS

Ta=25°C

ITEM	SYMBOL	CONDITIONS	MIN.	TYP.	MAX.	UNIT	REMARK
Contrast Ratio	CR	Viewing Normal Angle $\Theta_x=\Theta_y=0^\circ$	400	500	-	-	Note 1
Response Time	TR+TF		-	25	50	ms	Note 2
Chromaticity	White		x	0.260	0.310	0.360	-
		y	0.280	0.330	0.380	-	
Viewing Angle	Hor.	θ_{x+}	60	70	-	Deg.	Note 3
		θ_{x-}	60	70	-		
	Ver.	θ_{y+}	40	50	-		
		θ_{y-}	60	70	-		
Luminance	L	PWM=100%	320	400	-	cd/m ²	Note 5
Luminance Uniformity	YU		70	75	-	%	

Note 1 : Definition of Contrast Ratio (CR) :

The contrast ratio can be calculated by the following expression.

$$\text{Contrast Ratio (CR)} = L_{63}/L_0$$

L63 : Luminance of gray level 63

L0 : Luminance of gray level 0

$$CR = CR(5)$$

CR(X) is corresponding to the Contrast Ratio of the point X at Figure in Note 5

Note 2 : Definition of Response Time (TR.TF)

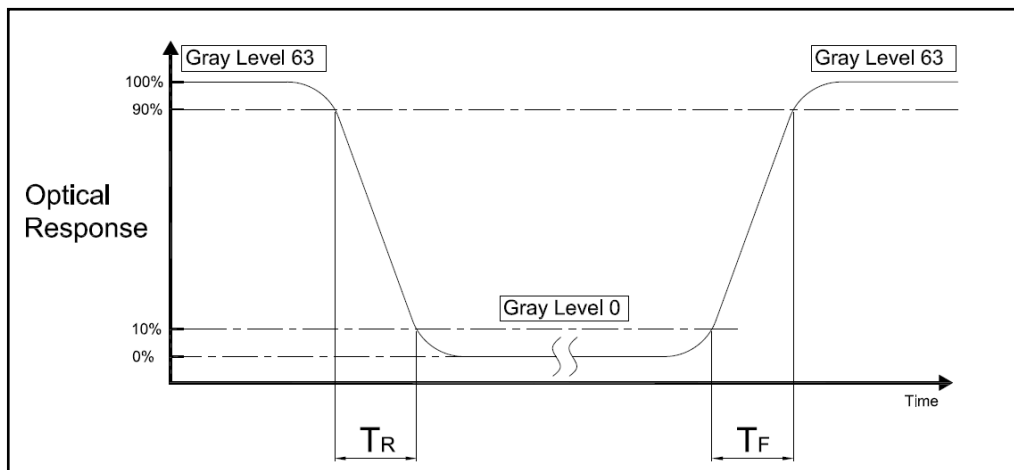

Note 3 : Definition of Viewing Angle

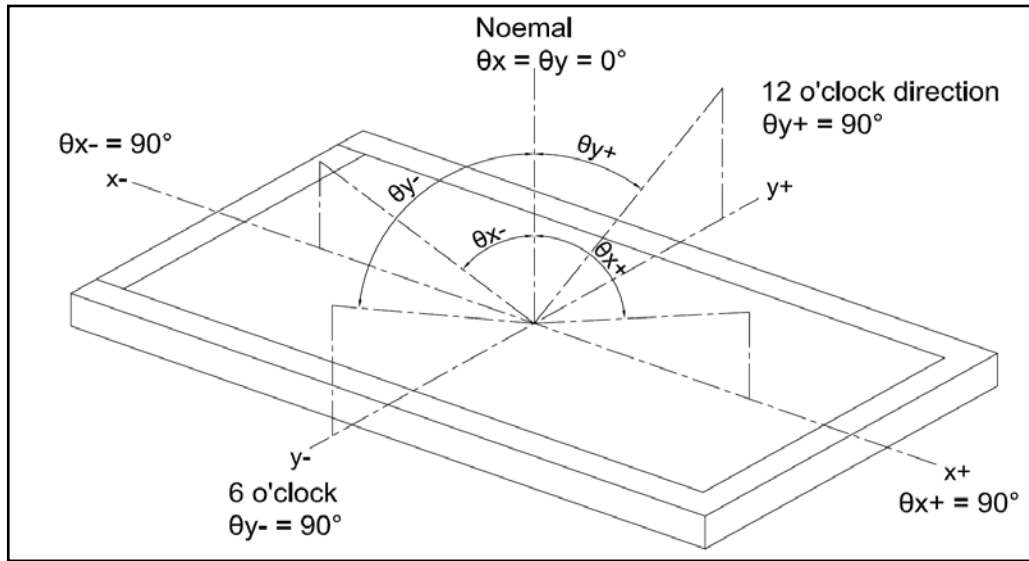

Note 4 : Measurement Set-Up:

The LCD module should be stabilized at a given temperature for 20 minutes to avoid abrupt temperature change during measuring. In order stabilize the luminance, the measurement should be executed after lighting Backlight for 20 minutes in a windless room.

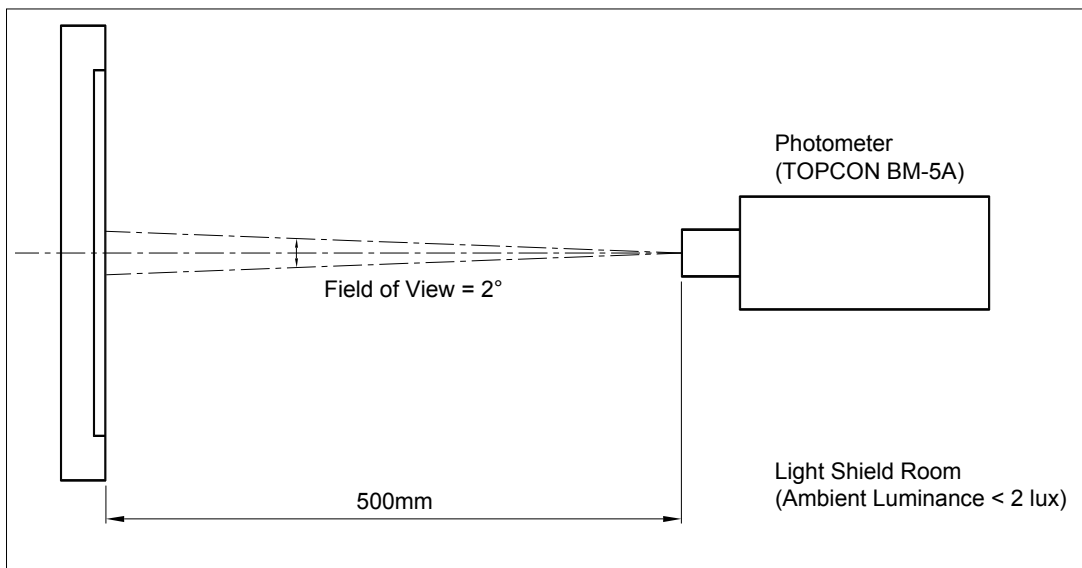

Note 5 :

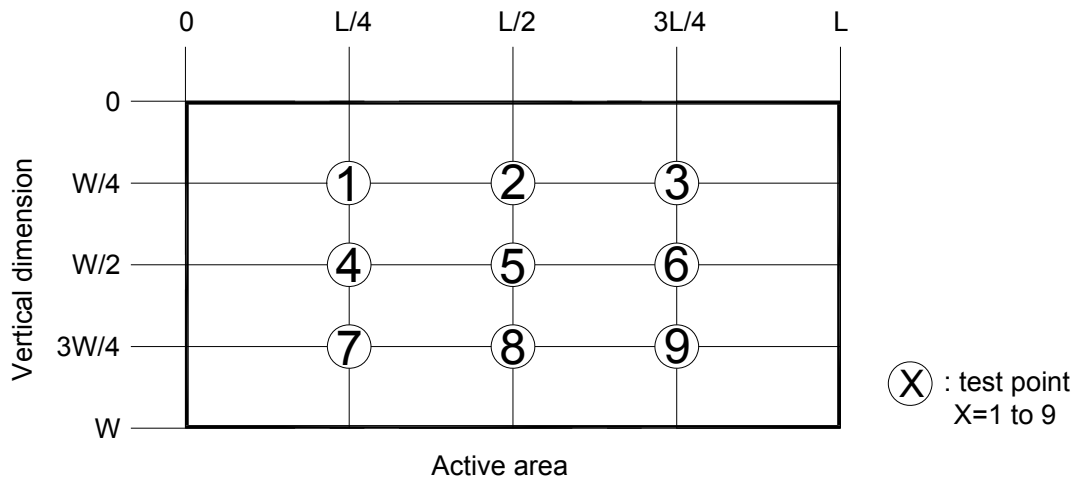

$$\left(1 - \frac{\text{MAX Luminance} - \text{Average Luminance}}{\text{Average Luminance}} \right) \times 100\% \geq 70\%$$

9. TIMING SPECIFICATIONS

9.1 POWER SIGNAL SEQUENCE

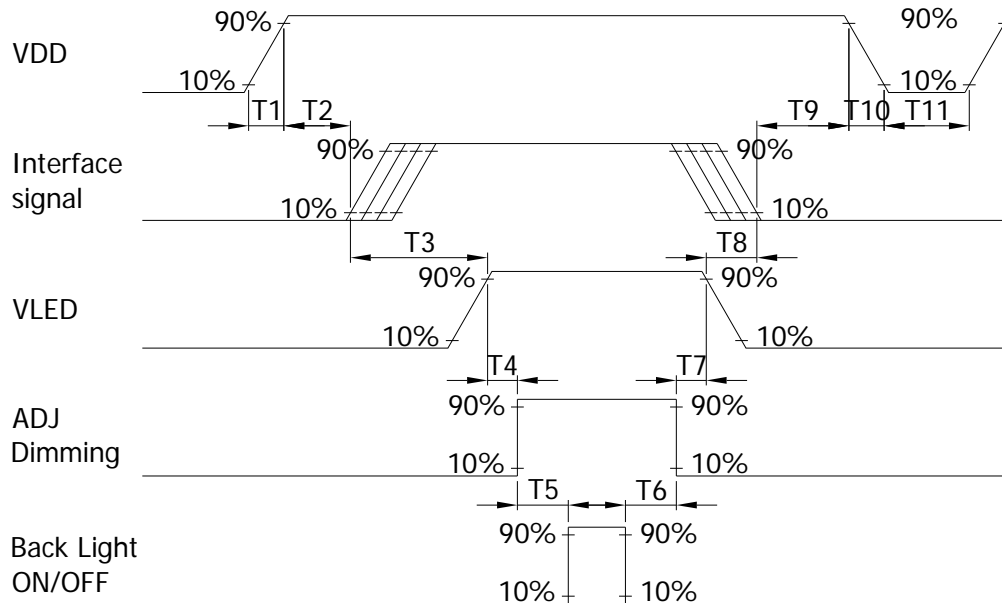

9.2 POWER ON/OFF SEQUENCE TIMING

ITEM	SYMBOL	MIN.	TYP.	MAX.	UNIT	REMARK
T1	-	0.5	-	10	ms	
T2	-	0	-	50	ms	
T3	-	200	-	-	ms	
T4	-	10	-	-	ms	
T5	-	10	-	-	ms	
T6	-	0	-	-	ms	
T7	-	10	-	-	ms	
T8	-	100	-	-	ms	
T9	-	0	16	50	ms	
T10	-	-	-	10	ms	
T11	-	1000	-	-	ms	

The above on/off sequence should be applied to avoid abnormal function in the display. Please make sure to turn off the power when you plug the cable into the input connector or pull the cable out of the connector.

9.3 THE INPUT DATA FORMAT

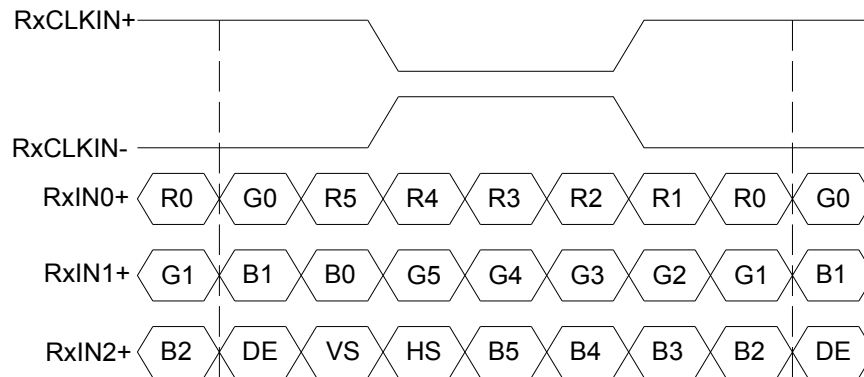

9.4 AC TIMING CHARACTERISTICS

ITEM		SYMBOL	MIN.	TYP.	MAX.	UNIT	REMARK
Clock	Frequency	1/Tc	31.95	33.26	34.6	MHz	Note1
	Clk Pulse Duty	Tcwh	40	50	60	%	Note1
	Clk Cycle Time	Tcph	25	-	-	ns	Note1
Data	Setup Time	Tdsu	5	-	-	ns	Note1
	Hold Time	Tdhd	5	-	-	ns	Note1
ENAB Signal	Setup Time	Tesu	5	-	-	ns	Note1
	Hold Time	Tehd	5	-	-	ns	Note1

Note1: Frame rate is 60Hz at 3.3V VDD

9.5 CLOCK AND DATA TIMING DIAGRAM

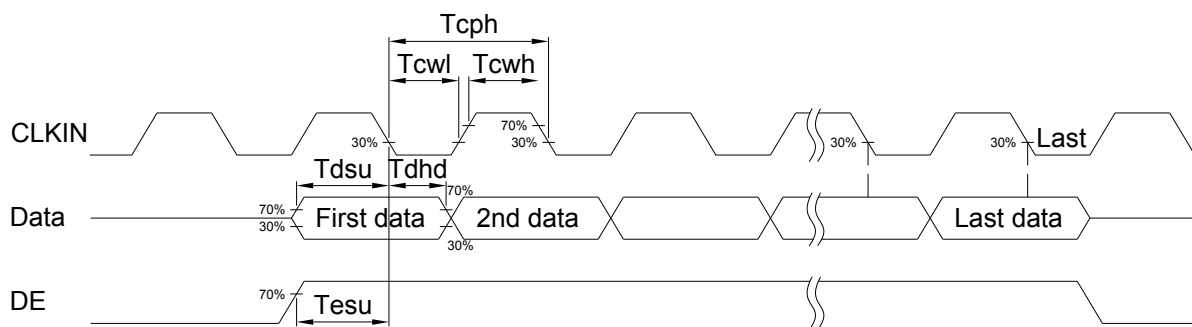

10. RELIABILITY TEST

ENVIRONMENTAL TEST				
NO.	ITEM	CONDITIONS	TIME PERIOD	REMARK
1	High Temperature Storage	85°C	240HRS	
2	Low Temperature Storage	-30°C	240HRS	
3	High Temperature Operation	85°C	240HRS	
4	Low Temperature Operation	-30°C	240HRS	
5	Temperature Cycle	-30°C~85°C	1HRS/ 10CYCLE	
6	High Temperature Humidity Storage	60°C 90%RH	240HRS	

NOTE 1 : a. The module should work properly.

b. Before and after function test, The difference of consumptive current. Should be within 10%.

NOTE 2 : a. The module should work properly.

b. The module won't be deformative, Color changeable or broken.

c. The modules can't be apart.

NOTE 3 : a. Before cosmetic and function test, The product must have enough recovery time, At least 2 hours at room temperature.

10.1 VIBRATION TEST :

11.1.1 STATE LABORATORY ENVIRONMENT :

Room temperature : $25\pm 3^{\circ}\text{C}$
Relative humidity : $55\pm 20\% \text{RH}$

11.1.2 TEST METHOD / SPECIFICATION :

Sample Status : Non-packaged single state
Waveform : Sine
Frequency : 10Hz~55Hz~10Hz
Full amplitude : 1.5mm
Vibration direction : X,Y,Z Axis (3 Axial)
Test time : Each 2Hour / X,Y,Z Axis , Altogether 6 Hour

10.2 MECHANICAL SHOCK TEST :

11.2.1 STATE LABORATORY ENVIRONMENT :

Room temperature : $25\pm 3^{\circ}\text{C}$
Relative humidity : $55\pm 20\% \text{RH}$

11.2.2 TEST METHOD / SPECIFICATION :

Sample Status : Non-packaged single state
Waveform : Half-sine
Acceleration : 100G
Shock Time : 6ms
Impact direction : 6 Directions ($\pm X, \pm Y, \pm Z$ axes)
Number of shocks : Each direction 3 Secondary , Altogether 18 Secondary

11.MODEL NUMBER SYSTEM

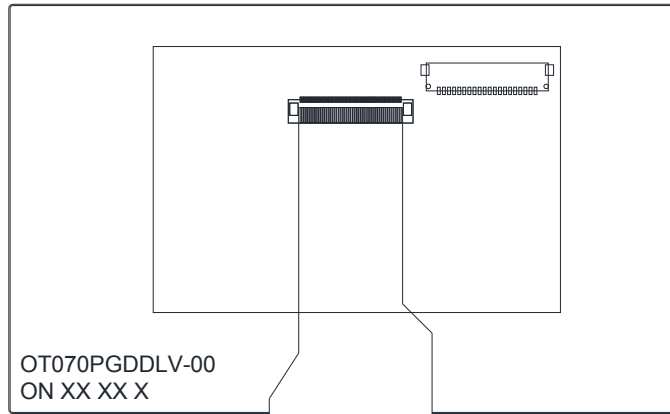

(a) MODEL NAME : OT070PGDDLX-00

(b) LOT NO : XX XX X

CODE	MEANING	DESCRIPTION
<u>XX</u>	Year	2013=13, 2014=14, 2015=15,
<u>XX</u>	Month	01,02,03,04,05,06,07,08,09,10,11,12
<u>X</u>	Week	1,2,3,4,5,6

12. LCM INSPECTION STANDARD

Inspection specifications refer ONation Corporation LCM INSPECTION STANDARD Document.
Document Number :QT3-QC-A-I002

13. PACKAGE INFORMATION

LCM MODEL	LCM QTY. IN THE BOX	INNER BOX SIZE (mm)	WEIGHT	REMARK
OT070PGDDLX-00	TBD	TBD	TBD	

14.PRECAUTIONS FOR USE

14.1 SAFETY

- (1) Do not swallow any liquid crystal, even if there is no proof that liquid crystal is poisonous.
- (2) If the LCD panel breaks, be careful not to get liquid crystal to touch your skin.
- (3) If skin is exposed to liquid crystal, wash the area thoroughly with alcohol or soap.

14.2 STORAGE CONDITIONS

- (1) Store the panel or module in a dark place where the temperature is $23\pm 5^{\circ}\text{C}$ and the humidity is below $50\pm 20\%\text{RH}$.
- (2) Store in anti-static electricity container.
- (3) Store in clean environment, free from dust, active gas, and solvent.
- (4) Do not place the module near organics solvents or corrosive gases.
- (5) Do not crush, shake, or jolt the module.

14.3 HANDLING PRECAUTIONS

- (1) Avoid static electricity which can damage the CMOS LSI.
- (2) The polarizing plate of the display is very fragile. So, please handle it very carefully.
- (3) Do not give external shock.
- (4) Do not apply excessive force on the surface.
- (5) Do not wipe the polarizing plate with a dry cloth, as it may easily scratch the Surface of plate.
- (6) Do not use ketonics solvent & Aromatic solvent, use with a soft cloth soaked with a cleaning naphtha solvent.
- (7) Do not operate it above the absolute maximum rating.
- (8) Do not remove the panel or frame from the module.
- (9) When the module is assembled, it should be attached to the system firmly, Be careful not to twist and bend the module.
- (10) Wipe off water droplets or oil immediately . If you leave the droplets for a long time, staining and discoloration may occur.
- (11) If the liquid crystal material leaks from the panel, it should be kept away from the eyes or mouth. In case of contact with hands, legs or clothes, it must be washed away thoroughly with soap.

14.4 WARRANTY

- (1) Acceptance inspection period
The period is within one month after the arrival of contracted commodity at the buyer's factory site.
- (2) Applicable warrant period
The period is within 12 months since the date of shipping out under normal using and storage conditions.