

TFT-DISPLAY DATASHEET

Sharp
Model: LQ084V1 DG43

BRIEF SPEC.:

Main Feature

Lamp Life

Lamp Replaceable

Landscape

Active Screen Area

170.88 x 127.16 (mm)

Diagonal | Format

8.4" | 4:3

Resolution

640 x 480

Colors

262K

Backlight

LED, White

Brightness

300 cd/m²

LED Life Time

70,000h (Typ.)

Interface

LVDS

Viewing Angle

65/65 L/R 60/55 U/D

Touchscreen

No

Power Supply

3,3V (Typ.)

Module Outline

221.0 x 152.4 x 9.8 (mm)

Operation Temperature

-10... +70 °C

Storage Temperature

-25... +70 °C

Surface Treatment

Anti-glare, Hard coating (3H)

PREPARED BY : DATE	 DISPLAY DEVICE BUSINESS GROUP SHARP CORPORATION SPECIFICATION	SPEC No. LD-24Y03A
APPROVED BY : DATE		FILE No.
		ISSUE : Nov. 19, 2012
		PAGE : 23 pages
		APPLICABLE GROUP
		DISPLAY DEVICE BUSINESS GROUP

DEVICE SPECIFICATION FOR
TFT-LCD Module
 MODEL No.
LQ084V1DG43

These parts have corresponded with the RoHS directive.

CUSTOMER' S APPROVAL

BY _____

BY *J. Kawanishi*
 J. Kawanishi
 General Manager
 DEVELOPMENT DEPT. I
 DISPLAY DEVICE DIVISION II
 DISPLAY DEVICE BUSINESS GROUP
 SHARP CORPORATION

1. Application

This specification applies to color TFT-LCD module, LQ084V1DG43

These specification sheets are the proprietary product of SHARP CORPORATION (SHARP) and include materials protected under copyright of SHARP. Do not reproduce or cause any third party to reproduce them in any form or by any means, electronic or mechanical, for any purpose, in whole or in part, without the express written permission of SHARP.

The device listed in these specification sheets was designed and manufactured for use in general electronic equipment.

In case of using the device for applications such as control and safety equipment for transportation (aircraft, trains, automobiles, etc.), rescue and security equipment and various safety related equipment which require higher reliability and safety, take into consideration that appropriate measures such as fail-safe functions and redundant system design should be taken.

Do not use the device for equipment that requires an extreme level of reliability, such as aerospace applications, telecommunication equipment (trunk lines), nuclear power control equipment and medical or other equipment for life support.

SHARP assumes no responsibility for any damage resulting from the use of the device which does not comply with the instructions and the precautions specified in these specification sheets.

Confirm "12. Handling Precautions " item when you use the device.

Contact and consult with a SHARP sales representative for any questions about this device.

2. Overview

This module is a color active matrix LCD module incorporating amorphous silicon TFT (Thin Film Transistor). It is composed of a color TFT-LCD panel, driver ICs, control circuit and power supply circuit and a backlight unit. Graphics and texts can be displayed on a 640×3×480 dots panel with 262,144 colors by supplying 18 bit data signal (6bit/color), four timing signals, +3.3V/5.0V DC supply voltage for TFT-LCD panel driving and supply voltage for backlight.

Viewing angle is 12 o'clock direction.

Backlight-driving LED controller is built in this module.

3. Mechanical Specifications

Parameter	Specifications	Unit
Display size	21 (8.4") Diagonal	cm
Active area	170.9 (H)×128.2 (V)	mm
Pixel format	640 (H)×480 (V)	pixel
	(1 pixel = R+G+B dots)	
Pixel pitch	0.267(H)×0.267 (V)	mm
Pixel configuration	R,G,B vertical stripe	
Display mode	Normally white	
Surface treatment	Anti-glare Hard coating 3H	

Parameter		Min.	Typ.	Max.	Unit
Unit outline dimensions [Note 3-1]	Width	220.5	221.0	221.5	mm
	Height	151.9	152.4	152.9	mm
	Depth	8.8	9.3	9.8	mm
Mass		—	—	340	g

[Note 3-1] Outline dimensions is shown in Fig.1

4. Input Terminals

4-1. TFT-LCD panel driving

CNI Used connector: DF9MA-31P-1V(32)
(Hirose Electric Co., Ltd.)

Corresponding connector: DF9-31S-1V(32)
(Hirose Electric Co., Ltd.)

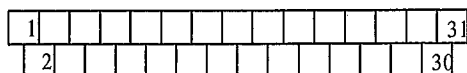

CNI pin arrangement from module surface
(Transparent view)

DF9A-31S-1V(22) (")
DF9B-31S-1V(32) (")
DF9C-31S-1V(22) (")
DF9M-31S-1V(32) (")

(※) Please do not use it besides corresponding connector

Pin No.	Symbol	Function	Remark
1	GND		
2	CK	Clock signal for sampling each data signal	
3	Hsync	Horizontal synchronous signal	【Note1】
4	Vsync	Vertical synchronous signal	【Note1】
5	GND		
6	R0	RED data signal(LSB)	
7	R1	RED data signal	
8	R2	RED data signal	
9	R3	RED data signal	
10	R4	RED data signal	
11	R5	RED data signal(MSB)	
12	GND		
13	G0	GREEN data signal(LSB)	
14	G1	GREEN data signal	
15	G2	GREEN data signal	
16	G3	GREEN data signal	
17	G4	GREEN data signal	
18	G5	GREEN data signal(MSB)	
19	GND		
20	B0	BLUE data signal(LSB)	
21	B1	BLUE data signal	
22	B2	BLUE data signal	
23	B3	BLUE data signal	
24	B4	BLUE data signal	
25	B5	BLUE data signal(MSB)	
26	GND		
27	ENAB	Signal to settle the horizontal display position	【Note2】
28	Vcc	+3.3/5.0V power supply	
29	Vcc	+3.3/5.0V power supply	
30	R/L	Horizontal display mode select signal	【Note3】
31	U/D	Vertical display mode select signal	【Note3】

※The shielding case is connected with GND.

【Note1】 480 line, 400 line or 350 line mode is selected by the polarity combination of the both synchronous signals.

Mode	480 lines	400 lines	350 lines
Hsync	Negative	Negative	Positive
Vsync	Negative	Positive	Negative

【Note2】 The horizontal display start timing is settled in accordance with a rising timing of ENAB signal.

In case ENAB is fixed "Low", the horizontal start timing is determined as described in 8-2.

Don't keep ENAB "High" during operation.

[Note 3]

R/L = High, U/D = High

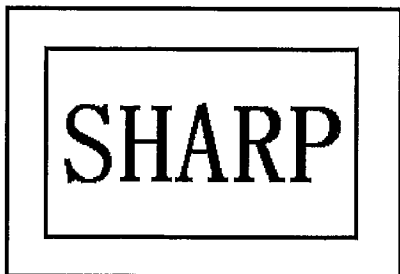

R/L = Low, U/D = High

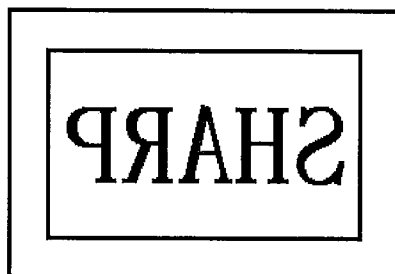

R/L = High, U/D = Low

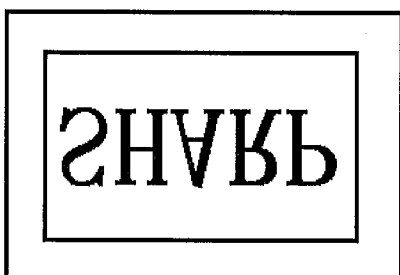

R/L = Low, U/D = Low

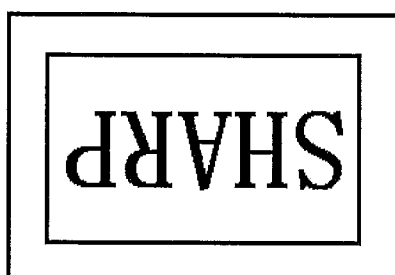

4-2. Backlight driving

CN2 Used connector : SM06B-SHLS-TF (J.S.T. Mfg. Co. Ltd)

Corresponding connector: SHLP-06V-S-B (J.S.T. Mfg. Co. Ltd)

Pin no.	Symbol	Function
1	VDD	Power supply for backlight
2	VDD	Power supply for backlight
3	GND	Ground for backlight
4	GND	Ground for backlight
5	BL-EN	ON/OFF control signal for backlight
6	PWM	PWM signal for backlight dimming

5. Absolute Maximum Ratings

Parameter	Symbol	Condition	MIN	MAX	Unit	Remark
Supply voltage	V _{CC}	Ta=25°C	0	+6.0	V	
	V _{DD}	Ta=25°C	0	+15.0	V	
Input voltage	V _{I1}	Ta=25°C	-0.3	V _{CC} +0.3	V	【Note 1】
	V _{I2}	Ta=25°C	-0.3	V _{DD}	V	【Note 2】
Storage temperature	T _{stg}	-	-25	+70	°C	【Note 4,5,6】
Operating temperature	T _{opp}	-	-10 (Ambient)	+70 (Panel surface)	°C	

【Note 1】 CK, R0 ~ R5, G0 ~ G5, B0 ~ B5, Hsync, Vsync, ENAB, R/L, U/D

【Note 2】 BL-EN, PWM

【Note 3】 Humidity: 95%RH Max. (at $T_a \leq 40^\circ\text{C}$)

Maximum wet-bulb temperature at 39°C or less (at $T_a > 40^\circ\text{C}$)

Dew condensation must be avoided as electrical current leaks will occur, causing a degradation of performance specifications.

【Note 4】 The operating temperature guarantees only operation of the circuit. For contrast, response time and other factors related to display quality, judgment is done using the ambient temperature $T_a = +25^\circ\text{C}$.

【Note 5】 Take care not to overrun ratings above.

6. Recommended operation condition

Parameter	Symbol	Min.	Typ.	Max.	Unit	Remark
Supply voltage	V_{CC}	+3.0	+3.3/+5.0	+5.5	V	[Note2]
Input voltage	V_I	0		V_{CC}	V	[Note1]
Temperature	T_{opa}	0		+70 (Panel surface)	$^\circ\text{C}$	[Note3]

[Note1] CK, R0~R5, G0~G5, B0~B5, Hsync, Vsync, ENAB, R/L, U/D

[Note2]

V_{CC}-turn-on conditions

$$0.3\text{ms} < t_1 \leq 15\text{ms}$$

$$0 < t_2 \leq 20\text{ms}$$

$$0 < t_3 \leq 1\text{s}$$

$$1\text{s} < t_4$$

$$1\text{s} < t_5$$

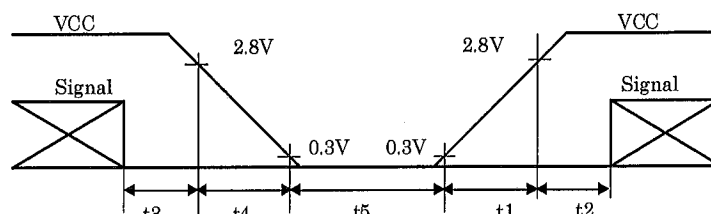

V_{CC}-dip conditions

$$1) \quad 2.5\text{V} \leq V_{CC} < 3.0\text{V}$$

$$t_d \leq 10\text{ms}$$

$$2) \quad V_{CC} < 2.7\text{V}$$

V_{CC}-dip conditions should also follow the

V_{CC}-turn-on conditions

[Note3]

Humidity: 95%RH Max. at $T_a \leq 40^\circ\text{C}$.

Maximum wet-bulb temperature at 39°C or less at $T_a > 40^\circ\text{C}$.

No condensation.

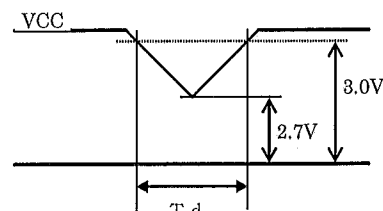

7. Electrical Characteristics

7-1. TFT-LCD panel driving

Ta=25 °C

Parameter	Symbol	Min.	Typ.	Max.	Unit	Remarks
Current dissipation	I _{cc}	-	240	340	mA	V _{cc} =3.3V [Note1]
		-	150	210	mA	V _{cc} =5.0V [Note1]
Allowed input ripple voltage	V _{RP}	-	-	100	mV p-p	V _{cc} =3.3V
Input voltage ("Low" state)	V _{IL}	0	-	0.8	V	[Note2]
Input voltage ("High" state)	V _{IH}	2.1	-	V _{cc}	V	
Input leakage current (low)	I _{OL1}	-	-	10	μA	V _I =0V [Note3]
	I _{OL2}	-800	-	-	μA	V _I =0V [Note4]
Input leakage current (High)	I _{OH}	-10	-	-	μA	V _I =3.3V [Note2]

[Note1] Typical current situation: 16-gray-bar pattern.

(480Line Mode, V_{cc}=+3.3V/+5.0V)

[Note2] CK, R0~R5, G0~G5, B0~B5, Hsync, Vsync, ENAB, R/L, U/D

[Note3] CK, R0~R5, G0~G5, B0~B5, Hsync, Vsync, ENAB,

[Note4] R/L, U/D

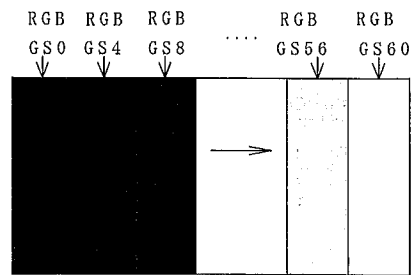

[Note5] See below block diagram of input interface.

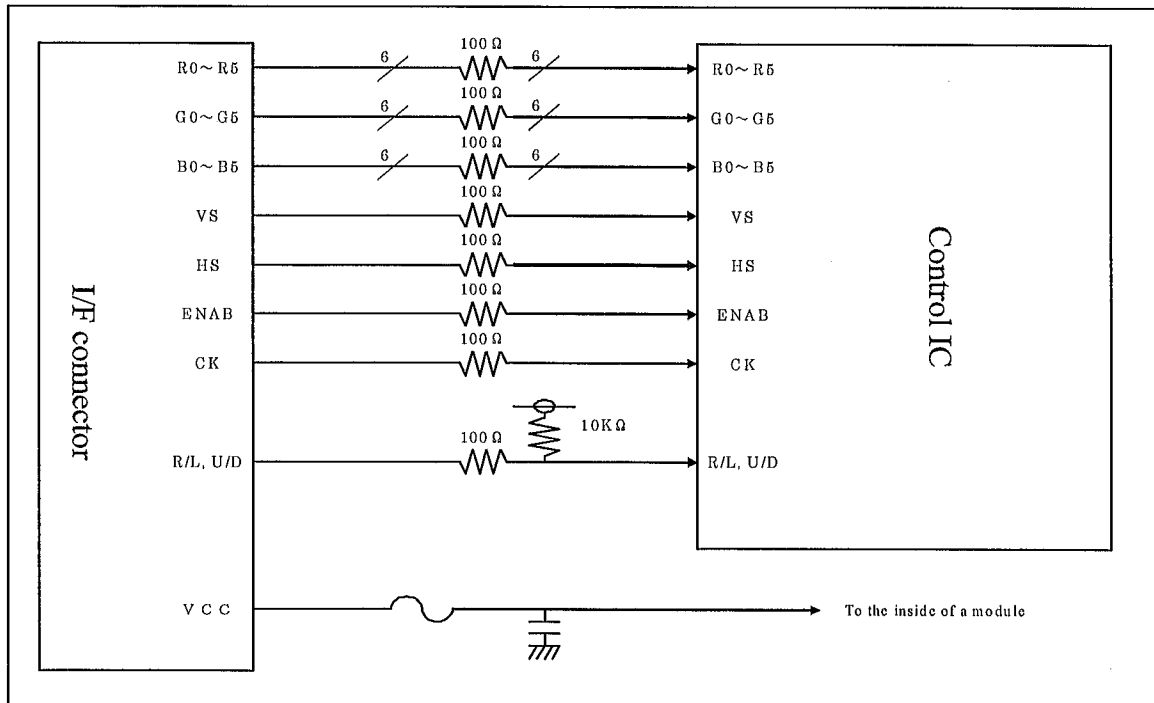

7-2. Backlight driving

It is usually required to measure under the following condition.

$T_a=25^{\circ}\text{C}\pm 2^{\circ}\text{C}$

Parameter	Symbol	Min.	Typ.	Max.	Unit	Remarks	
Supply voltage	V_{DD}	10.8	12.0	13.2	V	[Note1]	
Current dissipation	I_{DD}	-	320	380	mA	[Note2]	
Permissible input ripple voltage	V_{RP_BL}	-	-	200	mVp-p		
BL-EN	Input voltage (High)	V_{IH_BLEN}	2.1	-	5.5	V	[Note3]
	Input voltage (Low)	V_{IL_BLEN}	0	-	0.4	V	
	Input leakage current	I_{IL_BLEN}	-	-	1.0	mA	
PWM	Input voltage (High)	V_{IH_PWM}	2.1	-	5.5	V	[Note4]
	Input voltage (Low)	V_{IL_PWM}	0	-	0.4	V	
	Input leakage current	I_{IL_PWM}	-	-	1.0	mA	
PWM frequency	f_{PWM}	200	-	1,000	Hz	[Note5]	
PWM duty ratio	D_{PWM}	10	-	100	%		
Life time	L	-	70,000 (module)	-	h	Reference value [Note6]	

[Note1] On-off conditions for supply voltage.

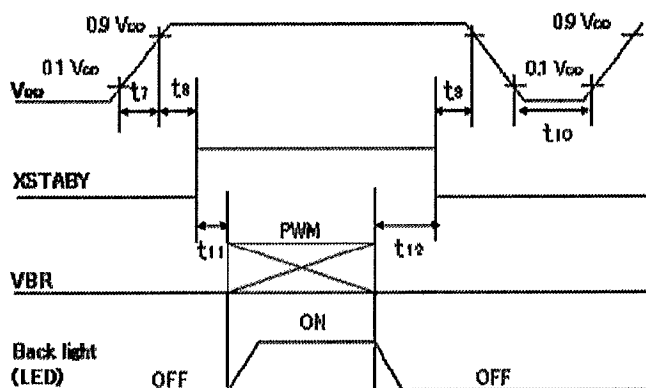

$$\begin{aligned}
 20\ \mu\text{s} &\leq t_7 \leq (200)\text{ms} \\
 0\text{ms} &\leq t_8 \leq (\text{TBD}) \\
 0\text{ms} &\leq t_9 \leq (\text{TBD}) \\
 (1)\text{s} &\leq t_{10} \\
 (100)\text{ms} &\leq t_{11} \leq (\text{TBD}) \\
 0\text{ms} &\leq t_{12} \leq (\text{TBD})
 \end{aligned}$$

[Note2] Current dissipation

Typ. value : $V_{DD}=+12.0\text{V}$, Duty=100%

Max. value : $V_{DD}=+10.8\text{V}$, Duty=100%

[Note3] BL-EN is connected by the pull-up resistor.

[Note4] PWM is connected by the pull-up resistor.

[Note5] PWM

$$f_{PWM} = 1/t_{14}$$

Duty 10% : Min. Luminance

Duty 100% : Max. Luminance

Luminance changes in proportion to the duty ratio. ($t_{13} \geq 500\ \mu\text{s}$)

When the frequency slows, the display fineness might decrease.

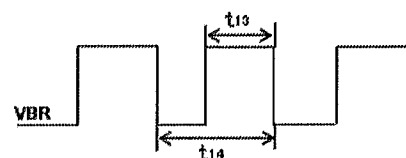

[Note6] Luminance becomes 50% of an initial value. ($T_a=25^{\circ}\text{C}$, PWM=100%)

[Note7] When PWM signal is set "LOW" more than 10ms, please turn off V_{DD} .

If PWM signal is input without reset of V_{DD} , Softstart function of LED driving circuit is invalid and inrush current may occur.

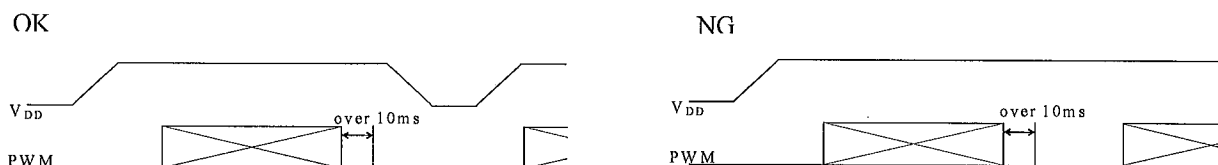

8. Timing Characteristics of input signals

Timing diagrams of input signal are shown in Fig.2.

8-1. Timing characteristics

Parameter		Symbol	Min.	Typ.	Max.	Unit	Remark
Clock	Frequency	1/Tc	-	25.18	28.33	MHz	-
	High time	Tch	5	-	-	ns	-
	Low time	Tcl	10	-	-	ns	-
	Duty ratio	Th/T	40	50	60	%	-
Data	Setup time	Tds	5	-	-	ns	-
	Hold time	Tdh	10	-	-	ns	-
Horizontal sync. signal	Cycle	TH	30.00	31.78	-	μ s	-
			750	800	900	clock	-
	Pulse width	THp	2	96	200	clock	-
Vertical sync. signal	Cycle	TV	515	525	560	line	480line mode
			446	449	480	line	400line mode
			447	449	510	line	350line mode
	Pulse width	TVp	1	-	34	line	-
Horizontal display period		THd	640	640	640	clock	-
Hsync-Clock phase difference		THc	10	-	Tc-10	ns	-
Hsync-Vsync phase difference		TVh	0	-	TH-THp	clock	-

[Note] In case of lower frequency, the deterioration of display quality, flicker etc., may be occurred.

8-2. Horizontal display position

The horizontal display position is determined by ENAB signal and the input data corresponding to the rising edge of ENAB signal is displayed at the left end of the active area.

Parameter		symbol	Min.	Typ.	Max.	Unit	Remark
Enable signal	Setup time	Tes	5	-	Tc-10	ns	-
	Pulse width	Tep	2	640	640	clock	-
Hsync-Enable signal phase difference		THE	44	-	TH-664	clock	-

[Note] When ENAB is fixed "Low", the display starts from the data of C104(clock) as shown in Fig.2-①~③.

When the phase difference is below 104 clocks, keep the "High" level of ENAB signal longer than 104-THE clocks. If it will not be kept, the display starts from the data of C104 (clock).

Be careful that the module does not work when ENAB is fixed "High".

8-3. Vertical display position

The vertical display position is automatically centered in the active area at each mode of VGA, 480-, 400-, and 350-line mode. Each mode is selected depending on the polarity of the synchronous signals described in 4-1 (Note1).

In each mode, the data of TVn is displayed at the top line of the active area. And the display position will be centered on the screen like the following figure when the period of vertical synchronous signal (TV) is typical value.

In 400-, and 350-line mode, the data in the vertical data invalid period is also displayed, so, inputting all data "0" is recommended during vertical data invalid period. ENAB signal has no relation to the vertical display position.

Mode	V-data start (TVs)	V-data period (TVd)	V-display start (TVn)	V-display period	Unit	Remark
480	34	480	34	480	line	-
400	34	400	443-TV	480	line	-
350	61	350	445-TV	480	line	-

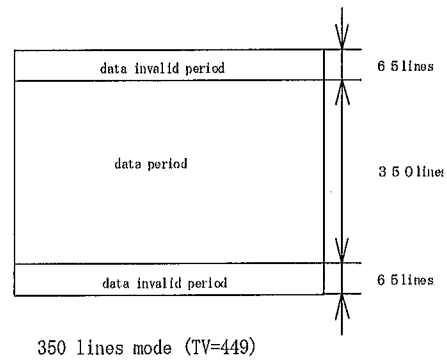
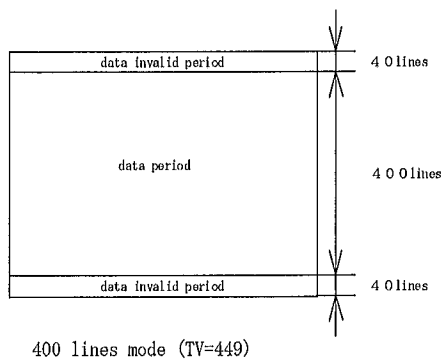

8-4. Input Data Signals and Display Position on the screen

Display position of input data (480 line mode)
(H, V)

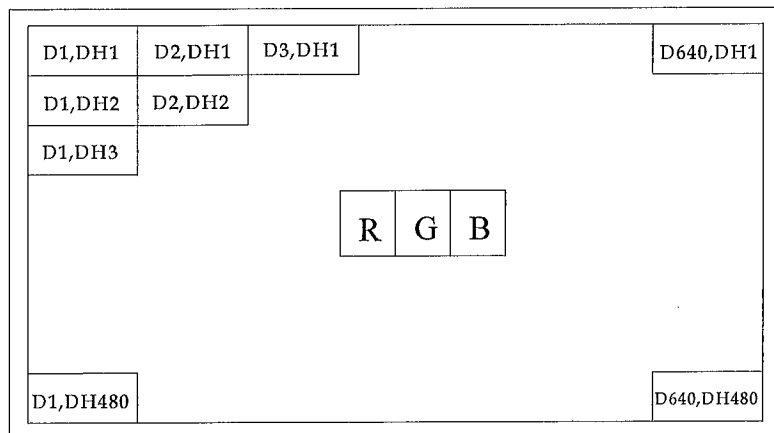

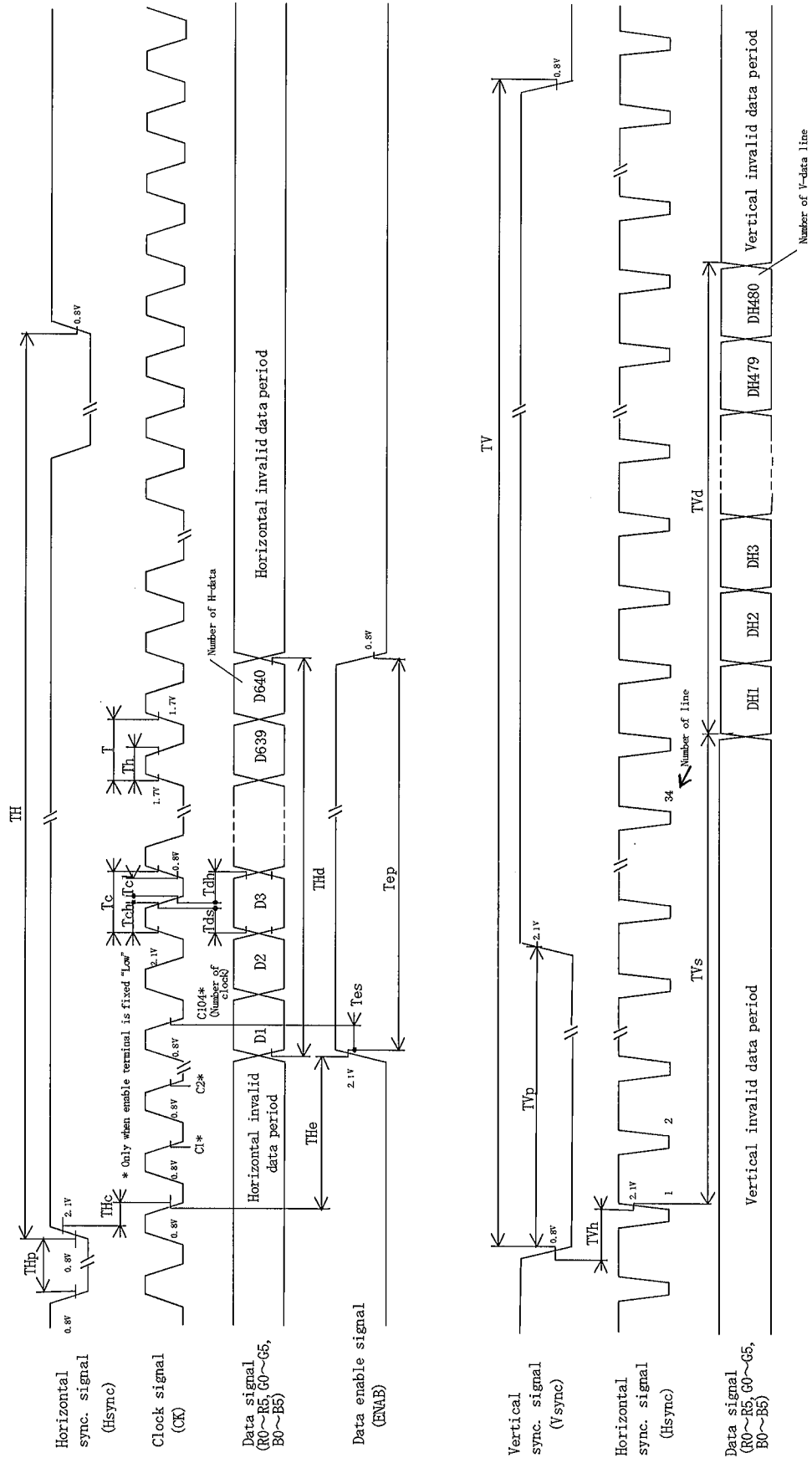

Fig 2-① Input signal waveforms (480 line mode)

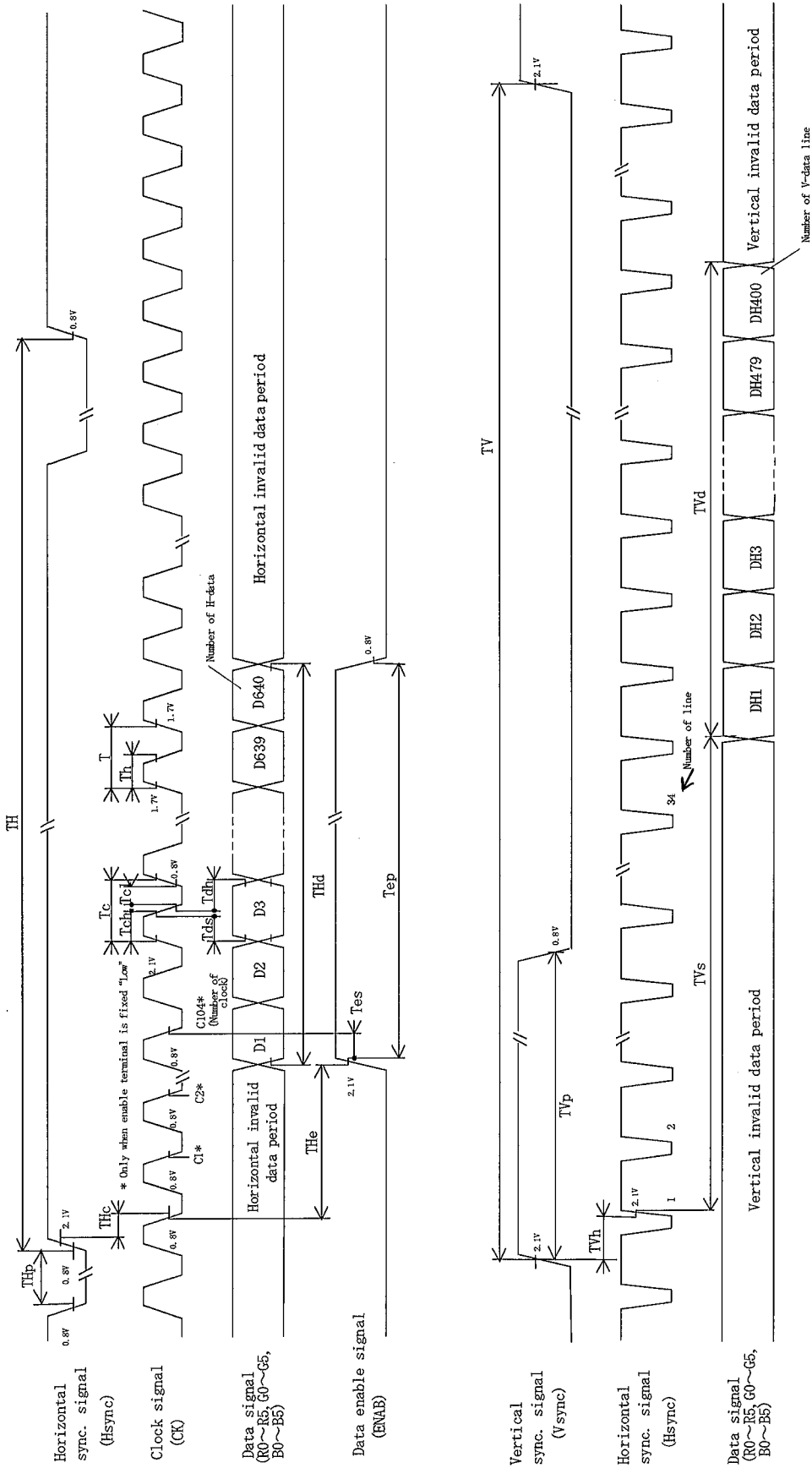

Fig2-② Input signal waveforms (400 line mode)

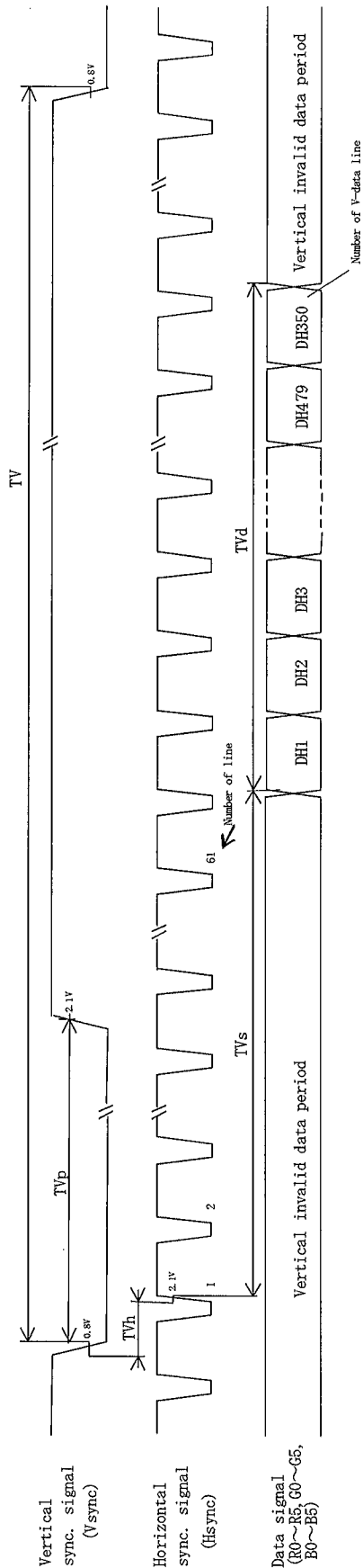
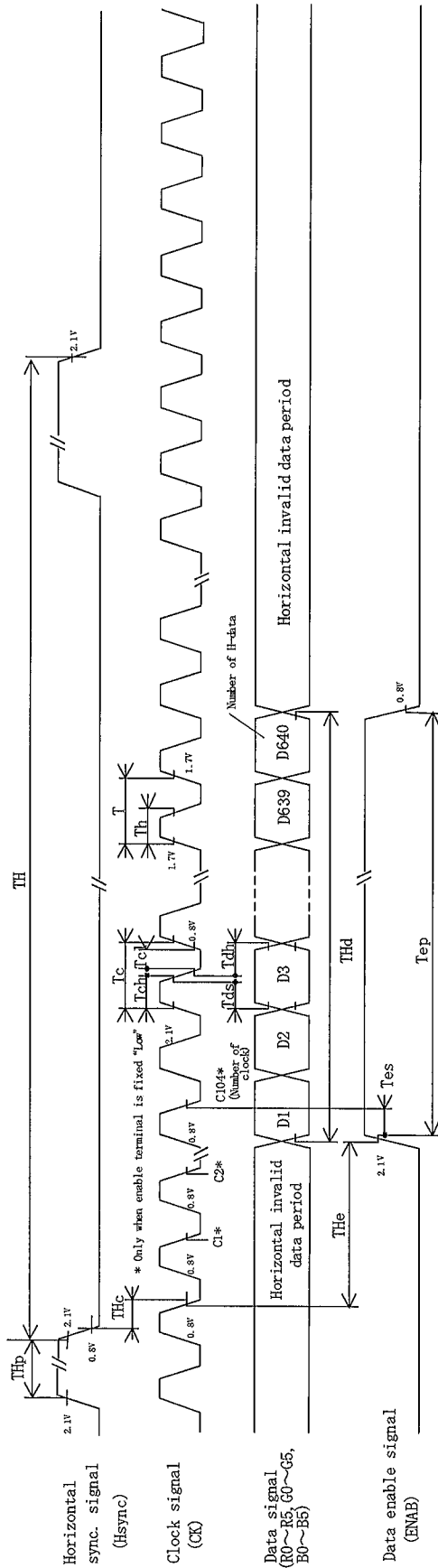

Fig 2-3 Input signal waveforms (350 line mode)

9. Input Signals, Basic Display Colors and Gray Scale of Each Color

	Colors &	Data signal																		
	Gray scale	Gray Scale	R0	R1	R2	R3	R4	R5	G0	G1	G2	G3	G4	G5	B0	B1	B2	B3	B4	B5
Basic Color	Black	—	0	0	0	0	0	0	0	0	0	0	0	0	0	0	0	0	0	0
	Blue	—	0	0	0	0	0	0	0	0	0	0	0	0	1	1	1	1	1	1
	Green	—	0	0	0	0	0	0	1	1	1	1	1	1	0	0	0	0	0	0
	Cyan	—	0	0	0	0	0	0	1	1	1	1	1	1	1	1	1	1	1	1
	Red	—	1	1	1	1	1	1	0	0	0	0	0	0	0	0	0	0	0	0
	Magenta	—	1	1	1	1	1	1	0	0	0	0	0	0	1	1	1	1	1	1
	Yellow	—	1	1	1	1	1	1	1	1	1	1	1	1	0	0	0	0	0	0
	White	—	1	1	1	1	1	1	1	1	1	1	1	1	1	1	1	1	1	1
Gray Scale of Red	Black	GS0	0	0	0	0	0	0	0	0	0	0	0	0	0	0	0	0	0	0
	↑	GS1	1	0	0	0	0	0	0	0	0	0	0	0	0	0	0	0	0	0
	Darker	GS2	0	1	0	0	0	0	0	0	0	0	0	0	0	0	0	0	0	0
	↑	↓			↓					↓					↓					
	↓	↓			↓					↓					↓					
	Brighter	GS61	1	0	1	1	1	1	0	0	0	0	0	0	0	0	0	0	0	0
	↓	GS62	0	1	1	1	1	1	0	0	0	0	0	0	0	0	0	0	0	0
	Red	GS63	1	1	1	1	1	1	0	0	0	0	0	0	0	0	0	0	0	0
Gray Scale of Green	Black	GS0	0	0	0	0	0	0	0	0	0	0	0	0	0	0	0	0	0	0
	↑	GS1	0	0	0	0	0	0	1	0	0	0	0	0	0	0	0	0	0	0
	Darker	GS2	0	0	0	0	0	0	0	1	0	0	0	0	0	0	0	0	0	0
	↑	↓			↓					↓					↓					
	↓	↓			↓					↓					↓					
	Brighter	GS61	0	0	0	0	0	0	1	0	1	1	1	1	0	0	0	0	0	0
	↓	GS62	0	0	0	0	0	0	0	1	1	1	1	1	0	0	0	0	0	0
	Green	GS63	0	0	0	0	0	0	1	1	1	1	1	1	0	0	0	0	0	0
Gray Scale of Blue	Black	GS0	0	0	0	0	0	0	0	0	0	0	0	0	0	0	0	0	0	0
	↑	GS1	0	0	0	0	0	0	0	0	0	0	0	0	1	0	0	0	0	0
	Darker	GS2	0	0	0	0	0	0	0	0	0	0	0	0	0	1	0	0	0	0
	↑	↓			↓					↓					↓					
	↓	↓			↓					↓					↓					
	Brighter	GS61	0	0	0	0	0	0	0	0	0	0	0	0	1	0	1	1	1	1
	↓	GS62	0	0	0	0	0	0	0	0	0	0	0	0	0	1	1	1	1	1
	Blue	GS63	0	0	0	0	0	0	0	0	0	0	0	0	1	1	1	1	1	1

0 : Low level voltage, 1 : High level voltage

Each basic color can be displayed in 64 gray scales from 6 bit data signals. According to the combination of total 18 bit data signals, the 262,144-color display can be achieved on the screen.

10. Optical Characteristics

Ta=25°C, Vcc=+3.3V / +5.0V

Parameter		Symbol	Condition	Min.	Typ.	Max.	Unit	Remark
Viewing angle range	Horizontal	$\theta 21, \theta 22$	CR>10	55	70	-	Deg.	[Note1]
	Vertical	$\theta 11$		50	60	-	Deg.	[Note4]
		$\theta 12$		40	50	-	Deg.	[Note4]
Contrast ratio		CR	Optimum viewing angle	-	600	-		[Note2] [Note4]
Response time	Rise	τr	$\theta = 0^\circ$	-	10	-	ms	[Note3]
	Decay	τd		-	25	-	ms	[Note4]
Chromaticity of white		x		0.255	0.305	0.355		[Note4]
		y		0.280	0.330	0.380		
Luminance of white		Y_L		240	300	-	cd/m ²	
White Uniformity		δW		-	-	1.45		[Note5]
Viewing Angle		-	-	12			o'clock	[Note6]

[Note] The measurement shall be executed 30 minutes after lighting at rating.

The optical characteristics shall be measured in a dark room or equivalent state with the method shown in Fig.3 below. (condition: PWM Duty=100%)

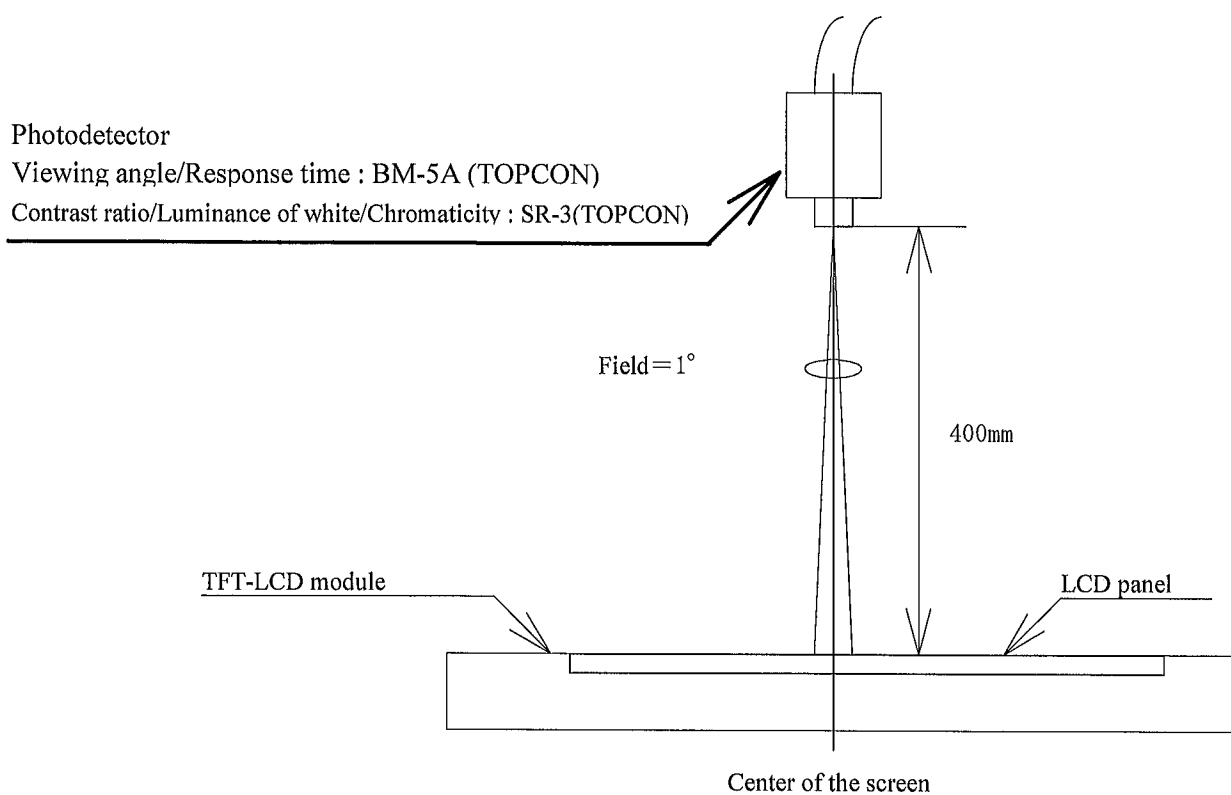
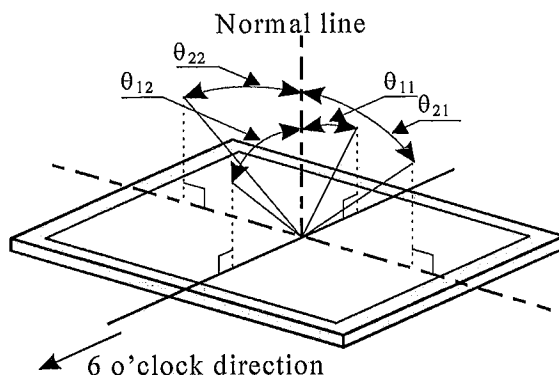

Fig.3 Optical characteristics measurement method

[Note1] Definitions of viewing angle range:



[Note2] Definition of contrast ratio:

The contrast ratio is defined as the following.

$$\text{Contrast Ratio (CR)} = \frac{\text{Luminance (brightness) with all pixels white}}{\text{Luminance (brightness) with all pixels black}}$$

[Note3] Definition of response time:

The response time is defined as the following figure and shall be measured by switching the input signal for "black" and "white".

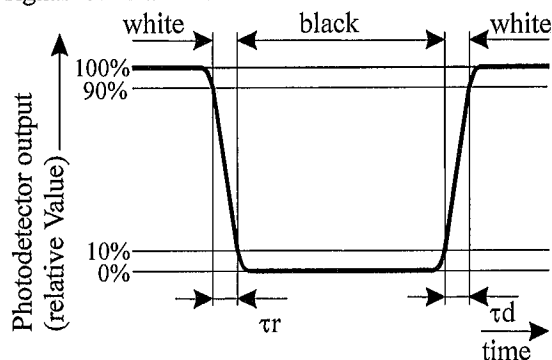

[Note4] This shall be measured at center of the screen.

[Note5] Definition of white uniformity:

White uniformity is defined as the following with five measurements (A~E).

$$\delta_w = \frac{\text{Maximum Luminance of five points (brightness)}}{\text{Minimum Luminance of five points (brightness)}}$$

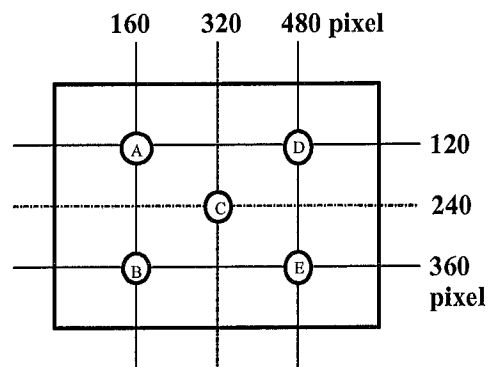

[Note6] The optimum viewing angle of this module (θ_{max}) is slightly leaned to 12 o'clock from normal line.

Where $\theta_{11} > \theta_{max}$, gray scale is reversed partially.

Where $\theta_{11} < \theta_{max}$, or 6 o'clock direction, gray scale isn't reversed.

11. Display Quality

The display quality of the color TFT-LCD module shall be in compliance with the Incoming Inspection Standard.

12. Handling Precautions

- a) Be sure to turn off the power supply when inserting or disconnecting the cable.
- b) Be sure to design the cabinet so that the module can be installed without any extra stress such as warp or twist.
- c) Since the front polarizer is easily damaged, pay attention not to scratch it.
- d) Wipe off water drop immediately. Long contact with water may cause discoloration or spots.
- e) When the panel surface is soiled, wipe it with absorbent cotton or other soft cloth.
- f) Since the panel is made of glass, it may break or crack if dropped or bumped on hard surface. Handle with care.
- g) Since CMOS LSI is used in this module, take care of static electricity and injure the human earth when handling.

Observe all other precautionary requirements in handling components.

- h) Since there is a circuit board in the module back, stress is not added at the time of a design assembly. Please make it like. If stress is added, there is a possibility that circuit parts may be damaged.
- i) Protection film is attached to the module surface to prevent it from being scratched.
Peel the film off slowly, just before the use, with strict attention to electrostatic charges.
Blow off 'dust' on the polarizer by using ionized nitrogen.
- j) The polarizer surface on the panel is treated with Anti-Glare for low reflection. In case of attaching protective board over the LCD, be careful about the optical interface fringe etc. which degrades display quality.
- k) Do not expose the LCD panel to direct sunlight. Lightproof shade etc. should be attached when LCD panel is used under such environment.
- l) Connect GND to 4 place of mounting holes to stabilize against EMI and external noise.
- m) There are high voltage portions on the backlight. It is very dangerous to touch carelessly.
It may lead to electrical shock. When exchanging lamps or getting service, turn off the power without fail.
- n) When handling LCD modules and assembling them into cabinets, please be avoid that long-term storage in the environment of oxidization or deoxidization gas and the use of such materials as reagent, solvent, adhesive, resin, etc. which generate these gasses, may cause corrosion and discoloration of the LCD modules.
- o) Cold cathode fluorescent lamp in LCD panel contains a small amount of mercury, please follow local ordinances or regulations for disposal.
- p) Be careful of a back light lead not to pull by force at the time of the wiring to an inverter, or line processing.
- q) When install LCD modules in the cabinet, please tighten with “torque= $0.294 \pm 0.02\text{N} \cdot \text{m}$ ($3.0 \pm 0.2\text{kgf} \cdot \text{cm}$)”.
Be sure to confirm it in the same condition as it is installed in your instrument.
- r) Liquid crystal contained in the panel may leak if the LCD is broken. Rinse it as soon as possible if it gets inside your eye or mouth by mistake.
- s) Notice: Never dismantle the module, because it will cause failure.
Please don't remove the fixed tape, insulating tape etc. that was pasted on the original module.
(Except for protection film of the panel and the crepe tape (yellow tape) of fixing lamp cable temporarily.)
- t) Be careful when using it for long time with fixed pattern display as it may cause afterimage.
(Please use a screen saver etc., in order to avoid an afterimage.)
- u) Adjusting volume has been set optimally before shipment, so do not change any adjusted value.
If adjusted value is changed, the specification may not be satisfied.
- v) If a minute particle enters in the module and adheres to an optical material, it may cause display non-uniformity issue, etc. Therefore, fine-pitch filters have to be installed to cooling and inhalation hole if you intend to install a fan.
- w) The lamp used for this product is very sensitive to the temperature.
Luminance decreases rapidly when it is used for a long time or repeatedly under the environment of the low

temperature or the module is being cooled.

Please avoid the continuous or repeating use of it under such an environment.

It may decrease up to 50% of the initial luminance in about one month under the low temperature environment.

Please consult our company when it is used under the environment like the above mentioned.

13. Packing form

Piling number of cartons	Max.8
Package quantity in one carton	20pcs
Carton size(mm)	524(W)×411(D)×233(H)
Total mass of one carton filled with full modules	10kg

14. Reliability test items

No.	Test item	Conditions	Remark
1	High temperature storage test	Ta=70°C 240h	
2	Low temperature storage test	Ta= -25°C 240h	
3	High temperature & high humidity operation test	Ta=40°C ; 95%RH 240h (No condensation)	
4	High temperature operation test	Ta=70°C (Panel surface) 240h	
5	Low temperature operation test	Ta= -10°C 240h	
6	Vibration test (non- operating)	Frequency: 10~57Hz/Vibration width (one side) : 0.076mm : 57~500Hz/Gravity : 9.8m/s ² Sweep time : 11 minutes Test period : 3 hours (1 hour for each direction of X,Y,Z)	
7	Shock test (non- operating)	Max. gravity : 490m/s ² Pulse width : 11ms, half sine wave Direction : ±X, ±Y, ±Z once for each direction.	
8	ESD test	Contact discharge (150pF 330Ω) non-operating = ±10kV, operating = ±8kV Atmospheric discharge (150pF 330Ω) non-operating = ±20kV, operating = ±15kV	
9	EMI	Measurement in 10m site Display position on the screen = "H" (full-screen), GND to 4 place = un-connect, Vcc / Vsignal = typ.	VCCI (Class B)

[Result Evaluation Criteria]

Under the display quality test conditions with normal operation state, these shall be no change which may affect practical display function.

(normal operation state : Temperature:15~35°C, Humidity:45~75%, Atmospheric pressure:86~106kpa)

15. Others

15-1 Lot No. Label:

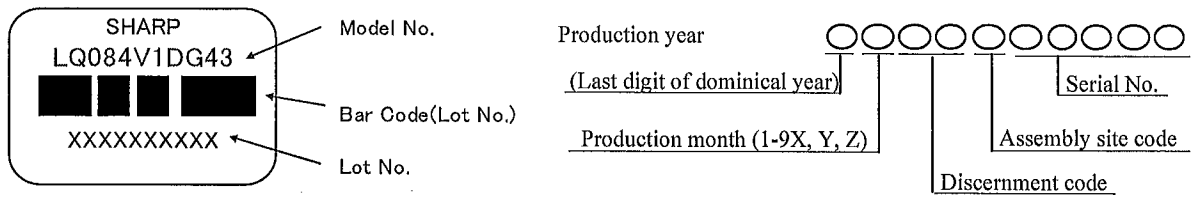

15-2 Packing box Label:

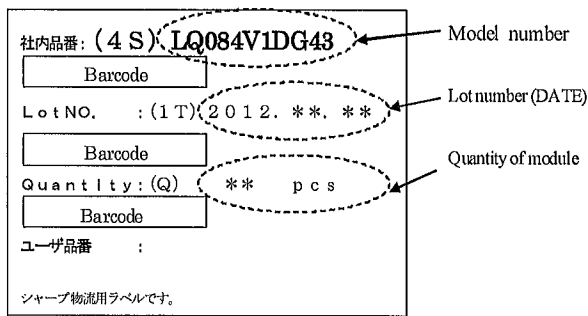

Internal Use Only
R. C.

※R.C. (RoHS Compliance) means these parts have corresponded with the RoHS directive.

15-3 If any problem occurs in relation to the description of this specification , it shall be resolved through discussion with spirit of cooperation.

16. Carton storage condition

Temperature	0°C to 40°C
Humidity	95%RH or less
Reference condition :	20°C to 35°C , 85%RH or less (summer) : 5°C to 15°C , 85%RH or less (winter) • the total storage time (40°C,95%RH) : 240H or less
Sunlight	Be sure to shelter a product from the direct sunlight.
Atmosphere	Harmful gas, such as acid and alkali which bites electronic components and/or wires must not be detected.
Notes	Be sure to put cartons on palette or base, don't put it on floor, and store them with removing from wall Please take care of ventilation in storehouse and around cartons, and control changing temperature is within limits of natural environment
Storage period	1 year

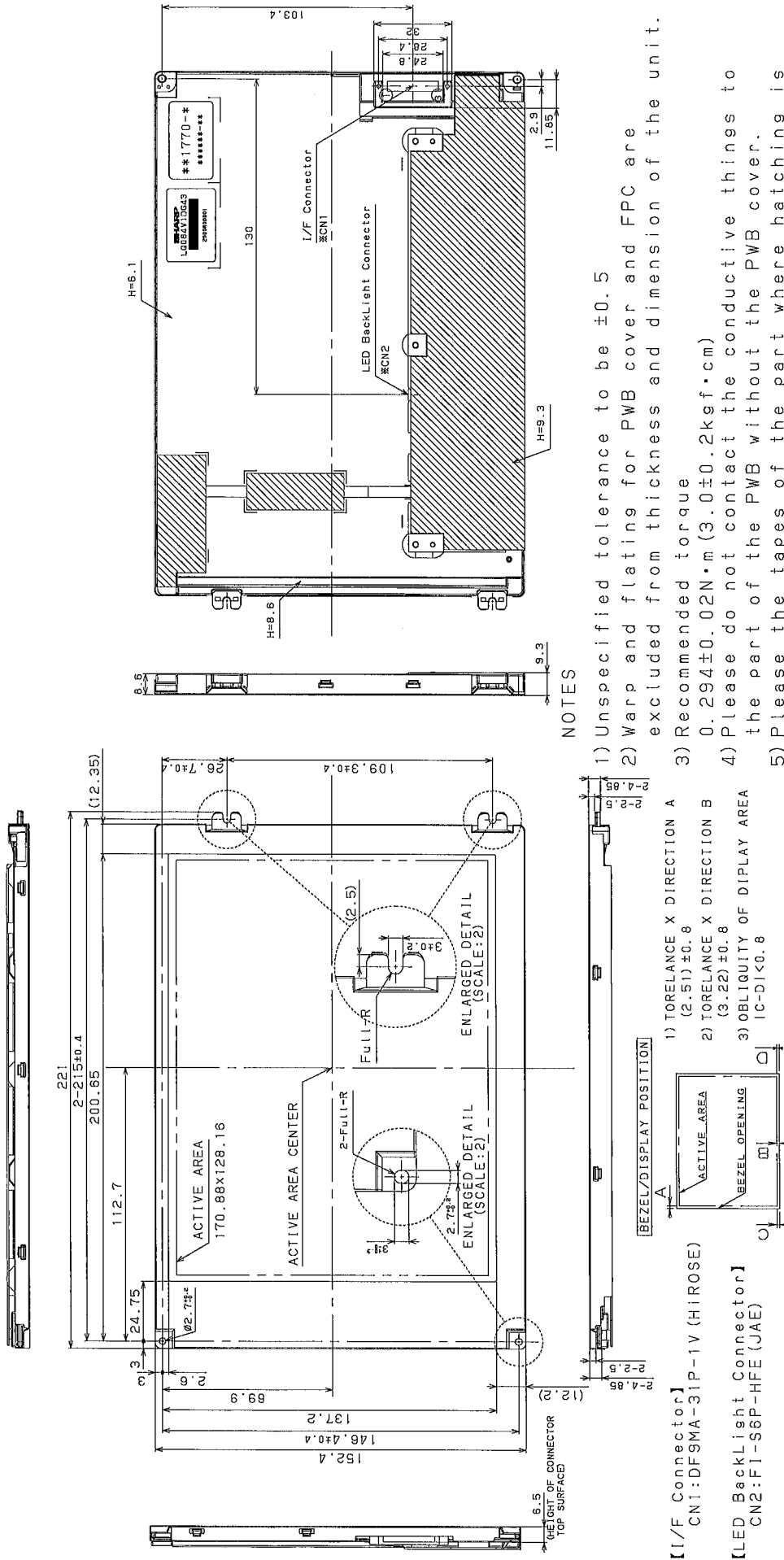

Fig.1 : LQ084VIDG43 OUTLINE DIMENSIONS

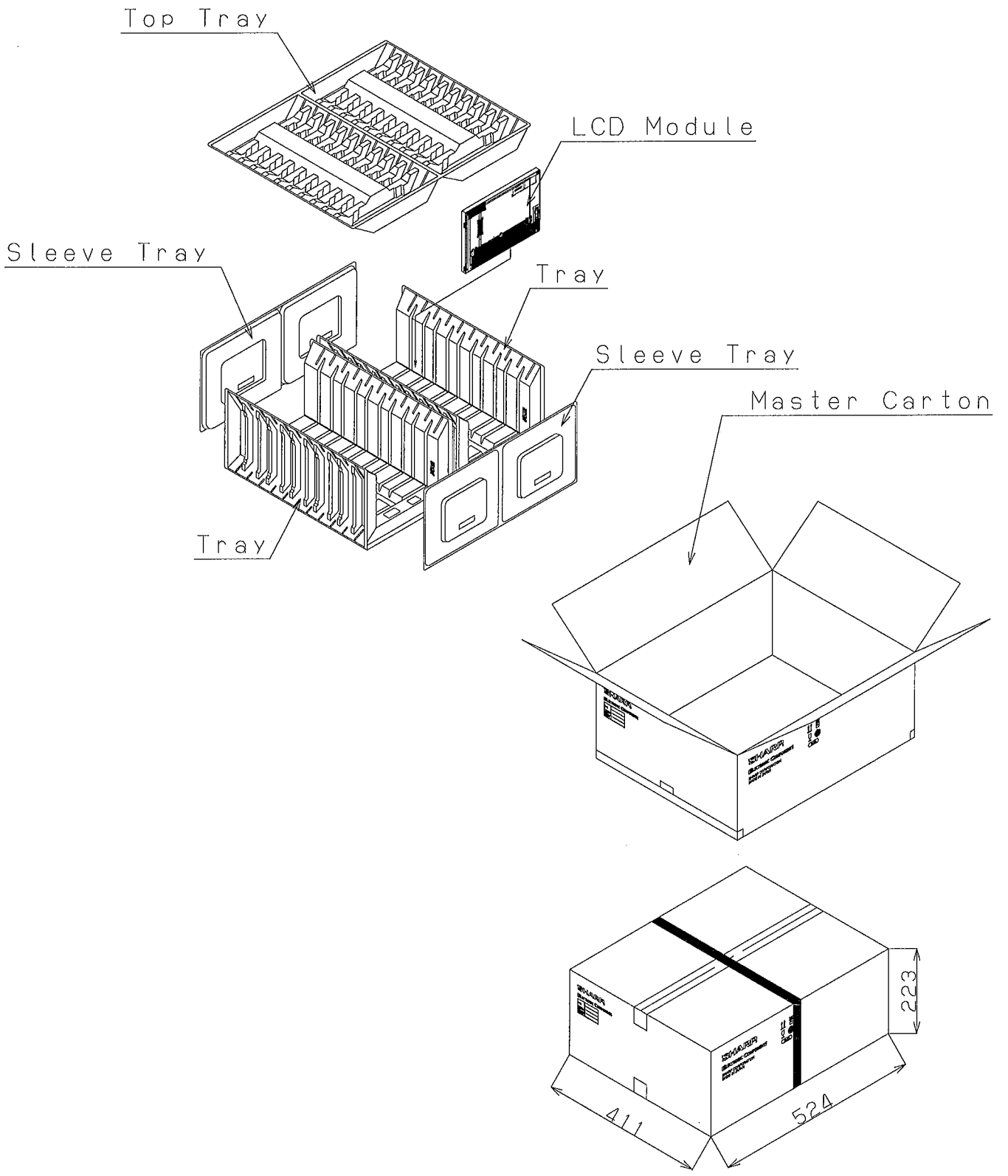

Fig. 3 : PACKING FORM