

TFT-DISPLAY DATASHEET

Sharp
Model: LQ121S1DG81

BRIEF SPEC.:

Main Feature	Landscape With LED Backlight Long Lamp Life
Active Screen Area	246.0x 184.5 (mm)
Diagonal Format	12.1" 4:3
Resolution	800 X 600
Colors	262k (1ch 6 Bit)
Backlight	LED, Withe
Brightness	450 cd/m ²
LED Life Time	70,000h (Typ.)
Interface	TTL
Viewing Angle	80/80 L/R 60/80
Touchscreen	No
Power Supply	3,3V (Typ.)
Module Outline	276.0 x 209.0 x 11 (mm)
Operation Temperature	-30... +80 °C
Storage Temperature	-30... +80 °C
Surface Treatment	Anti Glare Hard Coating (3H)

PREPARED BY : DATE	SHARP DISPLAY DEVICE BUSINESS GROUP SHARP CORPORATION SPECIFICATION	SPEC No. LD-24X03C
APPROVED BY : DATE		FILE No. LD-24X03C
		ISSUE : 25-Oct-12
		PAGE : 23pages
		APPLICABLE GROUP DISPLAY DEVICE BUSINESS GROUP

REVISION : 12-Jul-13

DEVICE SPECIFICATION FOR
TFT-LCD Module
 MODEL No.
LQ121S1DG81

These parts have corresponded with the RoHS directive.

CUSTOMER'S APPROVAL

BY _____

BY *T. Ohnishi*
 T. Ohnishi
 GENERAL MANAGER
 DEVELOPMENT DEPARTMENT III
 DISPLAY DEVICE DIVISION III
 DISPLAY DEVICE BUSINESS GROUP
 SHARP CORPORATION

RECORDS OF REVISION

MODEL No. LQ121S1DG81

SPEC No.	DATE	REVI SED No	PAGE	SUMMARY	NOTE
LD-24X03A	2012/10/25	-	-	-	
LD-24X03B	2012/12/12	△1	-	Update Page No in correction	
			3	correction of erroneous description (×)NC ⇒ (○)ENAB	
			5	Update 【*2】 in 5.Absolute Maximun Ratings	
			7	Update Timing characteristics "6.2 LED backlight" Changed VBR active timing (t11)	
			8	Added VBR(PWM) regulator values and Remark 【*7】	
			9	Update Timing characteristics input signal Added CLK Transition Time and Duty time	
			10	Update Input signal timing in Fig2. Added CLK Transition Time and Duty time	
			12	Amendment overlapped "Fig.2" (×) Fig2 Optical characteristics measurement method (○) Fig.3 Optical characteristics measurement method	
			14	Update 10. Handling Precautions	
			19	Added PET TAPE Standard to Fig 1.	
LD-24X03C	2013/7/12	△2	6	【*1】 correction of erroneous description added Timing "t7" Change of the "t2" stating point (×) Back light ⇒ (○) Back light state Updata "6-1. TFT-LCD panel driving" VIH : max is VCC VIL : min is 0v (GND) Amendment Ramark of "6-1. TFT-LCD panel driving" Input voltage (×) 【*4】 ⇒ (○) 【*3】	
			7	【*1】 correction of erroneous description Change of the "t12" stating point (×) Back light ⇒ (○) Back light state	
				【*3】 【*4】 correction of erroneous description 【*3】 (×) pull-down ⇒ (○) pull-up (×) 10kΩ ⇒ (○) 100kΩ 【*4】 (×) pull-down ⇒ (○) pull-up	
				Chane of Life time (50,000h ⇒ 70,000h)	

No.		page
1	Application	1
2	Overview	2
3	Mechanical Specifications	2
4	Input Terminals	3
5	Absolute Maximum Ratings	5
6	Electrical Characteristics	6
7	Timing characteristics of input signals	9
8	Input Signals, Basic Display Colors and Gray Scale of Each Color ..	11
9	Optical Characteristics	12
10	Handling Precautions	14
11	Packing form	16
12	Reliability test items	16
13	Others	17
14	Storage conditions	18
Fig.1	OUTLINE DIMENSIONS	19
Fig.4	PACKING FORM	20

1. Application

This specification applies to the color TFT-LCD module LQ121S1DG81.

This specification is the proprietary product of SHARP CORPORATION (SHARP) and include materials protected under copyright of SHARP. Do not reproduce or cause any third party to reproduce them in any form or by any means, electronic or mechanical, for any purpose, in whole or in part, without the express written permission of SHARP.

The device listed in this specification was designed and manufactured for use in general electronic equipment.

In case of using the device for applications such as control and safety equipment for transportation (controls of aircraft, trains, automobiles, etc.), rescue and security equipment and various safety related equipment which require higher reliability and safety, take into consideration that appropriate measures such as fail-safe functions and redundant system design should be taken.

Do not use the device for equipment that requires an extreme level of reliability, such as aerospace applications, telecommunication equipment (trunk lines), nuclear power control equipment and medical or other equipment for life support.

SHARP assumes no responsibility for any damage resulting from the use of the device which does not comply with the instructions and the precautions specified in this specification .

Contact and consult with a SHARP sales representative for any questions about this device.

2. Overview

This module is a color active matrix LCD module incorporating amorphous silicon TFT (Thin Film Transistor). It is composed of a color TFT-LCD panel, driver ICs, control circuit, power supply circuit and a White-LED Backlight unit. Graphics and texts can be displayed on a 800 × RGB × 600dots panel with 262144 colors by using CMOS(Complementary MOS) and supplying +3.3V DC supply voltages for TFT-LCD panel driving and supply voltage for backlight.

The maximum viewing angle is in the 6o'clock direction.

The 12o'clock direction is difficult to reverse the grayscale.

The LED driver circuit is built into the module.

3. Mechanical technical literatures

Parameter	technical literatures	Unit
Display size	31 (12.1inch) Diagonal	cm
Active area	246 (H) × 184.5 (V)	mm
Pixel format	800 (H) × 600 (V) (1pixel=R+G+B dot)	pixel
Aspect ratio	4:3	
Pixel pitch	0.3075 (H) × 0.3075 (V)	mm
Pixel configuration	R,G,B vertical stripe	
Display mode	Normally white	
Unit outline dimensions 【*1】	276.0 (W) × 209.0 (H) × 11.0 (D)	mm
Mass (MAX.)	650	g
Surface treatment	Anti-glare and hard-coating 3H	

【*1】 Excluding the protrusion of the connector cover from thickness.

Outline dimensions are shown in Fig.1.

4. Input Terminals

4-1. TFT-LCD panel driving

CN1 (Interface signals and +3.3V power supply)

Using connectors: DF9MA-41P-1V(32) (Hirose Electric Co., Ltd.)

Corresponding connectors: DF9-41S-1V(32), DF9A-41S-1V(32) (Hirose Electric Co., Ltd.)

: DF9B-41S-1V(32), DF9M-41S-1V(32) (Hirose Electric Co., Ltd.)

CN1

Pin	Symbol	Function	Remark
1	GND	GND	
2	CK	Clock signal for sampling each data signal	
3	GND	GND	
4	Hsync	Horizontal synchronous signal	Negative
5	Vsync	Vertical synchronous signal	Negative
6	GND	GND	
7	GND	GND	
8	GND	GND	
9	R0	RED data signal(LSB)	
10	R1	RED data signal	
11	R2	RED data signal	
12	GND	GND	
13	R3	RED data signal	
14	R4	RED data signal	
15	R5	RED data signal(MSB)	
16	GND	GND	
17	GND	GND	
18	GND	GND	
19	G0	GREEN data signal(LSB)	
20	G1	GREEN data signal	
21	G2	GREEN data signal	
22	GND	GND	
23	G3	GREEN data signal	
24	G4	GREEN data signal	
25	G5	GREEN data signal(MSB)	
26	GND	GND	
27	GND	GND	
28	GND	GND	
29	B0	BLUE data signal(LSB)	
30	B1	BLUE data signal	
31	B2	BLUE data signal	
32	GND	GND	
33	B3	BLUE data signal	
34	B4	BLUE data signal	
35	B5	BLUE data signal(MSB)	
36	GND	GND	
37	ENAB	Signal to settle the horizontal and vertical display position	
38	NC	No Connect (Please be sure to open)	
39	Vcc	+3.3V power supply	
40	Vcc	+3.3V power supply	
41	SCAN	Horizontal/Vertical display mode select signal	【*1】

△1

【*1】 RL/UD = LOW



RL/UD = HIGH



4-3. LED backlight

LED backlight connector

CN2 Used connector : SM06B-SHLS-TF (J.S.T. Mfg. Co. Ltd)

Corresponding connector : SHLP-06V-S-B (J.S.T. Mfg. Co. Ltd)

Connector No.	Pin No.	symbol	function
CN2	1	VDD	+12V power supply
	2	VDD	+12V power supply
	3	GND	GND
	4	GND	GND
	5	XSTABY	Backlight ON/OFF signal
	6	VBR	PWM signal

5. Absolute Maximum Ratings

Parameter	Symbol	Condition	Pin	Ratings	Unit	Remark
Supply voltage	V _{CC}	T _a =25°C	VCC	-0.3 ~ +4.0	V	【*1,2】
	V _{DD}	T _a =25°C	VDD	-0.3 ~ +15.0	V	【*1,2】
Input voltage	V _{I1}	T _a =25°C	R0-5,G0-5,B0-5 CK,Hsync,Vsync ENAB,SCAN	-0.3~V _{CC} +0.3	V	
	V _{I2}	T _a =25°C	XSTABY, VBR	-0.3~V _{DD}	V	
Storage temperature	T _{STG}	—	—	-30 ~ +80	°C	【*1】
Operating temperature	T _{OPA}	—	—	-30 ~ +80	°C	【*1,3,4】

【*1】 Humidity: 95%RH Max.(T_a ≤ 40°C) Note static electricity.

Maximum wet-bulb temperature at 39°C or less. (T_a > 40°C) No condensation.

【*2】 The V_{CC} power supply capacity must use the one of 2A or more.

The V_{DD} power supply capacity must use the one of 3A or more.

There is a possibility of causing smoking and the ignition without fusion of LCD fuse

when abnormality occurs when the current capacity is smaller than regulated values.

Please install the sprotection function in which the overcurrent and the excess voltage are controlled to the set side when you design the lower current supply.

【*3】 There is a possibility of causing deterioration in the irregularity and others of the screen and the display fineness though the liquid crystal module doesn't arrive at destruction when using it at 65~80°C.

【*4】 In the operating temperature item, the low temperature side is the ambient temperature regulations.

The high temperature side is the panel surface temperature regulations.

6. Electrical Characteristics

6-1. TFT-LCD panel driving

T_a = +25°C

Parameter	Symbol	Condition	Min.	Typ.	Max.	Unit	Remark
Supply voltage	V _{CC}		3.0	3.3	3.6	V	【*1】
Current dissipation	I _{CC}	V _{CC} =3.3V	-	400	500	mA	【*2】
Permissive input ripple voltage	V _{RP}		-	-	100	mV _{P-P}	V _{CC} = 3.3V
Input voltage	V _{IH}		2.1	-	V _{CC}	V	【*3】
	V _{IL}		0.0	-	0.8	V	
Input reak current	I _{OH}		-	-	400	μA	V _{I2} = +3.3V【*3】
	I _{OL}		-400	-	-	μA	V _{I2} = 0V【*3】

Δ2

【*1】 On-off conditions for supply voltage

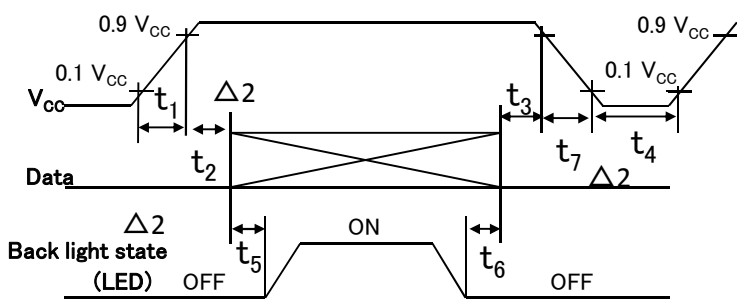

- 20 μs < t₁ ≤ 10ms
- 0 < t₂ ≤ 20ms
- 0 < t₃ ≤ 1s
- 1s ≤ t₄
- 300ms ≤ t₅
- 200ms ≤ t₆
- 20ms ≤ t₇ ≤ 200ms Δ2

V_{CC}-dip conditions

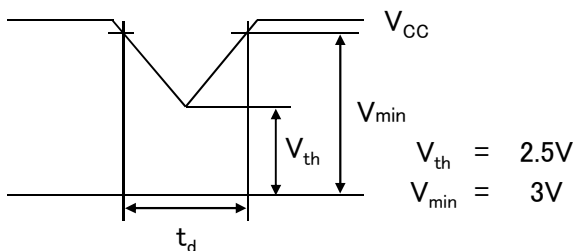

- V_{th} < V_{CC} ≤ V_{min}
t_d ≤ 10ms
 - V_{CC} < V_{th}
- V_{CC}-dip conditions should also follow the On-off conditions for supply voltage

- Hsync/Vsync need not be input so that this model may drive only by the ENAB signal. Even if Hsync/Vsync is input, it doesn't become a malfunction.
- The relation between the data input and the backlight lighting will recommend the above-mentioned input sequence. When the backlight is turned on before the panel operates, there is a possibility of abnormally displaying. The liquid crystal module is not damaged.

【*2】 Current dissipation

Typical current situation : 64-gray-bar pattern

(V_{CC}=+3.3V、f_{ck} = 40MHz、T_a=25°C)

【*3】 R0-5、G0-5、B0-5、CK、Hsyn、Vsync、ENAB、SCAN

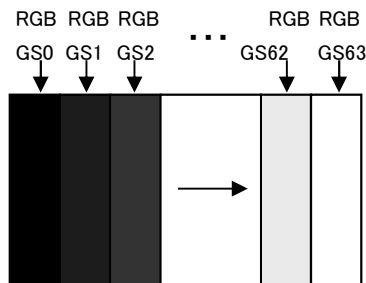

6-2. LED backlight

Ta=+25°C

Parameter	Symbol	Min.	Typ.	Max.	Unit	Remark	
Supply voltage	VDD	10.2	12.0	13.8	V	【*1】	
Current dissipation	IDD1	-	400	600	mA	【*2】	
	IDD2	-	-	10.0	μA		
Permissive input ripple voltage	VRP_BL	-	-	200	mV _{P-P}	VDD=+12.0V	
XSTABY	High voltage	VIH_BL1	9.0	-	VDD	V	【*3】
	Low voltage	VIL_BL1	-	-	0.4	V	【*3】
VBR	High voltage	VIH_BL2	9.0	-	VDD	V	【*4】
	Low voltage	VIL_BL2	-	-	0.4	V	【*4】
PWM	Frequency	fPWM	200	-	1k	Hz	【*4,5】
	Duty	DPWM	10	-	100	%	【*4,5】
	Pulse width (Lo)	LPWM	-	-	4.5	ms	【*5,7】
	Pulse width (Hi)	HPWM	0.1	-	-	ms	【*5】
Life time	L	-	(70,000) (Module)	-	h	【Reference】 【*6】	

Δ1

Δ1

Δ2

【*1】 On-off conditions for supply voltage

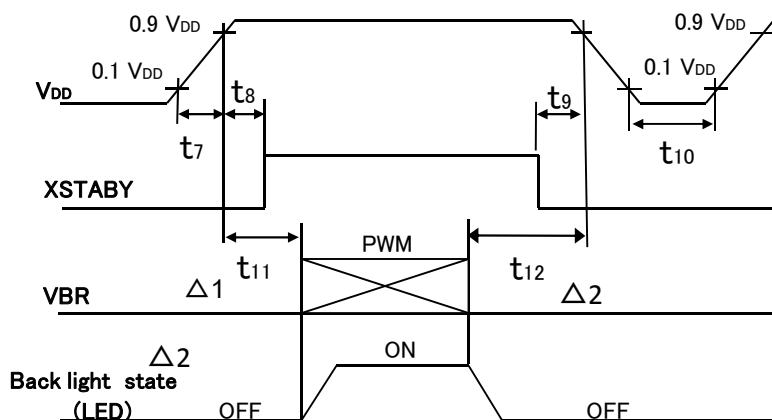

$$20 \mu s \leq t_7 \leq 200ms$$

$$0ms \leq t_8$$

$$0ms \leq t_9$$

$$200mms \leq t_{10}$$

$$0ms \leq t_{11} \quad \Delta 1$$

$$0ms \leq t_{12}$$

【*2】 Current dissipation

Typ. value: VDD= +12V、Duty=100%

Max. value: VDD= +10.2V、Duty=100%

【*3】 XSTABY is connected by the pull-up resistor of 100kΩ.

Δ2

【*4】 VBR is connected by the pull-up resistor of 10kΩ.

Δ2

【*5】 PWM

$$f_{\text{PWM}} = 1/t_{14}$$

$$\text{DPWM} = t_{13} / t_{14}$$

Duty 10% : Min. Luminance

Duty 100% : Max. Luminance

Luminance changes in proportion to the duty ratio. ($t_{13} \geq 500 \mu\text{s}$)

When the frequency slows, the display fineness might decrease.

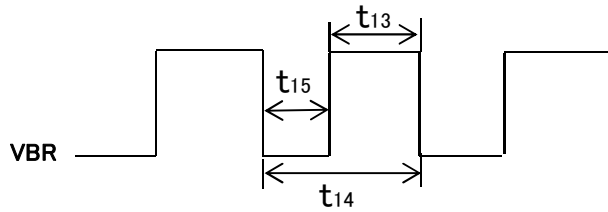

【*6】 Luminance becomes 50% of an initial value. ($T_a = 25^\circ\text{C}$, PWM=100%)

【*7】 When VBR signal is set “Low” more than 4.5ms, please turn off XSTABY.

△1

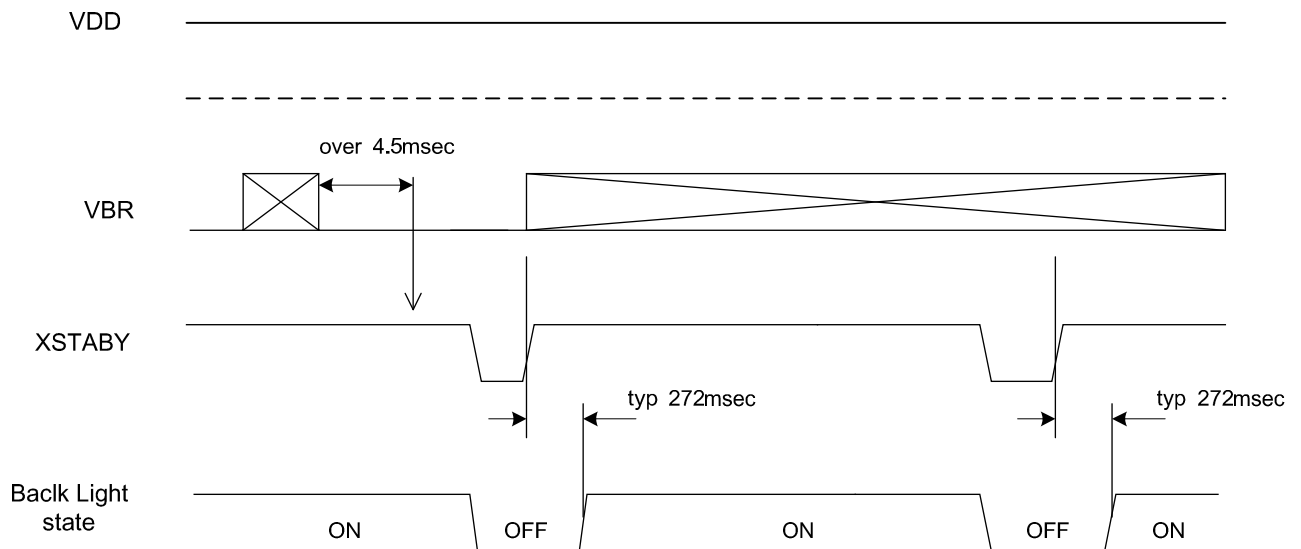

7. Timing characteristics of input signals

7-1. Timing characteristics

Input signal timing waveform is shown in Fig.2.

Parameter		Symbol	min	typ	max	unit	remark
Clock $\Delta 1$	Frequency	$1/T_c$	35	40	42	MHz	
	High time	T_{ch}	6	—	—	ns	
	Low time	T_{cl}	6	—	—	ns	
	Transition time	T_{cit}	—	—	5	ns	
	Duty	T_{cd}	$0.35T_c$	$0.5T_c$	$0.65T_c$	ns	【*2】
Data	Setup time	T_{ds}	3	—	—	ns	
	Hold time	T_{dh}	5	—	—	ns	
ENAB	Setup time	T_{es}	5	—	—	ns	
ENAB	Horizontal period	TH	832	1056	1395	clock	
			23.5	26.4	39.9	μs	
	Horizontal period (High)	THd	800	800	800	clock	
	Vertical Frequency	TV	625	666	798	line	【*1】
			—	17.6	—	ms	
Vertical period (High)	TVd	600	600	600	line		

【*1】 In case of using the long vertical period, the deterioration of display quality, flicker etc. may occur.

【*2】 T : Clock period time

7-2. Input Data Signals and Display Position on the screen

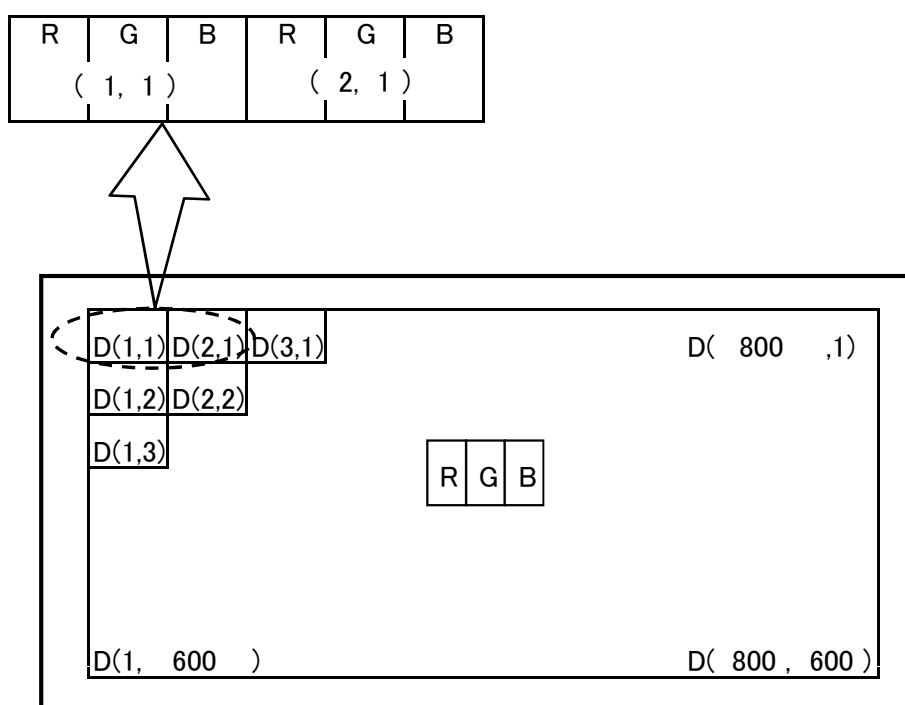

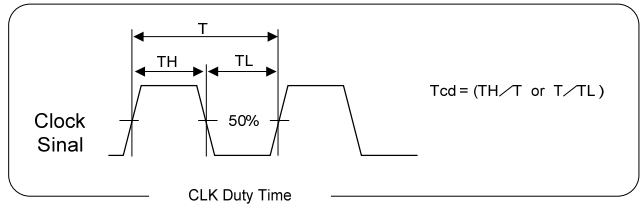
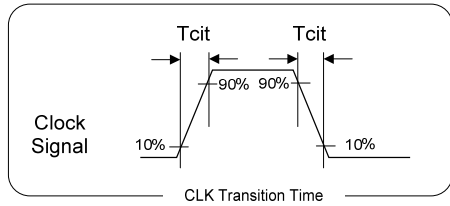
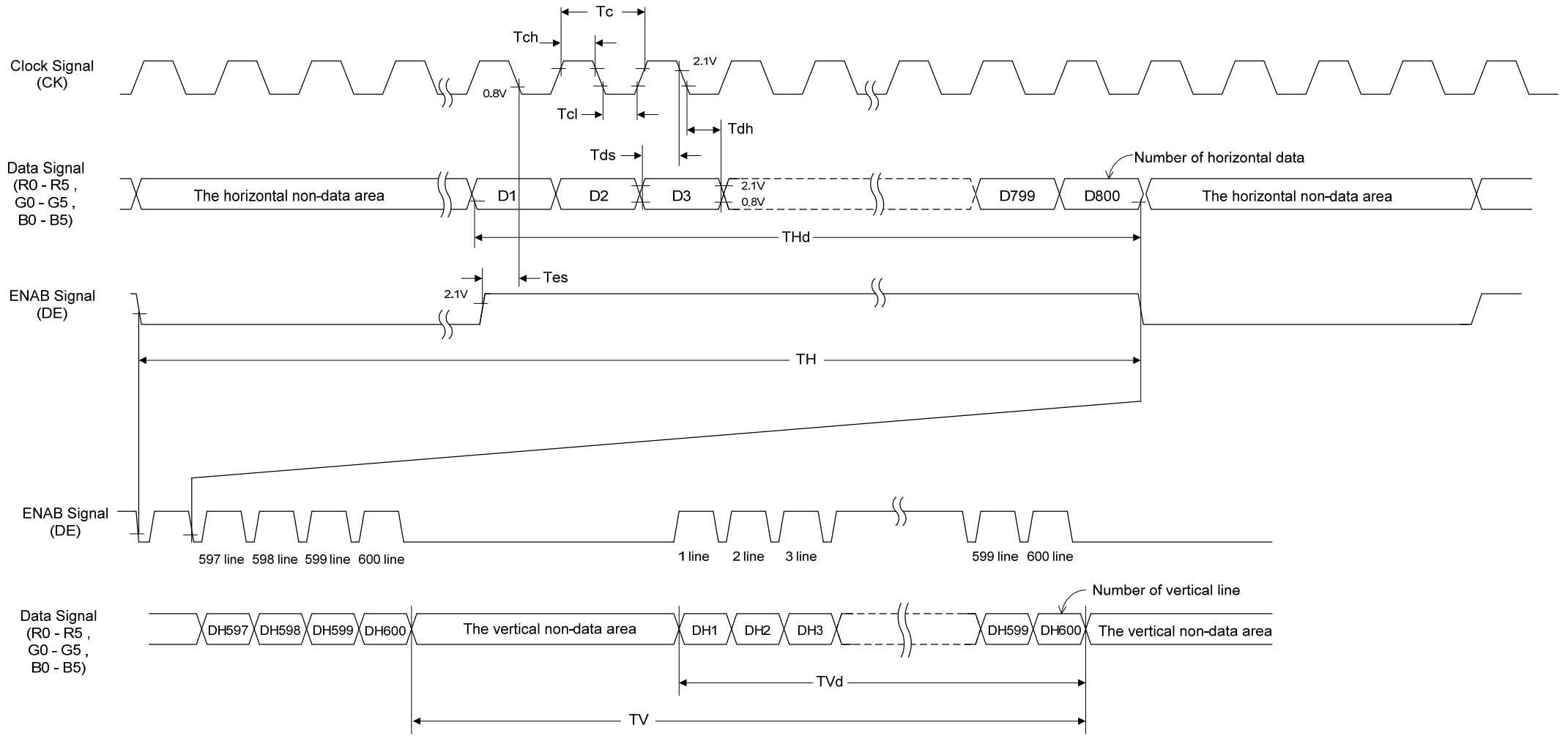

Fig2 Input signal timing $\Delta 1$

8. Input Signals, Basic Display Colors and Gray Scale of Each Color

	Colors & Gray scale	Data signal																		
		GrayScale	R0	R1	R2	R3	R4	R5	G0	G1	G2	G3	G4	G5	B0	B1	B2	B3	B4	B5
Basic Color	Black	—	0	0	0	0	0	0	0	0	0	0	0	0	0	0	0	0	0	0
	Blue	—	0	0	0	0	0	0	0	0	0	0	0	0	1	1	1	1	1	1
	Green	—	0	0	0	0	0	0	1	1	1	1	1	1	0	0	0	0	0	0
	Cyan	—	0	0	0	0	0	0	1	1	1	1	1	1	1	1	1	1	1	1
	Red	—	1	1	1	1	1	1	0	0	0	0	0	0	0	0	0	0	0	0
	Magenta	—	1	1	1	1	1	1	0	0	0	0	0	0	1	1	1	1	1	1
	Yellow	—	1	1	1	1	1	1	1	1	1	1	1	1	0	0	0	0	0	0
	White	—	1	1	1	1	1	1	1	1	1	1	1	1	1	1	1	1	1	1
Gray Scale of Red	Black	GS0	0	0	0	0	0	0	0	0	0	0	0	0	0	0	0	0	0	0
	↑	GS1	1	0	0	0	0	0	0	0	0	0	0	0	0	0	0	0	0	0
	Darker	GS2	0	1	0	0	0	0	0	0	0	0	0	0	0	0	0	0	0	0
	↑	↓	↓					↓					↓							
	↓	↓	↓					↓					↓							
	Brighter	GS61	1	0	1	1	1	1	0	0	0	0	0	0	0	0	0	0	0	0
	↓	GS62	0	1	1	1	1	1	0	0	0	0	0	0	0	0	0	0	0	0
Red	GS63	1	1	1	1	1	1	0	0	0	0	0	0	0	0	0	0	0	0	
Gray Scale of Green	Black	GS0	0	0	0	0	0	0	0	0	0	0	0	0	0	0	0	0	0	0
	↑	GS1	0	0	0	0	0	0	1	0	0	0	0	0	0	0	0	0	0	0
	Darker	GS2	0	0	0	0	0	0	0	1	0	0	0	0	0	0	0	0	0	0
	↑	↓	↓					↓					↓							
	↓	↓	↓					↓					↓							
	Brighter	GS61	0	0	0	0	0	0	1	0	1	1	1	1	0	0	0	0	0	0
	↓	GS62	0	0	0	0	0	0	0	1	1	1	1	1	0	0	0	0	0	0
Green	GS63	0	0	0	0	0	0	1	1	1	1	1	1	0	0	0	0	0	0	
Gray Scale of Blue	Black	GS0	0	0	0	0	0	0	0	0	0	0	0	0	0	0	0	0	0	0
	↑	GS1	0	0	0	0	0	0	0	0	0	0	0	0	1	0	0	0	0	0
	Darker	GS2	0	0	0	0	0	0	0	0	0	0	0	0	0	1	0	0	0	0
	↑	↓	↓					↓					↓							
	↓	↓	↓					↓					↓							
	Brighter	GS61	0	0	0	0	0	0	0	0	0	0	0	0	1	0	1	1	1	1
	↓	GS62	0	0	0	0	0	0	0	0	0	0	0	0	0	1	1	1	1	1
Blue	GS63	0	0	0	0	0	0	0	0	0	0	0	0	1	1	1	1	1	1	

Each basic color can be displayed in 64 gray scales from 6 bit data signals. According to the combination of total 18 bit data signals, the 262,144-color display can be achieved on the screen.

9. Optical Characteristics

$T_a=+25^{\circ}\text{C}$, $V_{cc}=+3.3\text{V}$

Parameter		Symbol	Condition	Min.	Typ.	Max.	Unit	Remark	
Viewing angle range	Horizontal	θ_{21}, θ_{22}	CR>10	60	80	-	Deg.	【*1,2,4】	
	Vertical	θ_{11}		35	60	-	Deg.		
		θ_{12}		60	80	-	Deg.		
Contrast ratio		CR	optimized angle	500	800	-		【*2,4】	
Response Time	White Black	$\tau_r + \tau_d$	$\theta = 0^{\circ}$	-	30	-	ms	【*3,4】	
Chromaticity of White	W_x			0.235	0.305	0.375		【*4】	
	W_y			0.260	0.330	0.400			
Chromaticity of Red	R_x			-	0.585	-			
	R_y			-	0.340	-			
Chromaticity of Green	G_x			-	0.325	-			
	G_y			-	0.570	-			
Chromaticity of Blue	B_x			-	0.145	-			
	B_y			-	0.130	-			
Luminance of white		Y_{L1}			350	450	-		cd/m^2
White Uniformity				-	-	1.33			【*5】

※The measurement shall be executed 30 minutes after lighting at rating.

The optical characteristics shall be measured in a dark room or equivalent state with the method shown in Fig.3 below.

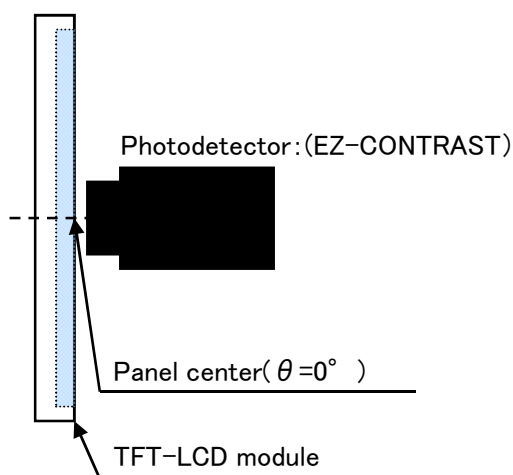

fig.3-1 Measuring method of Viewing angle range.

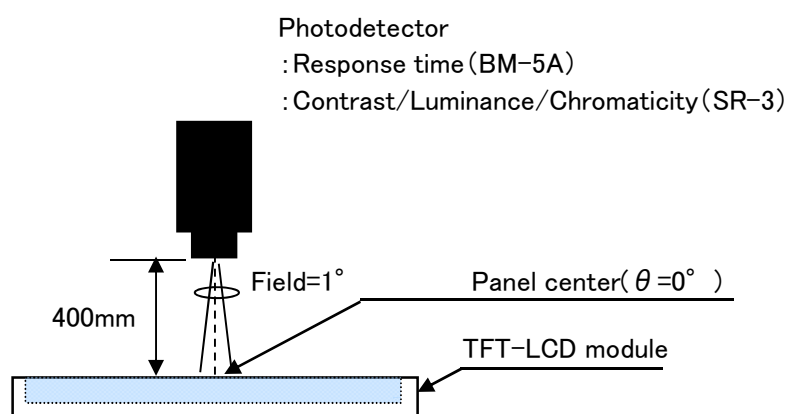
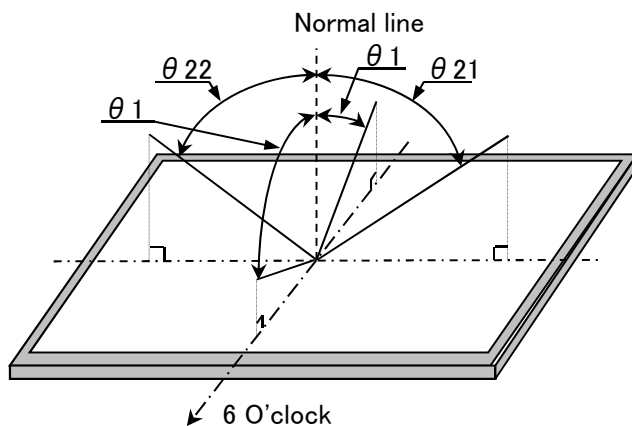

fig.3-2 Measuring method of contrast, luminance, response time, and Chromaticity.

Fig.3 Optical characteristics measurement method

【*1】Definitions of viewing angle range:



【*2】Definition of contrast ratio:

The contrast ratio is defined as the following.
$$\text{Contrast (CR)} = \frac{\text{Luminance with all pixels white}}{\text{Luminance with all pixels black}}$$

【*3】Definition of response time:

The response time is defined as the following figure and shall be measured by switching the input signal for "black" and "white".

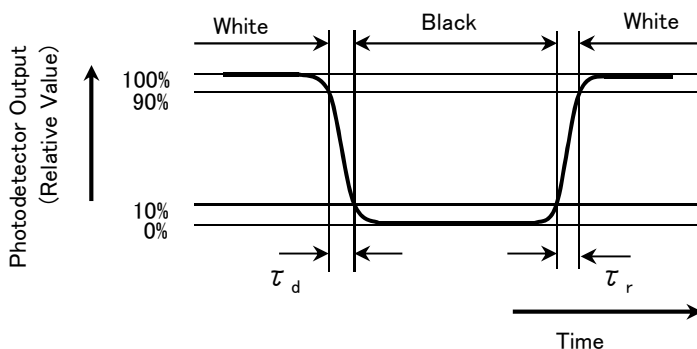

【*4】This shall be measured at center of the screen.

【*5】Definition of white uniformity:

White uniformity is defined as the following with five measurements.

(①~⑤)

$$\delta_w = \frac{\text{Maximum luminance of 5 points(①~⑤)}}{\text{Minimum luminance of 5 points(①~⑤)}}$$

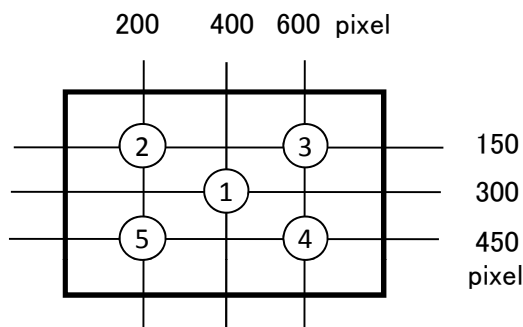

10. Handling Precautions

【Handling Precautions】

- a) Treat LCD module in dustless surroundings. Metal foreign material stuck to the circuit is possible to cause a short.
- b) Be sure to design the cabinet so that the module can be installed without any extra stress such as warp or twist.
- c) Be careful not to give any physical stress onto the circuit and/or the connector of LCD module when you pull/plug a cable. Physical stress will cause a break or worse connection.
- d) Since the front polarizer is easily damaged, pay attention not to scratch it.
- e) Use N₂-blower such as an ionized nitrogen has anti-electrostatic when you blow dusts on Polarizer.
- f) Since a long contact with water may cause discoloration or spots, wipe it with absorbent cotton or other soft cloth immediately.
- g) Since CMOS LSI is used in this module, take care of static electricity and injure the human earth when handling. Observe all other precautionary requirements in handling components.
- h) Be careful with the edge parts of the module which is made of metal.
- i) Since the panel is made of glass, it may break or crack if dropped or bumped on hard surface. Handle with care.
- j) When the panel is broken, don't touch the glass. Although the panel is difficult to be scattered, touching the broken part may hurt your hands.
- k) Liquid crystal contained in the panel may leak if the LCD is broken. Rinse it as soon as possible if it gets inside your eye or mouth by mistake.
- l) Don't touch the circuit and the pattern of the board. If you touch it, the circuit may be broken.
- m) Follow the regulations when LCD module is scrapped. The government you stay may have some regulations about it.

【Set-Design Precautions】

- a) Notice : Never take to pieces the module , because it will cause failure. Please don't remove the fixed tape, insulating tape etc. that was pasted on the original module. (except for protection film of the panel)
- b) Protection film is attached to the module surface to prevent it from being scratched .Peel the film off slowly , just before the use, with strict attention to electrostatic charges. Blow off 'dust' on the polarizer by using an ionized nitrogen.
- c) Be sure to design the cabinet so that the module can be installed without any extra stress such as warp or twist.
- d) Connect GND to frame of module to stabilize against EMI and external noise.
- e) When install LCD modules in the cabinet, please tighten with("torque=0.294±0.02N·m(3.0±0.2kgf·cm)"). Be sure to confirm it in the same condition as it is installed in your instrument.
- f) Since there is a circuit board in the module back, stress is not added at the time of a design assembly. Please make it like. If stress is added, there is a possibility that circuit parts may be damaged.
- g) It causes an irregular display and the defective indication, etc., when always put constant pressure on the back of the module. Please do not make the structure to press the back of the module.
- h) Be careful of a back light FPC not to pull by force at the time of the connecting to a W-LED driver, or FPC processing.

- i) The polarizer surface on the panel is treated with Anti-Glare for low reflection. In case of attaching
Be sure to design the cabinet so that the module can be installed without any extra stress such as warp or twist.
- j) Don't change the volume of LCD module. It is optimized when the shipping. Any change may not meet the specification.
- k) If a minute particle enters in the module and adheres to an optical material, it may cause display non-uniformity issue, etc.
Therefore, fine-pitch filters have to be installed to cooling and inhalation hole if you intend to install a fan.
- l) Be sure to follow the absolute maximum rating in the specification. The design should consider the surrounding temperature, the fluctuating input signal, and tolerance of the electronic parts. Exceeding values is possible to cause worse characteristic such as burn and/or broken of the parts on LCD module.
- m) Be sure to use LCD module within the recommended operating conditions. Operating module out of the recommended range is not guaranteed even if it is in the absolute maximum rating.
- n) Follow the power, signal, and supply voltage sequence which the specification indicates, regarding on-off input signal after power on of LCD module.
- o) According to the using application, power circuit protection is recommended at module failure.

【Operation Precautions】

- a) Do not expose the LCD panel to direct sunlight. Lightproof shade etc. should be attached when LCD panel is used under such environment.
- b) When handling LCD modules and assembling them into cabinets, please avoid that long-terms storage in the environment of oxidization or deoxidization gas and the use of such materials as reagent, solvent, adhesive, resin, etc. which generate these gasses, may cause corrosion and discoloration of the modules.
Do not use the LCD module under such environment.
- c) An abnormal display by changing in quality of the polarizing plate might occur regardless of contact or no contact to the polarizing plate, because of epoxy resin (amine system curing agent) that comes out from the material and the packaging material used for the set side, the silicon adhesive (dealcoholization system and oxime system), and the tray blowing agents (azo-compound), etc. Please confirm adaptability with your employed material.
- d) Don't use polychloroprene (CR) with LCD module. It will generate chlorine gas, which will damage the reliability of the connection part on LCD panel.
- e) Be careful when using it for long time with fixed pattern display as it may cause accidental image.
Please use a screen saver etc., in order to avoid an afterimage.
- f) The LED (Light Emitting Diode) used in this LCD module is very sensitive to temperature change. If it operates for extremely long time under high temperature, it is possible rapidly to shorten the life time of LED.
In case of such a condition, consult with us.
- g) If stored at the temperatures lower than the rated storage temperature, the LC may freeze and it may cause LCD panel damage. If storage temperature exceeds the specified rating, the molecular orientation of the LC may change to that of a liquid, and they may not revert to their original state. Store the module in normal room temperature.
- h) Keep LCD module in the range of the specified temperature conditions at all times. Once out of the range, liquid crystal will lose its characteristics, and it cannot recover.
- i) Nature of dew consideration prevention is necessary when LCD is used for long time under high-temperatur and high-humidity.

11. Packing form

- a) Piling number of cartons : MAX. 6
- b) Package quantity in one carton: 20pcs
- c) Carton size(TYP): 517mm(W) × 432mm(D) × 347mm(H)
- d) Total mass of one carton filled with full modules(20pcs): 15kg

12. Reliability test items

No.	Test item	Conditions	Remark
1	High temperature storage test	Ambient temperature 80°C 240H	【Note1】
2	Low temperature strage test	Ambient temperature -30°C 240H	【Note1】
3	High temperature & high humidity operation test	Ambient temperature 40°C、Humidity 95% RH 240H (No condensation.)	【Note1】
4	High temperature operation test	Panel surface 80°C 240H	【Note1】
5	Low temperature operation test	Ambient temperature -30°C 240H	【Note1】
6	Vibration test (non-operating)	< Sin wave > Frequency : 10~57Hz/Vibration width (one side) : 0.076mm : 57~500Hz/Gravity: 9.8m/s ² Sweep time : 11minutes Test period : 3H(X, Y, Z direction 1H)	【Note1】
7	Shock test (non-operating)	Max. gravity: 490m/s ² Pulse width: 11ms Direction: ±X, ±Y, ±Z Test period : 1time/1direction	【Note1】
8	Thermal shock test (non-operating)	-30°C[0.5h]~80°C[0.5h]/50cycles	【Note1】

【Note1】 Under the display quality test conditions with normal operation state, these shall be no change which may affect practical display function. (normal operation state: Temperature:15~35°C, Humidity:45~75%, Atmospheric pressure:86~106kpa)

13. Others

13-1. Lot No Label:

A) Module serial label

The label that displays SHARP·Model No.(LQ121S1DG81) ·Lot No. is stuck on the back of the module.

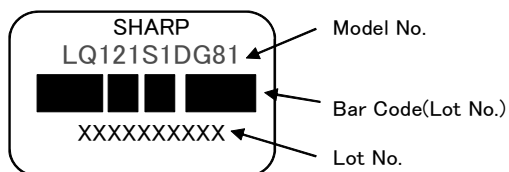

Lot No display method(Figure and alphabet)

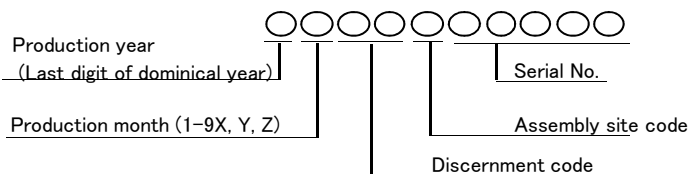

13-2. Packing box Label:

The label that displays ①Model number(LQ121S1DG81) ②Lot number ③Quantity of module is stuck on the packing box. Moreover, the display of bar code also applies to this.

社内品番:	(4S) LQ121S1DG81
Barcode(①)	
Lot No. :	(1T) 2012. 10. 25 **
Barcode(②)	
Quantity :	(Q) 20 pcs
Barcode(③)	
ユーザー品番 :	
シャープ物流用ラベルです。	-----

- ① Model number(LQ121S1DG81)
- ② Lot number (DATA)
- ③ Quantity of module

Our management product number might be filled in.
(Example: LQ121S1DG81A etc.)

A right picture is written to the packing box of module for the RoHS restriction.

※ R.C.(RoHS Compliance)means these parts have corresponded with the RoHS directive.

This module corresponds from the first sample to RoHS Directive.

R.C.

13-3. The ozone-depleting substances is not used.

13-4. If any problem occurs in relation to the description of this specification , it shall be resolved through discussion with spirit of cooperation.

14. Storage conditions

Environmental condition range of storage temperature and humidity

Temperature 0 to 40 degrees Celsius

Relative humidity 95% and below

【Note】Please refer below as a mean value of the environmental conditions.

Summer time temperature 20 to 35 degrees Celsius humidity , 85% and below

Winter time temperature 5 to 15 degrees Celsius humidity , 85% and below

Please maintain within 240 hours of accumulated length of storage time, with conditions of 40 degrees Celsius and room humidity of 95%.

Direct sun light

Please keep the product in a dark room or cover the product to protect from direct sun light.

Atmospheric condition

Please refrain from keeping the product with possible corrosive gas or volatile flux.

Prevention of dew

Please store the product carton either on a wooden pallet or a stand / rack to prevent dew.

Do not place directly on the floor. In addition, to obtain moderate ventilation in between the pallet's top and bottom surfaces, pile the cartons up in a single direction and in order.

Please place the product cartons away from the storage wall.

Storage period

Within above mentioned conditions, maximum storage period should be one year.

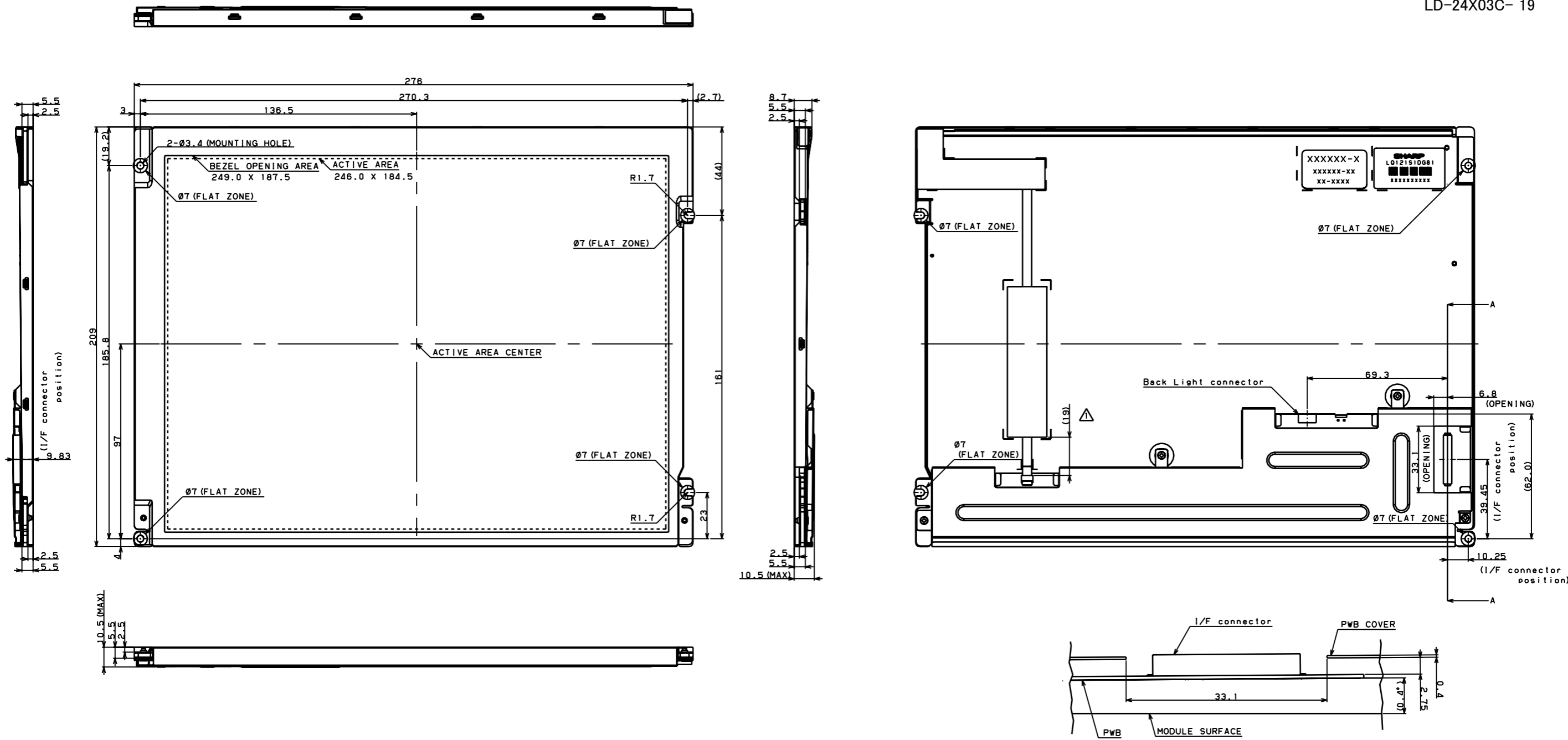

BEZEL/DISPLAY POSITION

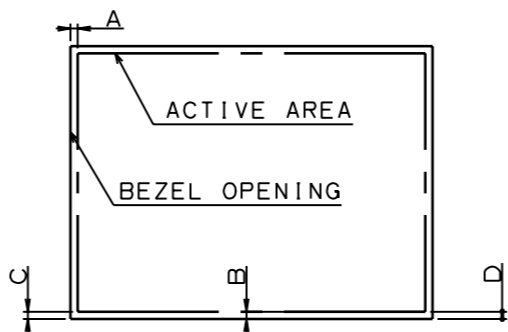

- 1) TOLERANCE X-DIRECTION A: 1.5 ± 0.8
- 2) TOLERANCE Y-DIRECTION B: 1.5 ± 0.8
- 3) OBLIQUITY OF DISPLAY AREA IC-DI < 0.8

- SECTION A-A
- NOTES
- 1) UNSPECIFIED TOLERANCE TO BE ± 0.5
 - 2) WARP AND FLOATING FOR PWB COVER • FFC • CHASSIS ARE EXCLUDED FROM THE THICKNESS OF THE UNIT.
 - 3) TIGHTEN TORQUE (RECOMMENDATION) : $0.294 \pm 0.02 \text{ N} \cdot \text{m}$ ($3.0 \pm 0.2 \text{ kgf} \cdot \text{cm}$)
 ※ PLEASE CONFIRM WHETHER THERE IS THE PROBLEM SUCH AS LOOSENING OF THE SCREW IN A REAL MACHINE.
 - 4) NEVER TAKE TO PIECES THE MODULE, BECAUSE IT WILL CAUSE FAILURE. PLEASE DO NOT PEEL OFF THE PWB COVER, SCREW, TAPE PASTED TO THE PRODUCT.

Fig. 1 : LQ121S1DG81 OUTLINE DIMENSIONS

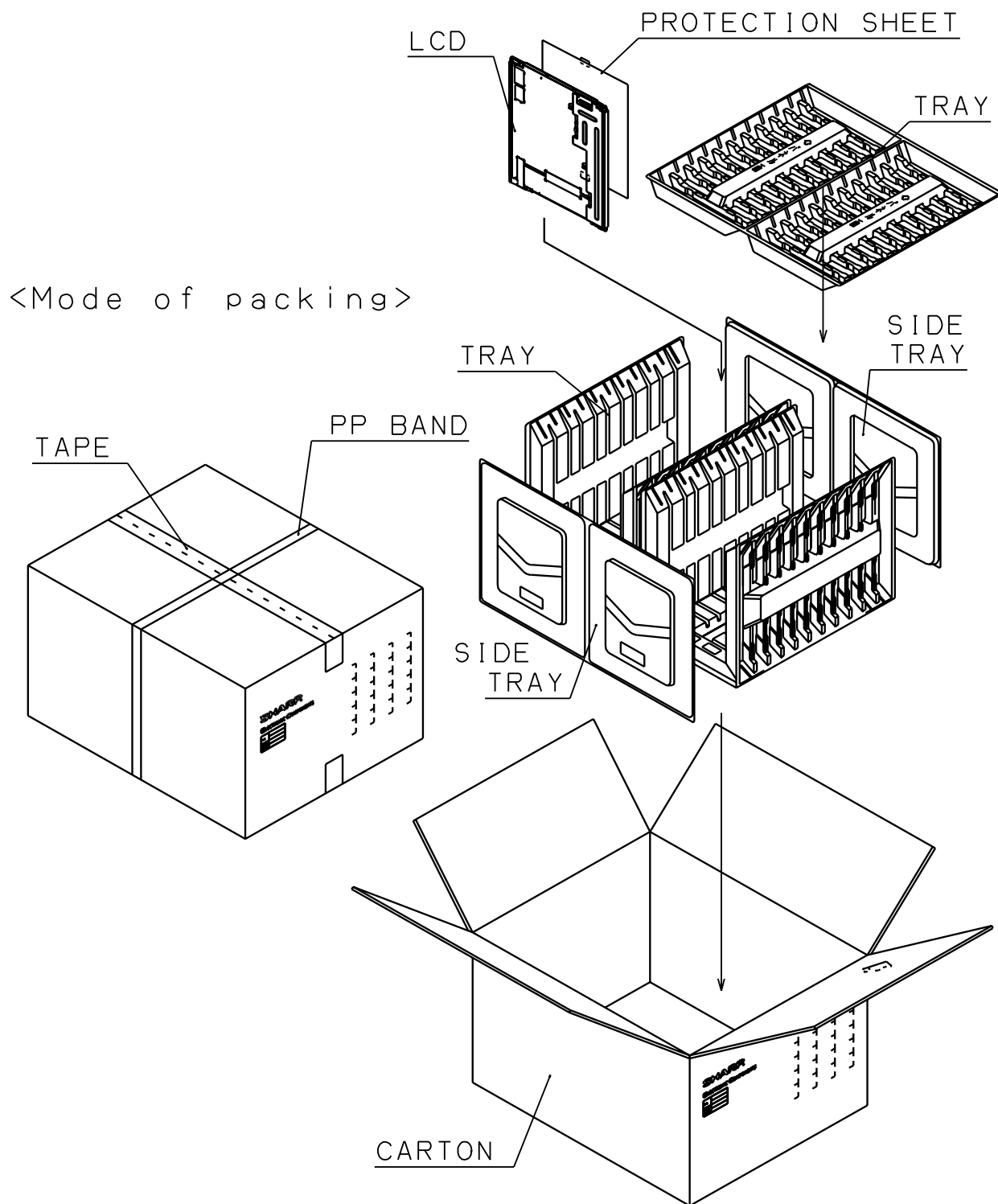

Fig.4 : PACKING FORM