

TFT-DISPLAY DATASHEET

STARTEK
Model: KDO43WQTPA035-RT

BRIEF SPEC.:

Main Feature	Touch
	Wide Operation Temperature
	Wide Viewing Angle
<hr/>	
Active Screen Area	95.04 x 53.86 (mm)
Diagonal Format	4,3" 16:9
Resolution	480 X 272
Colors	65K/262K/16.7M
Backlight	LED
Brightness	350 cd/m ²
LED Life Time	50k (h)
Interface	RGB
Viewing Angle	70/70 L/R 60/70
Touchscreen	yes
Power Supply	3.3V (Typ.)
Module Outline	105.4 x 67.15 x 3.96 (mm)
Operation Temperature	- 20 ... + 70 °C
Storage Temperature	- 30... + 80 °C



SPECIFICATION
FOR
LCM+RTP Module
KD043WQTPA035-RT

MODULE:	KD043WQTPA035-RT
CUSTOMER:	

STARTEK	INITIAL	DATE
PREPARED BY		
CHECKED BY		
APPROVED BY		

CUSTOMER	INITIAL	DATE
APPROVED BY		

Part. No	KD043WQTPA035-RT	REV	V1.0	Page 1 of 32
----------	------------------	-----	------	--------------

常备库存
Stock For Sale

长期供货
Long Time supply

支持小量
NO MOQ

品种齐全
In Full Range

Contents

1.	Block Diagram	6
2.	Outline dimension	7
3.	Input terminal Pin Assignment	8
4.	LCD Optical Characteristics	9
4.1	Optical specification	9
4.2	Measuring Condition	9
5.	Electrical Characteristics	12
5.1	Absolute Maximum Rating (Ta=25 VSS=0V)	12
5.2	DC Electrical Characteristics	12
5.3	LED Backlight Characteristics	13
6.	TP Feature	15
6.1	Conditions of use and storage	15
6.2	Electrical property	15
6.3	Mechanical property	16
6.4	Optical property	16
7.	AC Characteristic	17
7.1	Input signal characteristics	17
7.2	AC Timing Diagram	18
7.2.1	Clock and Data Input Timing Diagram	18
7.2.2	SYNC Mode	18
7.3	3-Wire Communication Timing Diagram	19
7.4	RGB Input Timing Table	19
7.4.1	Parallel 24-bit RGB Timing Table	19
7.4.2	Series 8-bit RGB Timing Table	20
7.5	SYNC Mode Timing Diagram	21
7.6	SYNC-DE Mode Timing Diagram	22
8.	LCD Module Out-Going Quality Level	23
8.1	VISUAL & FUNCTION INSPECTION STANDARD	23
8.1.1	Inspection conditions	23
8.1.2	Definition	23
8.1.3	Sampling Plan	24
8.1.4	Criteria (Visual)	25
9.	Reliability Test Result	30
10.	Cautions and Handling Precautions	31

Part. No	KD043WQTPA035-RT	REV	V1.0	Page 3 of 32
----------	------------------	-----	------	--------------

常备库存
Stock For Sale

长期供货
Long Time supply

支持少量
NO MOQ

品种齐全
In Full Range

10.1 Handling and Operating the Module	31
10.2 Storage and Transportation.....	31
11. Packing.....	32

Part. No	KD043WQTPA035-RT	REV	V1.0	Page 4 of 32
	常备库存 Stock For Sale	长期供货 Long Time supply	支持小量 NO MOQ	品种齐全 In Full Range

*** Description**

This is a color active matrix TFT (Thin Film Transistor) LCD (liquid crystal display) that uses amorphous silicon TFT as a switching device. This model is composed of a Transmissive type TFT-LCD Panel, driver circuit, 4 wires resistance touch screen back-light unit. The resolution of a 4.3'TFT-LCD contains 480X272 pixels, and can display up to 65K/262K/16.7M colors.

*** Features**

General Information Items	Specification	Unit	Note
	Main Panel		
Display area(AA)	95.04(H) *53.86(V) (4.3 inch)	mm	-
Driver element	TFT active matrix	-	-
Display colors	65K/262K/16.7M	colors	-
Number of pixels	480(RGB)*272	dots	-
TFT Pixel arrangement	RGB vertical stripe	-	-
Pixel pitch	0.198 (H) x 0.198 (V)	mm	-
Viewing angle	12:00	o'clock	-
TFT Controller IC	ST7282	-	-
Display mode	Transmissive/Normally White	-	-
LCM Interface	16/18/24BIT RGB	-	-
Operating temperature	-20~+70	°C	-
Storage temperature	-30~+80	°C	-

*** Mechanical Information**

Item		Min.	Typ.	Max.	Unit	Note
Module size	Horizontal(H)		105.4		mm	-
	Vertical(V)		67.15		mm	-
	Depth(D)		3.96		mm	-
Weight			56.5		g	-

1. Block Diagram

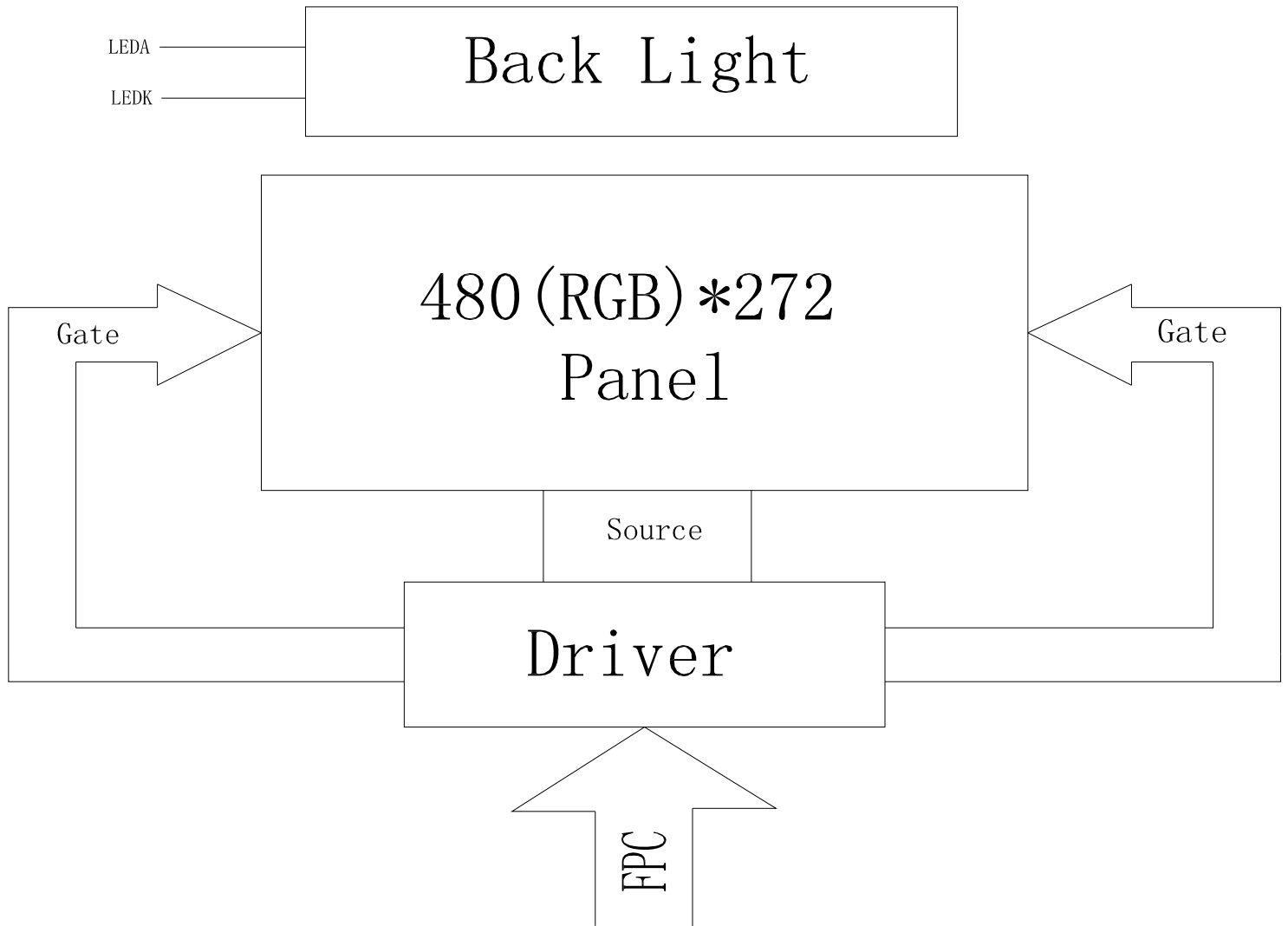

Part. No	KD043WQTPA035-RT	REV	V1.0	Page 6 of 32
	常备库存 Stock For Sale	长期供货 Long Time supply	支持少量 NO MOQ	品种齐全 In Full Range

3. Input terminal Pin Assignment

NO.	SYMBOL	DISCRIPTION	I/O
1	LEDK	Cathode pin of backlight	P
2	LEDA	Anode pin of backlight	P
3	GND	Ground.	P
4	VDD	Supply voltage(3.3V).	P
5-12	R0-R7	8-bit digital Red data input	I
13-20	G0-G7	8-bit digital Green data input	I
21-28	B0-B7	8-bit digital Blue data input	I
29	GND	Ground.	P
30	PCLK	Clock signal; latching data at the falling edge	I
31	DISP	Display control / standby mode selection. DISP = "Low" : Standby; (Default) DISP = "High" : Normal display	I
32	HSYNC	Horizontal sync signal; negative polarity	I
33	VSYNC	Vertical sync signal; negative polarity	I
34	DE	Data input enable. Active High to enable the data input When not used in SYNC mode, user should connect it to "Low".	I
35	NC	--	--
36	GND	Ground.	P
37	XR(NC)	Touch panel Right Glass Terminal	A/D
38	YD(NC)	Touch panel Bottom Film Terminal	A/D
39	XL(NC)	Touch panel Left Glass Terminal	A/D
40	YU(NC)	Touch panel Top Film Terminal	A/D

4. LCD Optical Characteristics

4.1 Optical specification

Item	Symbol	Condition	Min.	Typ.	Max.	Unit.	Note
Contrast Ratio	CR	$\Theta=0$	250	350	--		
Response time	Rising	T_{R+T_F}	Normal viewing angle	--	30	45	msec
	Falling			--			
Color gamut	S(%)		--	50	--	%	
Color Filter Chromaticity	White	W_X		0.259	0.299	0.339	
		W_Y		0.293	0.333	0.373	
	Red	R_X		0.558	0.598	0.638	
		R_Y		0.306	0.346	0.386	
	Green	G_X		0.301	0.341	0.381	
		G_Y		0.567	0.607	0.647	
	Blue	B_X		0.110	0.150	0.190	
		B_Y		0.046	0.086	0.126	
Viewing angle	Hor.	Θ_L	CR>10	--	70	--	
		Θ_R		--	70	--	
	Ver.	Θ_U		--	60	--	
		Θ_D		--	70	--	
Option View Direction	12:00 O"Clock						

4.2 Measuring Condition

- Measuring surrounding: dark room
- Ambient temperature: $25\pm 2^\circ\text{C}$
- 15min. warm-up time.

Part. No	KD043WQTPA035-RT	REV	V1.0	Page 9 of 32
----------	------------------	-----	------	--------------

常备库存
Stock For Sale

长期供货
Long Time supply

支持小量
NO MOQ

品种齐全
In Full Range

Note 1. Ambient condition : $25^{\circ}\text{C} \pm 2^{\circ}\text{C}$, $60 \pm 10\% \text{RH}$, under 10 Lux in the darkroom .

Note 2. Measure device : BM-5A (TOPCON) , viewing cone = 2° , $I_L = 20\text{mA}$.

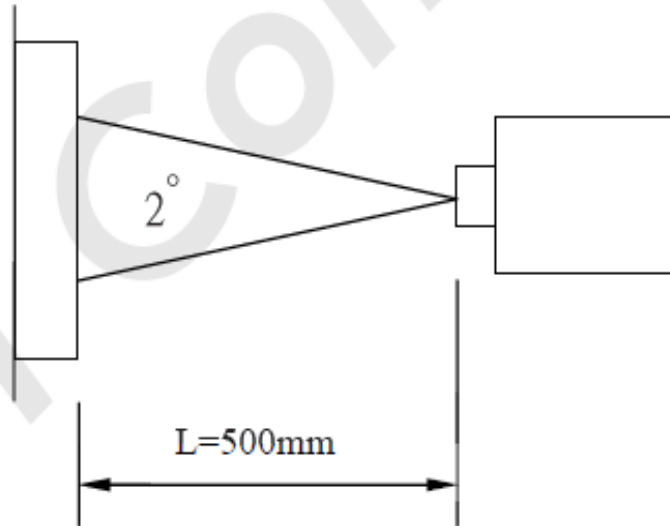

Note 3. Definition of Contrast Ratio :

$$\text{CR} = \text{White Luminance (ON)} / \text{Black Luminance (OFF)}$$

Part. No	KD043WQTPA035-RT	REV	V1.0	Page 10 of 32
----------	------------------	-----	------	---------------

常备库存
Stock For Sale

长期供货
Long Time supply

支持小量
NO MOQ

品种齐全
In Full Range

Note 4. Definition of response time : The response time is defined as the time interval between the 10% and 90% amplitudes.

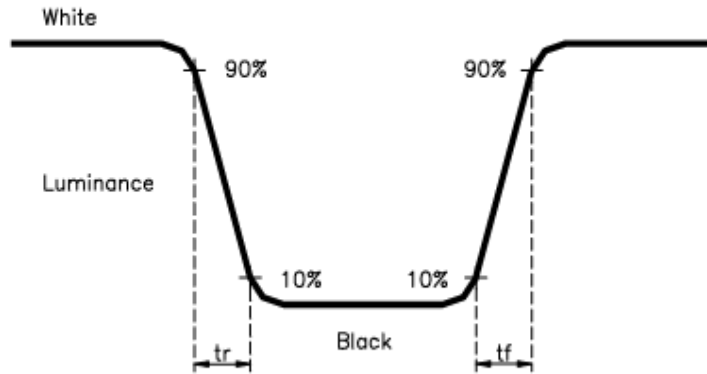

Note 5. Definition of view angle(θ , ψ) :

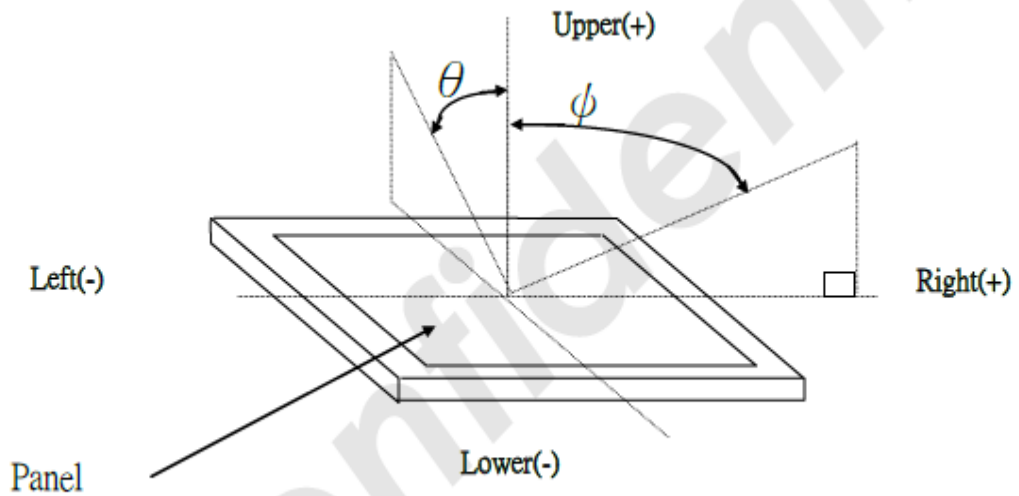

Note 6. Light source: C light.

Part. No	KD043WQTPA035-RT	REV	V1.0	Page 11 of 32
	常备库存 Stock For Sale	长期供货 Long Time supply	支持小量 NO MOQ	品种齐全 In Full Range

5. Electrical Characteristics

5.1 Absolute Maximum Rating (Ta=25 VSS=0V)

Characteristics	Symbol	Min.	Max.	Unit
Digital Supply Voltage	VDD	-0.3	4.6	V
Operating temperature	T _{OP}	-20	+70	°C
Storage temperature	T _{ST}	-30	+80	°C

NOTE: If the absolute maximum rating of even is one of the above parameters is exceeded even momentarily, the quality of the product may be degraded. Absolute maximum ratings, therefore, specify the values exceeding which the product may be physically damaged. Be sure to use the product within the range of the absolute maximum ratings.

5.2 DC Electrical Characteristics

Characteristics	Symbol	Min.	Typ.	Max.	Unit	Note
Digital Supply Voltage	VDD	3.0	3.3	3.6	V	
Normal mode Current consumption	IDD	--	25	--	mA	
Level input voltage	V _{IH}	0.7V _{DD}		V _{DD}	V	
	V _{IL}	GND		0.3V _{DD}	V	
Level output voltage	V _{OH}	V _{DD} -0.4		V _{DD}	V	
	V _{OL}	GND		GND+0.4	V	

5.3 LED Backlight Characteristics

The back-light system is edge-lighting type with 8 chips White LED

Item	Symbol	Min.	Typ.	Max.	Unit	Note
Forward Current	I _F	30	40	--	mA	
Forward Voltage	V _F	--	12.8	--	V	
LCM Luminance	L _V	300	350	--	cd/m ²	Note3
LED life time	Hr	50000	--	--	Hour	Note1,2
Uniformity	AVg	80	--	--	%	Note3

Note (1) LED life time (Hr) can be defined as the time in which it continues to operate under the condition:

T_a=25±3 °C, typical IL value indicated in the above table until the brightness becomes less than 50%.

Note (2) The “LED life time” is defined as the module brightness decrease to 50% original brightness at T_a=25°C and I_L=40mA. The LED lifetime could be decreased if operating I_L is larger than 40mA. The constant current driving method is suggested.

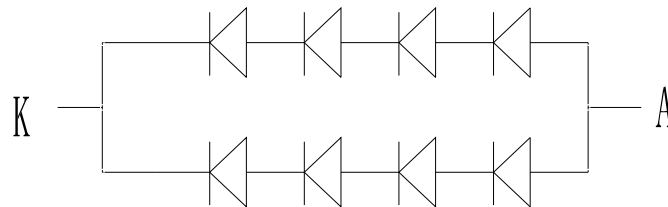

B/L Circuit

NOTE 3: Luminance Uniformity of these 9 points is defined as below:

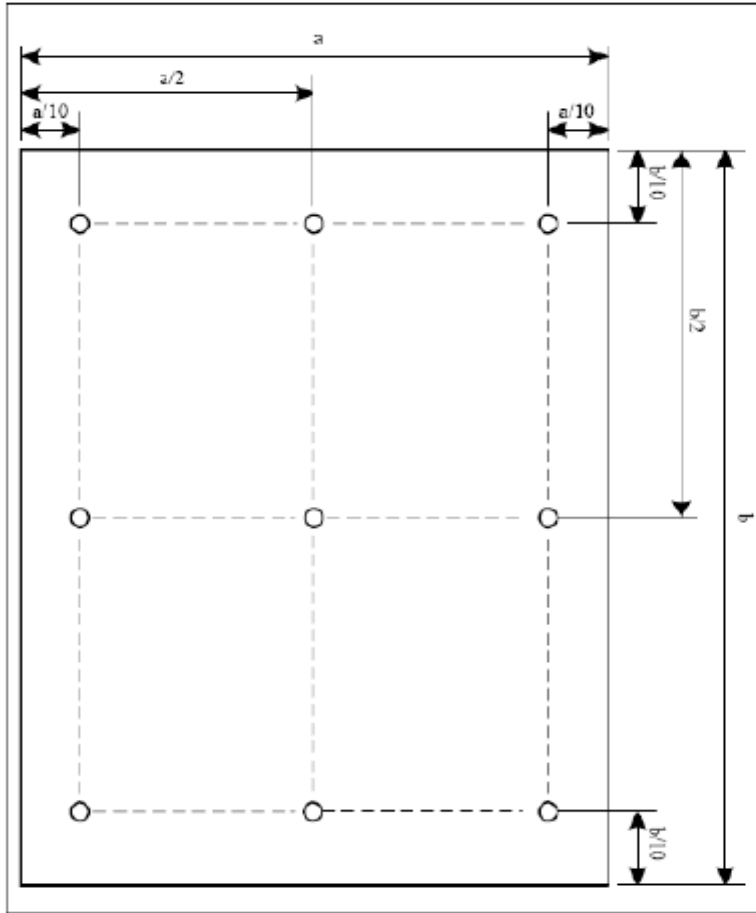

$$\text{Uniformity} = \frac{\text{minimum luminance in 9 points (1-9)}}{\text{maximum luminance in 9 points (1-9)}}$$

$$\text{Luminance} = \frac{\text{Total Luminance of 9 points}}{9}$$

Part. No	KD043WQTPA035-RT	REV	V1.0	Page 14 of 32
	常备库存 Stock For Sale	长期供货 Long Time supply	支持小量 NO MOQ	品种齐全 In Full Range

6. TP Feature

6.1 Conditions of use and storage

Item	Value(condition)	Note
Temperature range upon operation	Humidity: 20%~90% non dew, condensation -20°C~70°C	In a simple substance
Temperature range upon storage	Humidity: 20%~90% non dew, condensation -30°C~80°C	In a simple substance

6.2 Electrical property

Item	Value	Note
Maximum voltage	DC5V	
Resistance between terminals	X direction[Film side]:200-600Ω	
	Y direction [Glass side]:300-900Ω	
Insulation resistance	DC 25V 20MΩor above	Connect X + ~X- and Y+ ~Y-, apply 25VDC Between X and Y for perform measurements
Chattering	10 msec or below	
Rating	Voltage is DC 5V	

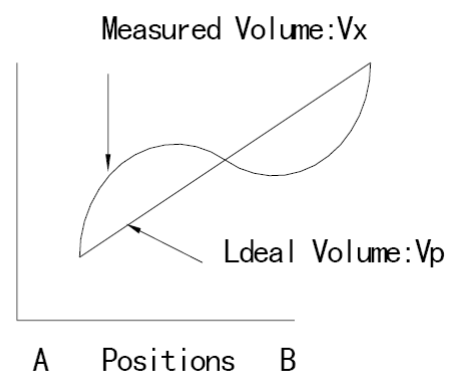
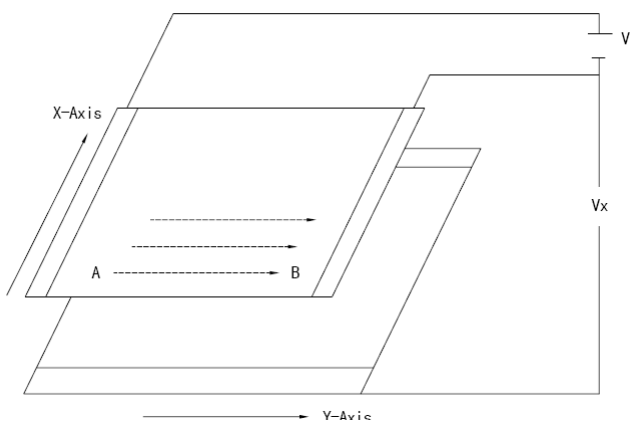

Part. No	KD043WQTPA035-RT	REV	V1.0	Page 15 of 32
----------	------------------	-----	------	---------------

常备库存
Stock For Sale

长期供货
Long Time supply

支持小量
NO MOQ

品种齐全
In Full Range

6.3 Mechanical property

Item	Performance		Note
Input method	Used of an exclusive pen or finger		
Load upon operation	Exclusive pen	60-100g or below	Operation and measurement with a pen must be carried out under the following tip condition s: Stylus pen material : POM(ployacetal) . Tip : Diameter 3.0mm, SR 0.8 mm
	Finger	60-100g or below	Operations and measurement methods simulate d for a finger must be carried out under the fo llowing tip conditions. Material :Silicon rubber (Hardness : 30°Hs) Tip : Diameter 12.0 mm, SR 12.5mm
Surface hardness	Pencil hardness : 3H or above		It complies with the way of test method JIS K5400.

6.4 Optical property

Item	Performance	Note
Total light transmittance	80% or above	JIS K7105
Haze	5% or below	JIS K7136
Film specification	Polished type with hard coated surface	

Part. No	KD043WQTPA035-RT	REV	V1.0	Page 16 of 32
----------	------------------	-----	------	---------------

常备库存
Stock For Sale

长期供货
Long Time supply

支持少量
NO MOQ

品种齐全
In Full Range

7. AC Characteristic

7.1 Input signal characteristics

AC Electrical Characteristics (VDDIO=VDD=3.0 to 3.6v, GND=0V, TA=-20 to +85 °C)

Item	Symbol	Min.	Typ.	Max.	Unit	Conditions
System operation timing						
VDD power source slew time	TPOR	-	-	20	ms	From 0V to 99% VDD
GRB pulse width	tRSTW	10	50	-	us	R=10Kohm, C=1uF
Input/ Output timing						
CLK pulse duty	Tcw	40	50	60	%	
Hsync width	Thw	1	-	-	DCLK	
Hsync period	Th	55	60	65	us	
Vsync setup time	Tvst	12	-	-	ns	
Vsync hold time	Tvhd	12	-	-	ns	
Hsync setup time	Thst	12	-	-	ns	
Hsync hold time	Thhd	12	-	-	ns	
Data setup time	Tdsu	12	-	-	ns	
Data hold time	Tdhd	12	-	-	ns	
SD output stable time	Tst	-	-	12	us	Output settled within +20mV Loading = 6.8k+28.2pF.
GD output rise and fall time	Tgst	-	-	6	us	Output settled (5%~95%), Loading = 4.7k+29.8pF
3-wire serial communication						
Delay between CSB and Vsync	Tcv	1			us	
CS input setup time	Ts0	50			ns	
Serial data input setup time	Ts1	50			ns	
CS input hold time	Th0	50			ns	
Serial data input hold time	Th1	50			ns	
SCL pulse high width	Twh1	50			ns	
SCL pulse low width	Twl1	50			ns	
CS pulse high width	Tw2	400			ns	

Part. No	KD043WQTPA035-RT	REV	V1.0	Page 17 of 32
----------	------------------	-----	------	---------------

常备库存
Stock For Sale

长期供货
Long Time supply

支持小量
NO MOQ

品种齐全
In Full Range

7.2 AC Timing Diagram

7.2.1 Clock and Data Input Timing Diagram

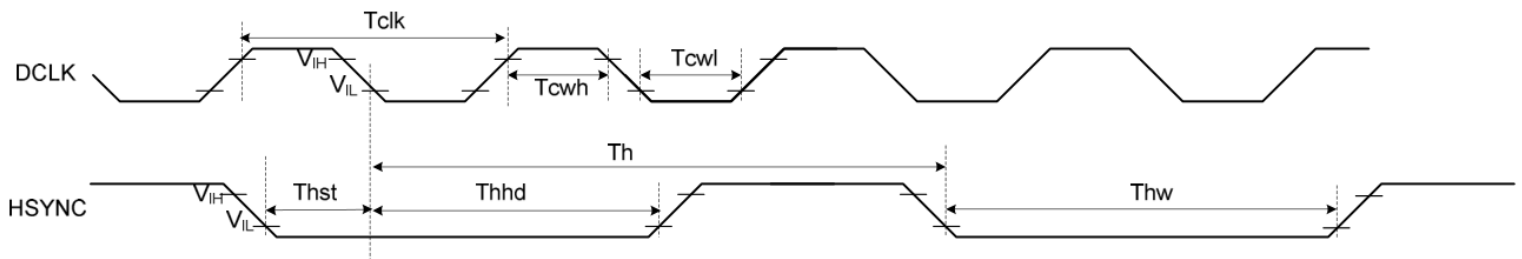
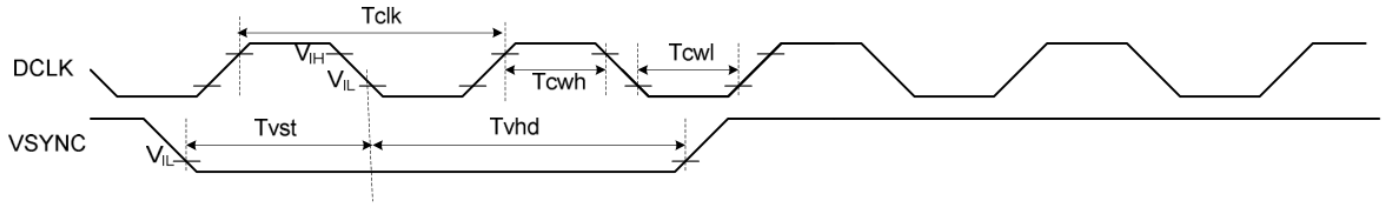

7.2.2 SYNC Mode

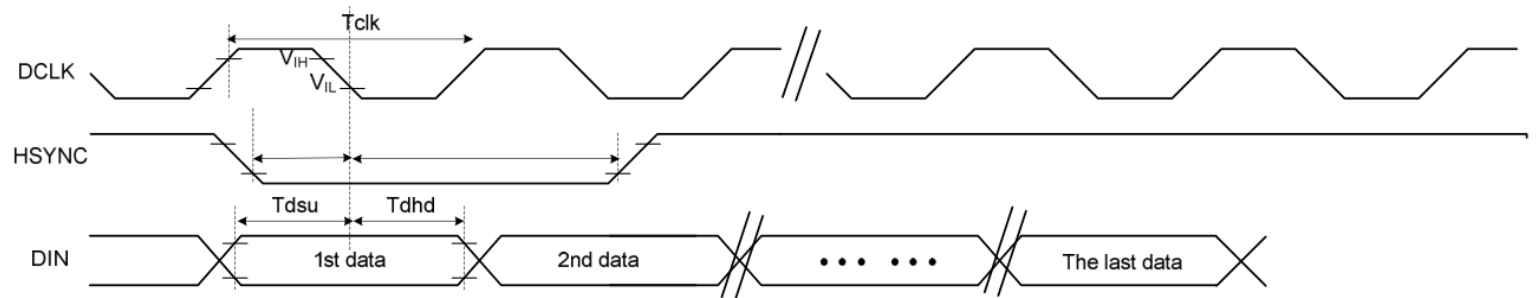

7.2.3 SYNC-DE Mode

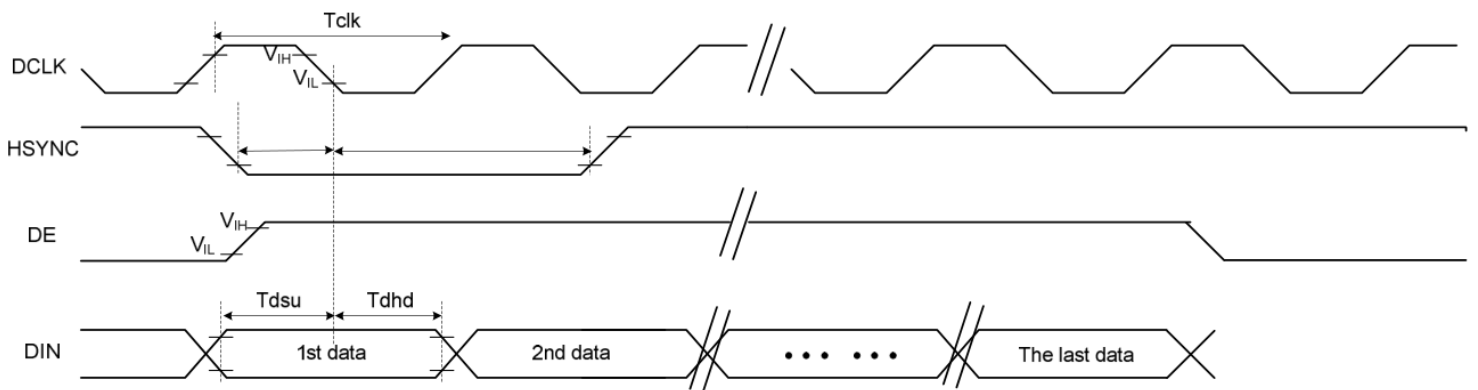

Part. No	KD043WQTPA035-RT	REV	V1.0	Page 18 of 32
----------	------------------	-----	------	---------------

常备库存
Stock For Sale

长期供货
Long Time supply

支持少量
NO MOQ

品种齐全
In Full Range

7.3 3-Wire Communication Timing Diagram

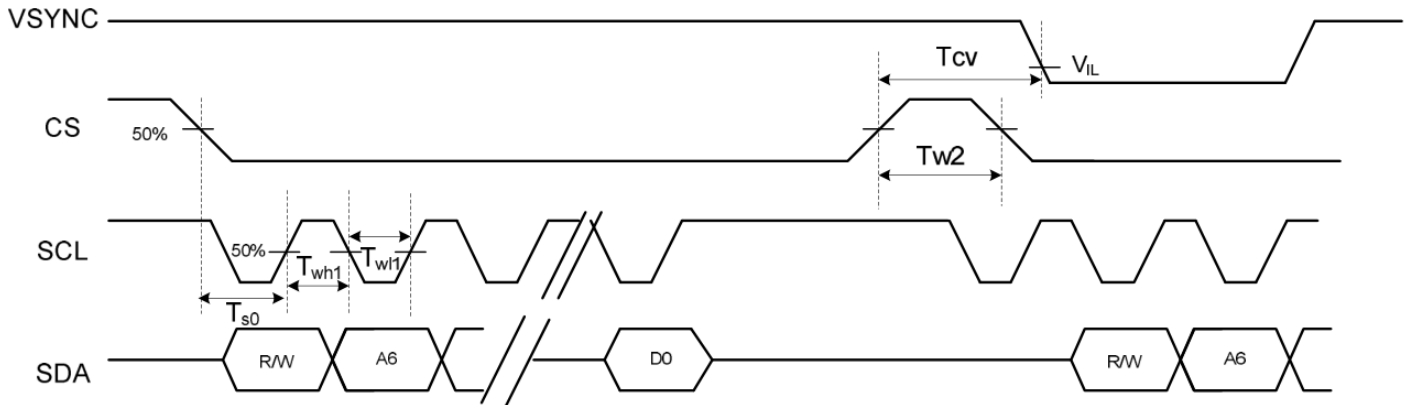

7.4 RGB Input Timing Table

7.4.1 Parallel 24-bit RGB Timing Table

Item	Symbol	Min.	Typ.	Max.	Unit	Remark	
DCLK Frequency	Fclk	8	9	12	MHz		
DCLK Period	Tclk	83	111	125	ns		
HSYNC	Period Time	Th	485	525	532	DCLK	
	Display Period	Thdisp		480		DCLK	
	Back Porch	Thbp	3	43	50	DCLK	By H_Blanking setting
	Front Porch	Thfp	2	2	2	DCLK	
	Pulse Width	Thw	1	1	1	DCLK	
VSYNC	Period Time	Tv	275	285	303	H	
	Display Period	Tvdisp		272		H	
	Back Porch	Tvbp	2	12	30	H	By V_Blanking setting
	Front Porch	Tvfp	1	1	1	H	
	Pulse Width	Tvw	1	1	1	H	

7.4.2 Series 8-bit RGB Timing Table

Item		Symbol	Min.	Typ.	Max.	Unit	Remark
DCLK Frequency		Fclk	24	27	30	MHz	
DCLK Period		Tclk	33	37	42	ns	
HSYNC	Period Time	Th	1560	1716	1900	DCLK	
	Display Period	Thdisp		1440		DCLK	
	Back Porch	Thbp	108	129	255	DCLK	By H_Blanking setting
	Front Porch	Thfp	12	147	205	DCLK	
	Pulse Width	Thw	1	1	50	DCLK	
VSYNC	Period Time	Tv	274	288	335	H	
	Display Period	Tvdisp		272		H	
	Back Porch	Tvbp	1	12	32	H	By V_Blanking setting
	Front Porch	Tvfp	1	4	31	H	
	Pulse Width	Tvw	1	10	30	H	



7.5 SYNC Mode Timing Diagram

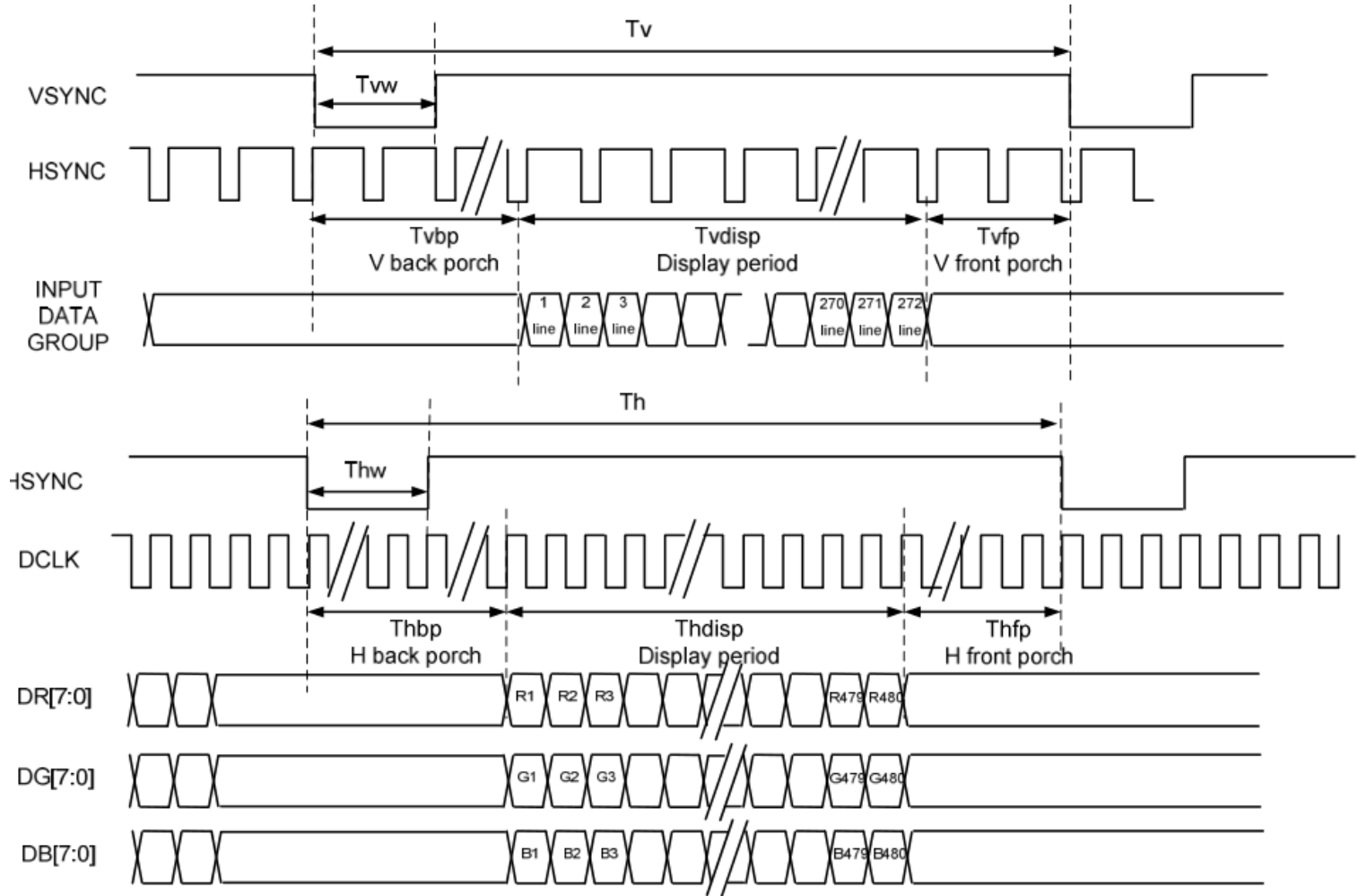

Part. No	KD043WQTPA035-RT	REV	V1.0	Page 21 of 32
----------	------------------	-----	------	---------------

常备库存
Stock For Sale

长期供货
Long Time supply

支持少量
NO MOQ

品种齐全
In Full Range

7.6 SYNC-DE Mode Timing Diagram

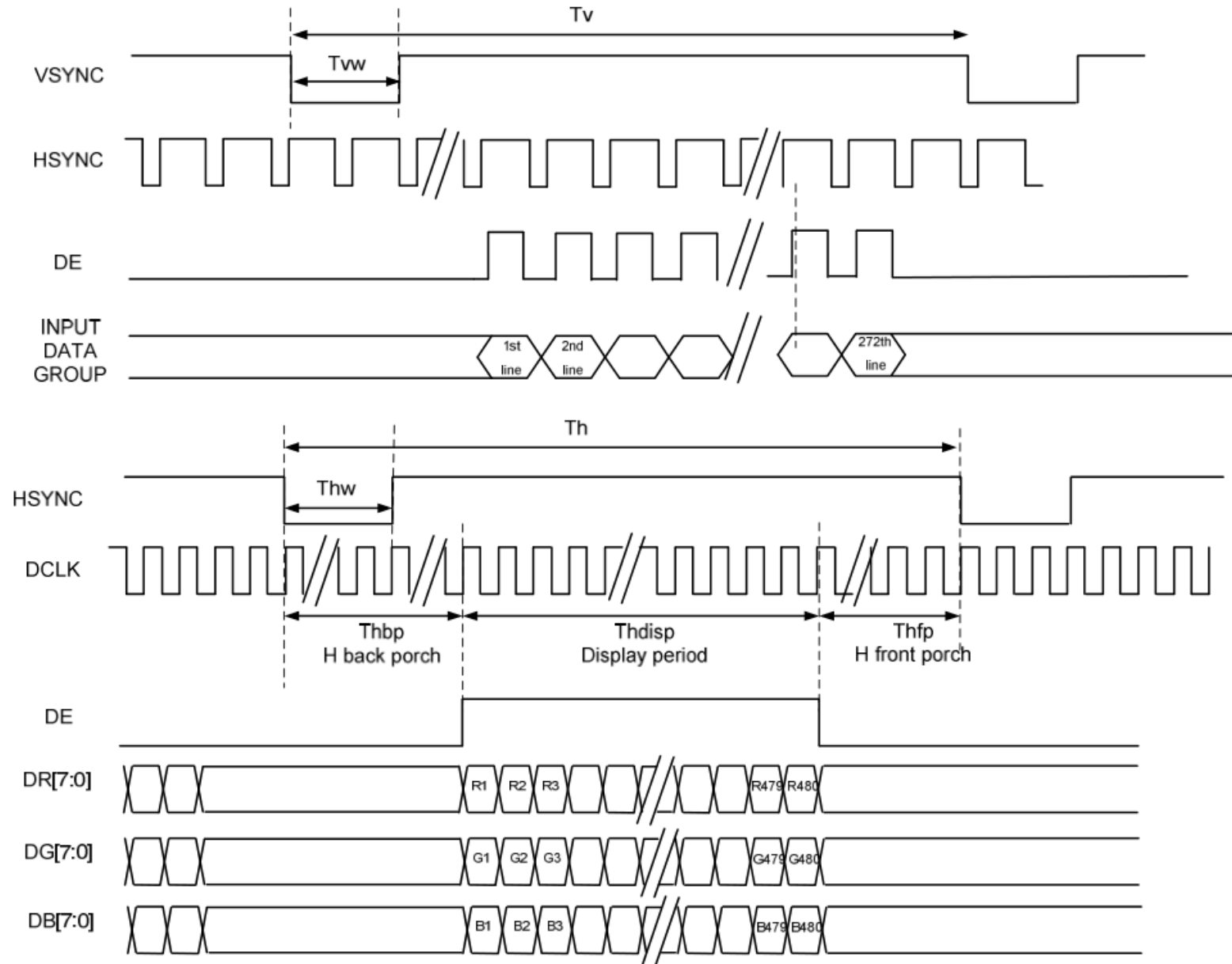

8. LCD Module Out-Going Quality Level

8.1 VISUAL & FUNCTION INSPECTION STANDARD

8.1.1 Inspection conditions

Inspection performed under the following conditions is recommended.

Temperature : 25±5°C

Humidity : 65%±10%RH

Viewing Angle : Normal viewing Angle.

Illumination: Single fluorescent lamp (300 to 700Lux)

Viewing distance:30-50cm

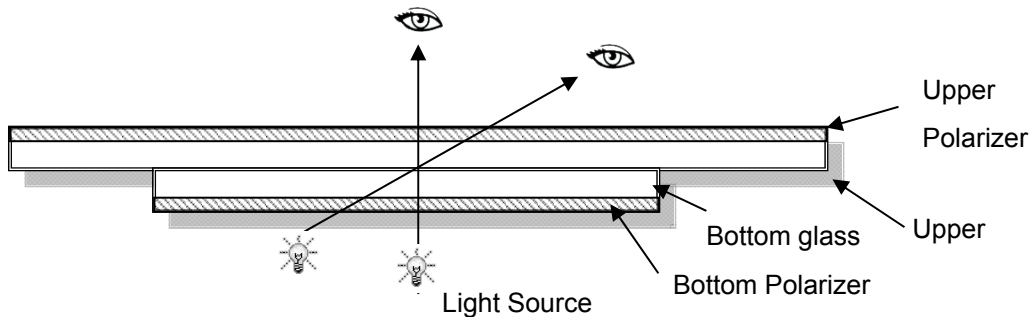

8.1.2 Definition

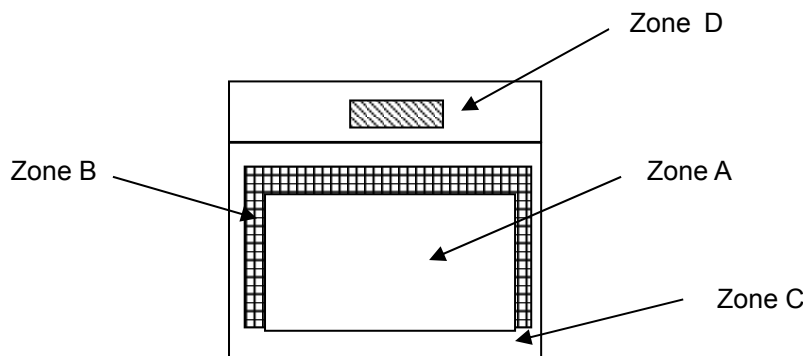

Zone A : Effective Viewing Area(Character or Digit can be seen)

Zone B : Viewing Area except Zone A

Zone C : Outside (Zone A+Zone B) which can not be seen after assembly by customer .)

Zone D : IC Bonding Area

Note:

As a general rule, visual defects in Zone C can be ignored when it doesn't effect product function or appearance after assembly by customer

Part. No	KD043WQTPA035-RT	REV	V1.0	Page 23 of 32
----------	------------------	-----	------	---------------

常备库存
Stock For Sale

长期供货
Long Time supply

支持少量
NO MOQ

品种齐全
In Full Range

8.1.3 Sampling Plan

According to GB/T 2828-2003 ; , normal inspection, Class II

AQL:

Major defect	Minor defect
0.65	1.5

LCD: Liquid Crystal Display , TP: Touch Panel , LCM: Liquid Crystal Module

No	Items to be inspected	Criteria	Classification of defects
1	Functional defects	1) No display, Open or miss line 2) Display abnormally, Short 3) Backlight no lighting, abnormal lighting. 4) TP no function	Major
2	Missing	Missing component	
3	Outline dimension	Overall outline dimension beyond the drawing is not allowed	
4	Color tone	Color unevenness, refer to limited sample	Minor
5	Spot Line defect	Light dot, Dim spot,Polarizer Bubble ; Polarizer accidented spot.	
6	Soldering appearance	Good soldering , Peeling off is not allowed.	
7	LCD/Polarizer/TP	Black/White spot/line, scratch, crack, etc.	

Part. No	KD043WQTPA035-RT	REV	V1.0	Page 24 of 32
----------	------------------	-----	------	---------------

常备库存
Stock For Sale

长期供货
Long Time supply

支持小量
NO MOQ

品种齐全
In Full Range

8.1.4 Criteria (Visual)

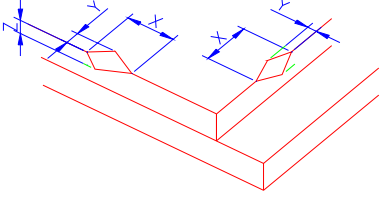
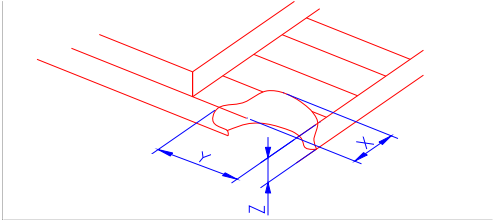
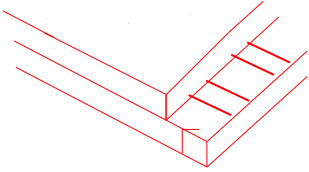
Number	Items	Criteria(mm)						
1.0 LCD Crack/Broken NOTE: X: Length Y: Width Z: Height L: Length of ITO, T: Height of LCD	(1) The edge of LCD broken	 <table border="1" data-bbox="756 667 1455 815"> <thead> <tr> <th>X</th> <th>Y</th> <th>Z</th> </tr> </thead> <tbody> <tr> <td>≤3.0mm</td> <td><Inner border line of the seal</td> <td>≤T</td> </tr> </tbody> </table>	X	Y	Z	≤3.0mm	<Inner border line of the seal	≤T
X	Y	Z						
≤3.0mm	<Inner border line of the seal	≤T						
	(2)LCD corner broken	 <table border="1" data-bbox="836 1124 1375 1223"> <thead> <tr> <th>X</th> <th>Y</th> <th>Z</th> </tr> </thead> <tbody> <tr> <td>≤3.0mm</td> <td>≤L</td> <td>≤T</td> </tr> </tbody> </table>	X	Y	Z	≤3.0mm	≤L	≤T
X	Y	Z						
≤3.0mm	≤L	≤T						
	(3) LCD crack	 <p style="text-align: center;">Crack Not allowed</p>						



2.0	<p>Spot defect</p> <p>$\Phi = (X+Y)/2$</p>	① light dot (LCD/TP/Polarizer black/white spot , light dot, pinhole, dent, stain)																							
		<table border="1"> <thead> <tr> <th rowspan="2">Zone Size (mm)</th> <th colspan="3">Acceptable Qty</th> </tr> <tr> <th>A</th> <th>B</th> <th>C</th> </tr> </thead> <tbody> <tr> <td>$\Phi \leq 0.10$</td> <td colspan="3">Ignore</td> </tr> <tr> <td>$0.10 < \Phi \leq 0.25$</td> <td colspan="3">3(distance $\geq 10\text{mm}$)</td> </tr> <tr> <td>$0.25 < \Phi \leq 0.3$</td> <td colspan="3">2</td> </tr> <tr> <td>$\Phi > 0.35$</td> <td colspan="3">0</td> </tr> </tbody> </table>	Zone Size (mm)	Acceptable Qty			A	B	C	$\Phi \leq 0.10$	Ignore			$0.10 < \Phi \leq 0.25$	3(distance $\geq 10\text{mm}$)			$0.25 < \Phi \leq 0.3$	2			$\Phi > 0.35$	0		
		Zone Size (mm)		Acceptable Qty																					
			A	B	C																				
		$\Phi \leq 0.10$	Ignore																						
$0.10 < \Phi \leq 0.25$	3(distance $\geq 10\text{mm}$)																								
$0.25 < \Phi \leq 0.3$	2																								
$\Phi > 0.35$	0																								
② Dim spot (LCD/TP/Polarizer dim dot, light leakage、 dark spot)																									
<table border="1"> <thead> <tr> <th rowspan="2">Zone Size (mm)</th> <th colspan="3">Acceptable Qty</th> </tr> <tr> <th>A</th> <th>B</th> <th>C</th> </tr> </thead> <tbody> <tr> <td>$\Phi \leq 0.1$</td> <td colspan="3">Ignore</td> </tr> <tr> <td>$0.10 < \Phi \leq 0.25$</td> <td colspan="3">3(distance $\geq 10\text{mm}$)</td> </tr> <tr> <td>$0.25 < \Phi \leq 0.3$</td> <td colspan="3">2</td> </tr> <tr> <td>$\Phi > 0.35$</td> <td colspan="3">0</td> </tr> </tbody> </table>	Zone Size (mm)	Acceptable Qty			A	B	C	$\Phi \leq 0.1$	Ignore			$0.10 < \Phi \leq 0.25$	3(distance $\geq 10\text{mm}$)			$0.25 < \Phi \leq 0.3$	2			$\Phi > 0.35$	0				
Zone Size (mm)		Acceptable Qty																							
	A	B	C																						
$\Phi \leq 0.1$	Ignore																								
$0.10 < \Phi \leq 0.25$	3(distance $\geq 10\text{mm}$)																								
$0.25 < \Phi \leq 0.3$	2																								
$\Phi > 0.35$	0																								
③ Polarizer accidented spot																									
<table border="1"> <thead> <tr> <th rowspan="2">Zone Size (mm)</th> <th colspan="3">Acceptable Qty</th> </tr> <tr> <th>A</th> <th>B</th> <th>C</th> </tr> </thead> <tbody> <tr> <td>$\Phi \leq 0.2$</td> <td colspan="3">Ignore</td> </tr> <tr> <td>$0.3 < \Phi \leq 0.5$</td> <td colspan="3">2(distance $\geq 10\text{mm}$)</td> </tr> <tr> <td>$\Phi > 0.5$</td> <td colspan="3">0</td> </tr> </tbody> </table>	Zone Size (mm)	Acceptable Qty			A	B	C	$\Phi \leq 0.2$	Ignore			$0.3 < \Phi \leq 0.5$	2(distance $\geq 10\text{mm}$)			$\Phi > 0.5$	0								
Zone Size (mm)		Acceptable Qty																							
	A	B	C																						
$\Phi \leq 0.2$	Ignore																								
$0.3 < \Phi \leq 0.5$	2(distance $\geq 10\text{mm}$)																								
$\Phi > 0.5$	0																								
④ Pixel bad points (light dot, Dim dot, color dot)																									
<table border="1"> <thead> <tr> <th rowspan="2">Zone Size (mm)</th> <th colspan="3">Acceptable Qty</th> </tr> <tr> <th>A</th> <th>B</th> <th>C</th> </tr> </thead> <tbody> <tr> <td>$\Phi \leq 0.1$</td> <td colspan="3">Ignore</td> </tr> <tr> <td>$0.15 < \Phi \leq 0.25$</td> <td colspan="3">2(distance $\geq 10\text{mm}$)</td> </tr> <tr> <td>$\Phi > 0.3$</td> <td colspan="3">0</td> </tr> </tbody> </table>	Zone Size (mm)	Acceptable Qty			A	B	C	$\Phi \leq 0.1$	Ignore			$0.15 < \Phi \leq 0.25$	2(distance $\geq 10\text{mm}$)			$\Phi > 0.3$	0								
Zone Size (mm)		Acceptable Qty																							
	A	B	C																						
$\Phi \leq 0.1$	Ignore																								
$0.15 < \Phi \leq 0.25$	2(distance $\geq 10\text{mm}$)																								
$\Phi > 0.3$	0																								
⑤ Polarizer Bubble																									
<table border="1"> <thead> <tr> <th rowspan="2">Zone Size (mm)</th> <th colspan="3">Acceptable Qty</th> </tr> <tr> <th>A</th> <th>B</th> <th>C</th> </tr> </thead> <tbody> <tr> <td>$\Phi \leq 0.2$</td> <td colspan="3">Ignore</td> </tr> <tr> <td>$0.3 < \Phi \leq 0.4$</td> <td colspan="3">3(distance $\geq 10\text{mm}$)</td> </tr> <tr> <td>$0.4 < \Phi \leq 0.5$</td> <td colspan="3">2</td> </tr> <tr> <td>$\Phi > 0.5$</td> <td colspan="3">0</td> </tr> </tbody> </table>	Zone Size (mm)	Acceptable Qty			A	B	C	$\Phi \leq 0.2$	Ignore			$0.3 < \Phi \leq 0.4$	3(distance $\geq 10\text{mm}$)			$0.4 < \Phi \leq 0.5$	2			$\Phi > 0.5$	0				
Zone Size (mm)		Acceptable Qty																							
	A	B	C																						
$\Phi \leq 0.2$	Ignore																								
$0.3 < \Phi \leq 0.4$	3(distance $\geq 10\text{mm}$)																								
$0.4 < \Phi \leq 0.5$	2																								
$\Phi > 0.5$	0																								

3.0	Line defect (LCD/TP /Polarizer backlight black/white line, scratch, stain)	Width(mm)	Length(m m)	Acceptable Qty		
				A	B	C
		$\Phi \leq 0.05$	Ignore	Ignore		
		$0.05 < W \leq 0.06$	$L \leq 3.0$	$N \leq 2$		
		$0.07 < W \leq 0.08$	$L \leq 2.0$	$N \leq 1$		
		$0.08 < W$	Define as spot defect			
4.0	Electronic Comp onents SMT	Not allow missing parts, solderless connection, cold solder joint, mis match, The positive and negative polarity opposite				
5.0	Display color& B rightness	<p>1. Color: Measuring the color coordinates, The measurement standar d according to the datasheet or samples.</p> <p>2. Brightness: Measuring the brightness of White screen, The measu rement standard according to the datasheet or Samples.</p>				
6.0	LCD Mura	By 5% ND filter invisible.				

7.0	RTP Related	TP film bubble/ accidented spot	Size Φ (mm)	Acceptable Qty		
				A	B	C
			$\Phi \leq 0.1$	Ignore		
			$0.1 < \Phi \leq 0.2$	3 (distance ≥ 10 mm)		
			$0.25 < \Phi \leq 0.3$	2		
		$\Phi > 0.35$	0			
			Ignore			



Part. No	KD043WQTPA035-RT	REV	V1.0	Page 27 of 32
----------	------------------	-----	------	---------------

常备库存
Stock For Sale

长期供货
Long Time supply

支持小量
NO MOQ

品种齐全
In Full Range

TP film scratch	Width(mm)	Length(mm)	Acceptable Qty		
	$\Phi \leq 0.05$	Ignore	A	B	C
	$0.05 < W \leq 0.06$	$L \leq 3.0$	Ignore		Ignore
	$0.07 < W \leq 0.08$	$L \leq 2.0$	N \leq 2		
$0.08 < W$	Define as spot defect				
Assembly deflection	beyond the edge of backlight $\leq 0.2\text{mm}$				
Bulge (undulation included)	The ITO film plumped below 0.40mm, it's ok.				
					
Newton Ring	Newton Ring area $> 1/3$ TP area NG Newton Ring area $\leq 1/3$ TP area OK				

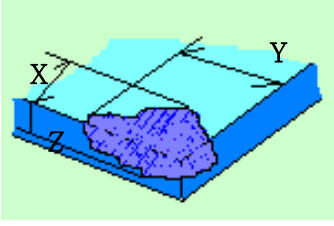
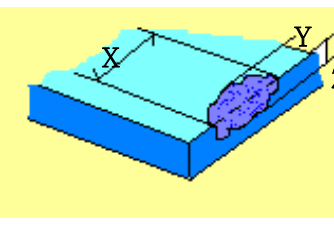
		TP corner broken X : length Y : width Z : height	<table border="1"> <tr> <td>X</td> <td>Y</td> <td>Z</td> </tr> <tr> <td>X≤3mm</td> <td>Y≤3mm</td> <td>Z<COVER thickness s</td> </tr> </table> <p>*Circuitry broken is not allowed.</p>	X	Y	Z	X≤3mm	Y≤3mm	Z<COVER thickness s	
		X	Y	Z						
X≤3mm	Y≤3mm	Z<COVER thickness s								
TP edge broken X : length Y : width Z : height	<table border="1"> <tr> <td>X</td> <td>Y</td> <td>Z</td> </tr> <tr> <td>X≤4mm</td> <td>Y≤2mm</td> <td>Z<COVER thickness</td> </tr> </table> <p>* Circuitry broken is not allowed.</p>	X	Y	Z	X≤4mm	Y≤2mm	Z<COVER thickness			
X	Y	Z								
X≤4mm	Y≤2mm	Z<COVER thickness								

Criteria (functional items)

Number	Items	Criteria (mm)
1	No display	Not allowed
2	Missing segment	Not allowed
3	Short	Not allowed
4	Backlight no lighting	Not allowed
5	TP no function	Not allowed

9. Reliability Test Result

Item	Condition	Inspection after test
High Temperature Operating	70℃,96H	Inspection after 2~4hours storage at room temperature, the sample shall be free from defects: 1.Air bubble in the LCD; 2.Non-display; 3.Missing segments/line; 4.Glass crack; 5.Current IDD is twice higher than initial value.
Low Temperature Operating	-20℃, 96HR	
High Temperature Storage	80℃, 96HR	
Low Temperature Storage	-30℃, 96HR	
High Temperature & High Humidity Operating	+60℃, 90% RH ,96 hours.	
Thermal Shock (Non-operation)	-30℃,30 min ↔ 80℃,30 min, Change time:5min 20CYC.	
ESD test	C=150pF, R=330,5points/panel Air:±8KV, 5times; Contact:±6KV, 5 times; (Environment: 15℃~35℃, 30%~60%).	
Vibration (Non-operation)	Frequency range:10~55Hz, Stroke:1.5mm Sweep:10Hz~55Hz~10Hz 2 hours for each direction of X.Y.Z. (6 hours for total) (Package condition).	
Box Drop Test	1 Corner 3 Edges 6 faces,80cm(MEDIUM BOX)	

Remark:

- 1.The test samples should be applied to only one test item.
- 2.Sample size for each test item is 5~10pcs.
- 3.For Damp Proof Test, Pure water(Resistance > 10MΩ) should be used.
- 4.In case of malfunction defect caused by ESD damage, if it would be recovered to normal state after resetting, it would be judged as a good part.
- 5.Failure Judgment Criterion: Basic Specification, Electrical Characteristic, Mechanical Characteristic, Optical Characteristic.

Part. No	KD043WQTPA035-RT	REV	V1.0	Page 30 of 32
----------	------------------	-----	------	---------------

常备库存
Stock For Sale

长期供货
Long Time supply

支持少量
NO MOQ

品种齐全
In Full Range

10. Cautions and Handling Precautions

10.1 Handling and Operating the Module

- (1) When the module is assembled, it should be attached to the system firmly.
Do not warp or twist the module during assembly work.
- (2) Protect the module from physical shock or any force. In addition to damage, this may cause improper operation or damage to the module and back-light unit.
- (3) Note that polarizer is very fragile and could be easily damaged. Do not press or scratch the surface.
- (4) Do not allow drops of water or chemicals to remain on the display surface.
If you have the droplets for a long time, staining and discoloration may occur.
- (5) If the surface of the polarizer is dirty, clean it using some absorbent cotton or soft cloth.
- (6) The desirable cleaners are water, IPA (Isopropyl Alcohol) or Hexane.
Do not use ketene type materials (ex. Acetone), Ethyl alcohol, Toluene, Ethyl acid or Methyl chloride. It might permanent damage to the polarizer due to chemical reaction.
- (7) If the liquid crystal material leaks from the panel, it should be kept away from the eyes or mouth. In case of contact with hands, legs, or clothes, it must be washed away thoroughly with soap.
- (8) Protect the module from static; it may cause damage to the CMOS ICs.
- (9) Use finger-stalls with soft gloves in order to keep display clean during the incoming inspection and assembly process.
- (10) Do not disassemble the module.
- (11) Protection film for polarizer on the module shall be slowly peeled off just before use so that the electrostatic charge can be minimized.
- (12) Pins of I/F connector shall not be touched directly with bare hands.
- (13) Do not connect, disconnect the module in the "Power ON" condition.
- (14) Power supply should always be turned on/off by the item 6.1 Power On Sequence & 6.2 Power Off Sequence

10.2 Storage and Transportation.

- (1) Do not leave the panel in high temperature, and high humidity for a long time.
It is highly recommended to store the module with temperature from 0 to 35 °C and relative humidity of less than 70%
- (2) Do not store the TFT-LCD module in direct sunlight.
- (3) The module shall be stored in a dark place. When storing the modules for a long time, be sure to adopt effective measures for protecting the modules from strong ultraviolet radiation, sunlight, or fluorescent light.
- (4) It is recommended that the modules should be stored under a condition where no condensation is allowed. Formation of dewdrops may cause an abnormal operation or a failure of the module.
In particular, the greatest possible care should be taken to prevent any module from being operated where condensation has occurred inside.
- (5) This panel has its circuitry FPC on the bottom side and should be handled carefully in order not to be stressed.

Part. No	KD043WQTPA035-RT	REV	V1.0	Page 31 of 33
----------	------------------	-----	------	---------------

常备库存
Stock For Sale

长期供货
Long Time supply

支持小量
NO MOQ

品种齐全
In Full Range

11. Packing

---TBD-----

Part. No	KD043WQTPA035-RT	REV	V1.0	Page 32 of 32
	常备库存 Stock For Sale	长期供货 Long Time supply	支持小量 NO MOQ	品种齐全 In Full Range