

# CLUX-22HC

## HDMI/CAT6 to HDMI/ CAT6 Splitter Switcher

### Operation Manual

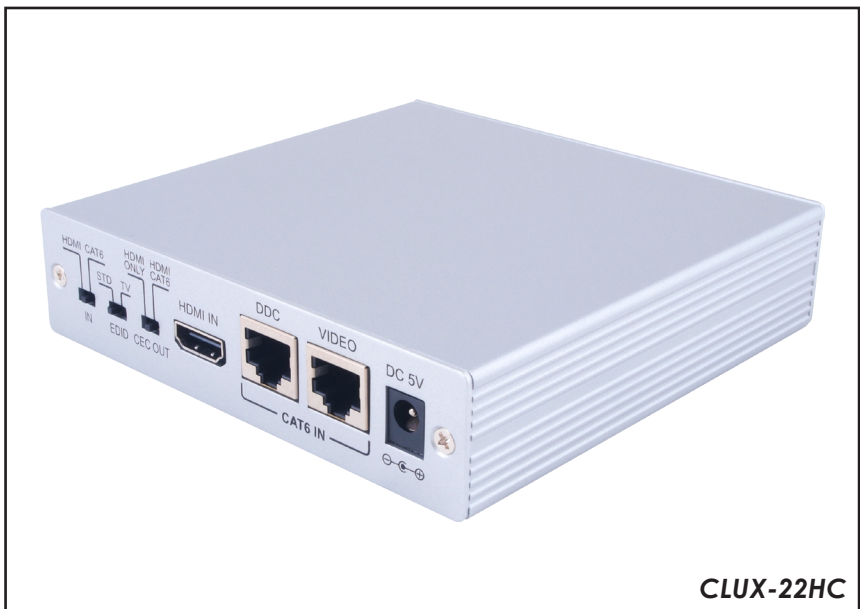

CLUX-22HC

Vertrieb durch  
Distribution by

**HY-LINE**<sup>®</sup>  
COMPUTER COMPONENTS  
Inselkammerstr. 10  
D-82008 Unterhaching  
Tel.: +49 89 614 503 40  
www.hy-line.de

Vertrieb durch  
Distribution by **HY-LINE®**  
COMPUTER COMPONENTS  
Inselkammerstr. 10  
D-82008 Unterhaching  
Tel.: +49 89 614 503 40  
[www.hy-line.de](http://www.hy-line.de)

## • **Disclaimers**

The information in this manual has been carefully checked and is believed to be accurate. Cypress Technology assumes no responsibility for any infringements of patents or other rights of third parties which may result from its use.

Cypress Technology assumes no responsibility for any inaccuracies that may be contained in this document. Cypress also makes no commitment to update or to keep current the information contained in this document.

Cypress Technology reserves the right to make improvements to this document and/or product at any time and without notice.

## • **Copyright Notice**

No part of this document may be reproduced, transmitted, transcribed, stored in a retrieval system, or any of its part translated into any language or computer file, in any form or by any means - electronic, mechanical, magnetic, optical, chemical, manual, or otherwise - without express written permission and consent from Cypress Technology.

© Copyright 2009 by Cypress Technology.

All Rights Reserved.

Version 1.0 December 2009

## • **Trademark Acknowledgments**

All products or service names mentioned in this document may be trademarks of the companies with which they are associated.

## • **Safety Precautions**

Please read all instructions before attempting to unpack or install or operate this equipment, and before connecting the power supply. Please keep the following in mind as you unpack and install this equipment:

- Always follow basic safety precautions to reduce the risk of fire, electrical shock and injury to persons.
- To prevent fire or shock hazard, do not expose the unit to rain, moisture or install this product near water.
- Never spill liquid of any kind on or into this product.
- Never push an object of any kind into this product through module openings or empty slots, as you may damage parts.
- Do not attach the power supply cabling to building surfaces.
- Do not allow anything to rest on the power cabling or allow it to be abused by persons walking on it.
- To protect the equipment from overheating, do not block the slots and openings in the module housing that provide ventilation.

## • **Revision History**

<b>Version No</b>	<b>Date</b>	<b>Summary of Change</b>
<b>V1</b>	<b>20091208</b>	<b>Preliminary Release</b>
<b>V2</b>	<b>20101116</b>	<b>IR Connection in Pg. 7</b>
<b>VR3</b>	<b>20120416</b>	<b>IR Frequency</b>

Vertrieb durch  
Distribution by

**HY-LINE®**  
COMPUTER COMPONENTS  
Inselkammerstr. 10  
D-82008 Unterhaching  
Tel.: +49 89 614 503 40  
www.hy-line.de

# Table of Contents

1.	Introduction.....	1
2.	Applications.....	1
3.	Package Contents.....	1
4.	System Requirements.....	1
5.	Features.....	2
6.	Specifications.....	3
7.	Operation Controls and Functions.....	4
	7.1 Front Panel .....	4
	7.2 Rear Panel.....	5
8.	RJ-45 Pin Definitions .....	6
9.	Connection and Installation.....	7
10.	Acronyms.....	9

## 1. Introduction

The HDMI/CAT6 to HDMI/CAT6 Splitter Switcher is the most advanced solution for HDMI and Video/DDC signal distribution. This CAT6 output port can be easily connected to an HDMI receivers CAT6 input port to allow a stable connection between an HDMI source and any compatible display. Each product in this series is compatible to HDMI V1.3, which defines and supports the transfer of Deep Color (10bit and 12bit) video and a new lossless compressed (Dolby TrueHD, Dolby Digital Plus and DTS-HD Master Audio) digital audio signal, with a high bandwidth up to 225MHz (6.75Gbps). Besides splitting and distributing, the Video/DDC CAT6 output also does signal amplification and equalization which provide high performance I/O of audio and video.

## 2. Applications

- Home entertainment integration
- Multi-task project presentation
- Showroom Display
- Advertising display control
- System installation control

## 3. Package Contents

- 1 x HDMI/CAT6 to HDMI/CAT6 Splitter Switcher
- 5V DC power supply adaptor
- User Manual

## 4. System Requirements

- Input source equipment(s) with HDMI cable and or HDMI to CAT6 transmitter
- Output display(s) with HDMI cable and or CAT6 to HDMI receiver with HDMI cable to display

## 5. Features

- HDMI 1.3, HDCP1.1 and DV11.0 compliant.
- Deep color video up to 12bit, 1080p@(24/60)Hz.
- Simultaneously outputs one HDMI and one Video/DDC CAT6 source to one HDMI and one Video/DDC CAT6 output.
- HDCP keysets allows each output to work independently when connecting to an HDMI display.
- Capable of splitting HDMI/CAT6 sources to HDMI/CAT6 outputs without any signal loss.
- Supports LPCM7.1CH, Dolby TrueHD, Dolby Digital Plus and DTS-HD master audio transmission (32-192 kHz Fs sample rate).
- Supports a wide range of PC and HDTV resolutions from VGA to SXGA and 480i to 1080p.
- Full HDCP Compliant.
- According to tests The Input/Output source can be up to 15/15 meters away when the HDMI cable has a resolution of with 1080p/8bits. The CAT6 cable test showed that with a resolution of 1080p/8bits, the Input/Output source can be 45/45 meters away. The HDMI cable test showed that with a resolution of 1080p/12bits, the Input/Output source can be 15/10 meters away. And finally the CAT6 cable test showed that with a resolution of 1080p/12bits, the Input/Output source can be 20/20 meters away

## 6. Specifications

Video Bandwidth	2.25MHz/6.75Gbps
Input Ports	1 x HDMI female port (Type A connector) 1 x CAT6 input Video/1 x CAT6 input DDC
Output Ports	1 x CAT6 output Video/1 x CAT6 output DDC 1 x HDMI female ports (Type A connector)
EDID	STD / TV
HDMI Audio Output	PCM2, 5.1, 7.1, Dolby 5.1, DTS 5.1, DD+, D-TrueHD, DTS-HD
HDMI Cable In	1080p 8-bit (15M), 12-bit (15M)
HDMI Cable Out	1080p 8-bit (15M), 12-bit (10M)
CAT6 Cable In	1080p 8-bit (45M), 12-bit (20M)
CAT6 Cable Out	1080p 8-bit (45M), 12-bit (20M)
HDMI Resolution	480i, ~ 1080p 50/60, 1080p 24, VGA ~ SXGA
IR Frequency	30 ~ 50KHz
ESD Protection	Human body model: $\pm 8kV$ (air-gap discharge) $\pm 4kV$ (contact discharge)
Power Supply	5VDC/3.2A (US/EU standards, CE/FCC/UL certified)
Dimensions (mm)	215(W) x123(D) x 30(H)
Weight(g)	365
Chassis Material	Metal
Silkscreen Color	Silver
Power Consumption	4.1 W
Operating Temperature	0°C ~ 40°C / 32°F ~ 104°F
Storage Temperature	-20°C ~ 60°C / -4°F ~ 140°F
Relative Humidity	20~90% RH (non- condensing)



## 7. Operation Controls and Functions

The following sections describe the hardware components of the unit.

### 7.1 Front Panel

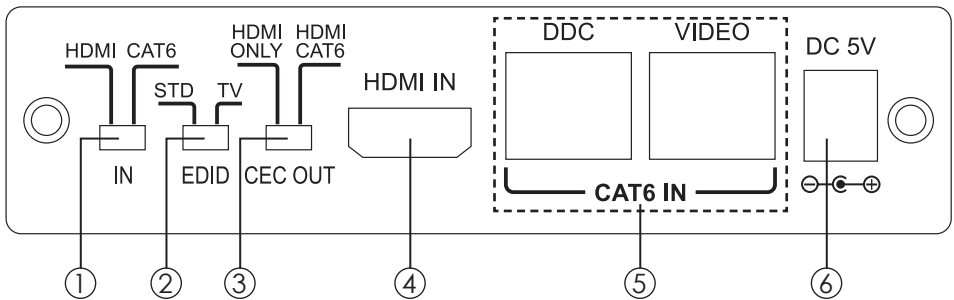

- ① HDMI/CAT6 input selection: Switch to select input sources from either HDMI or CAT6.
- ② EDID Control Switcher: The default factory setting is TV, do not switch if the display is compatible. Switch to STD to use built-in EDID.

#### **[Note]:**

1. When EDID is switched to TV, the unit will detect and record the first HDMI's output EDID in the unit. If the first detected HDMI output is DVI it will continue to pass on to the next output until the first HDMI output is found. The detection priority is HDMI v1.3 > HDMI v1.2 > DVI.
2. When EDID is switched to STD the unit will use its own EDID which supports:  
Video → 1080p 8-bit (max)  
Audio → PCM 2CH
3. When EDID is switched to STD with input selection on HDMI or CAT6 IN the display TV or monitor, they will automatically switch to HDMI input 1. When EDID is switched to TV regardless of the input selection the display TV or monitor will switch to HDMI input mode 1. Therefore it is not suggested to switch the EDID to STD.
4. The EDID selection will activate only when the unit is plugged in and power is on.
- ③ CEC output: Only when switched to HDMI, the HDMI's output port CEC will bypass the CEC and proceed directly to the HDMI and CAT6 input ports. When switched to HDMI and CAT6, the HDMI and CAT6 output ports CEC will bypass the CEC and go proceed directly to the HDMI.
- ④ HDMI Input: Connect input port to the HDMI or DVI output port of your

source equipment such as DVD player or set-top-box.

- ⑤ CAT6 IN: These slots are for connecting the Video/DDC input to the Video/DDC output of the transmitter unit with CAT6 cables.

**[Note]:**

- 1. Cable tested with CAT6 / 23AWG / was solid, so any cables with different specifications might result in a different distance.
  - 2. The cable distance was tested with a PS3 40G and 37" SamSung 12 bits LCD TV.
  - 3. The figures provided in this manual are for reference use only, actual results depend on your specific configuration, i.e.: your source and display and type of cabling used.
- ⑥ DC 5V: This is the slot where you insert the 5V DC power supply for electrical power before plugging the adaptor into an AC wall outlet.

**7.2 Rear Panel**

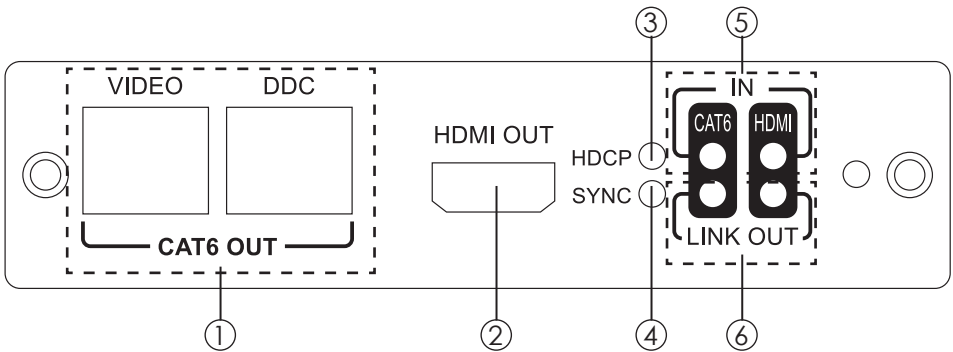

- ① CAT6 OUT: Connect the Video/DDC output to the Video/DDC input of the receiver unit using CAT6 cables.
- ② HDMI OUT: Connect HDMI output port to the HDMI display.
- ③ HDCP indicators: When the input source has HDCP protection the HDCP LED will turn on.
- ④ The LED light will turn when the HDMI or DVI source has been connected.
- ⑤ HDMI/CAT6 input indicator: The LED light will turn on when the HDMI or CAT6 source has been selected.
- ⑥ Link OUT: The LED light will turn on when the display has been connected.

## 8. RJ-45 Pin Definitions

Pin	Video	DDC
1	TX2+	DDC Bus Clock
2	TX2-	NC
3	TX1+	DDC Bus Data
4	TX0+	Power 5V
5	TX0-	GND
6	TX1-	IR IN
7	TXC+	HPD
8	TXC-	CEC

# 9. Connection and Installation

CH-106TX  
CH-1106TX

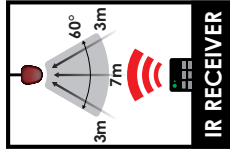
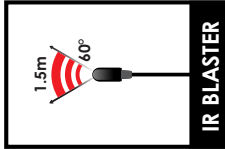
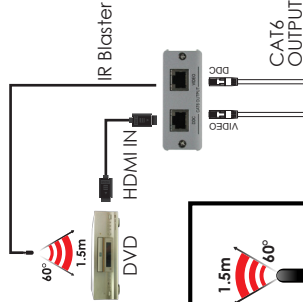

A or B or C

CLUX-1H4CAT  
CLUX-1H8CAT

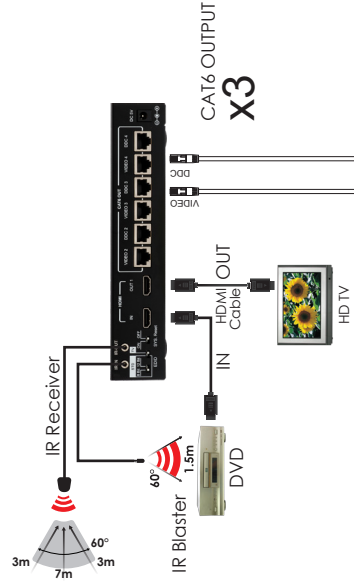

A or B or C

CLUX-22HC



CH-106TX  
CH-1106TX  
CLUX-1H4CAT  
CLUX-1H8CAT  
CMLUX-4H4CAT  
CLUX-22HC

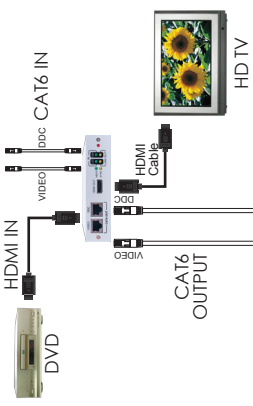

A or B or C

### A CH-1106RX / CH-1106RX

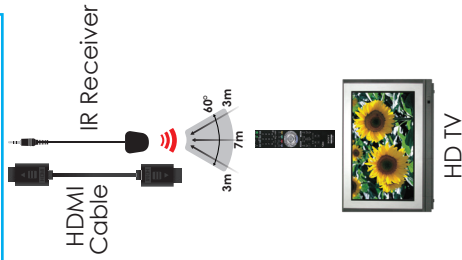

### B CLUX-1CAT4H / CLUX-1CAT8H

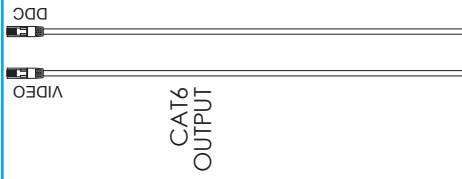

### C CLUX-22HC

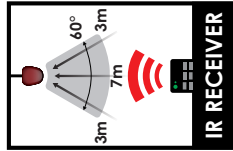
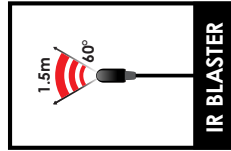
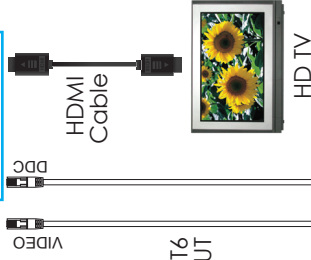

A or B or C

A or B or C



# Acronyms

---

<b>Acronym</b>	<b>Complete Term</b>
CAT6	Category 6 cable
DVI	Digital Visual Interface
EDID	Extended Display Identification Data
HDCP	High-Bandwidth Digital Content Protection
HDMI	High-Definition Multimedia Interface
HDTV	High-Definition Television
IR	Infrared
LPCM	Linear Pulse Code Modulation
STD	Standard
SYNC	Synchronize
SXGA	Super Extended Graphics Array
VGA	Video Graphics Array





**CYPRESS TECHNOLOGY CO., LTD.**  
Home page: <http://www.cypress.com.tw>

20091217 MPM-CLUX22HC