



Ihr Vertriebspartner:

HY-LINE[®]
POWER COMPONENTS

Inselkammerstraße 10
D-82008 Unterhaching
Tel: +49 (0)89 614 503 10
Fax: +49 (0)89 614 503 20
E-Mail: power@hy-line.de
www.hy-line.de

Hochstraße 355
CH-8200 Schaffhausen
Tel: +41 (0)52 647 42 00
Fax: +41 (0)52 647 42 01
E-Mail: power@hy-line.ch
www.hy-line.ch

Selection Guide

Analog Integrations Corporation

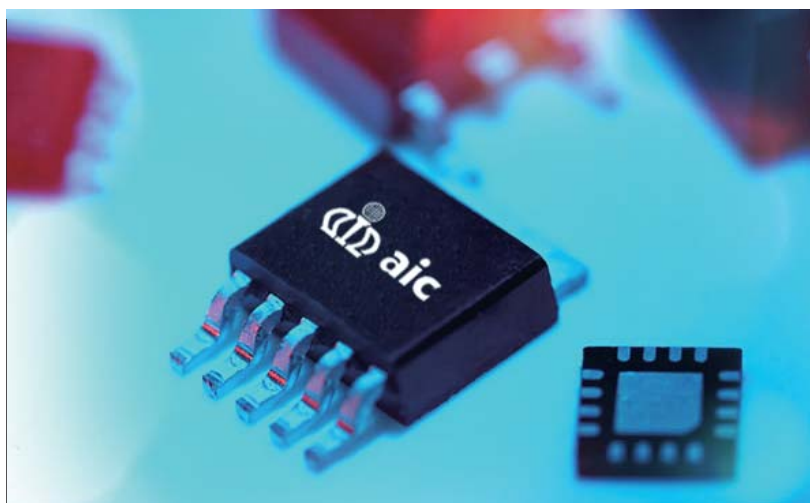

2017.1



INDEX

Quick Reference

■ Quick Reference - Power Conversion	P.1
■ Quick Reference - Power Manipulation	P.2
■ Quick Reference - Power Selection Table	P.3

Selection Guide

■ Portable Power Application	P.4
■ High Power Application	P.6
■ White-LED Drivers	P.6
■ Power Switch	P.8
■ Supervisory	P.8
■ Miscellaneous	P.8
■ Linear Voltage Regulators & Voltage Reference	P.9

DC/DC Converter for Portable Application p4

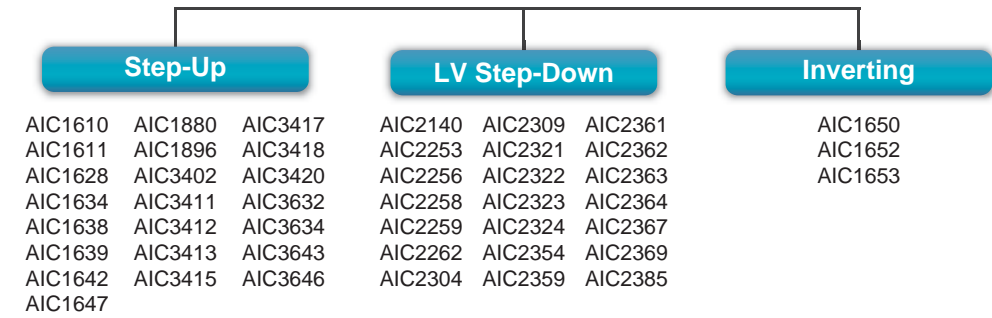

DC/DC Converter for High Power Application p6

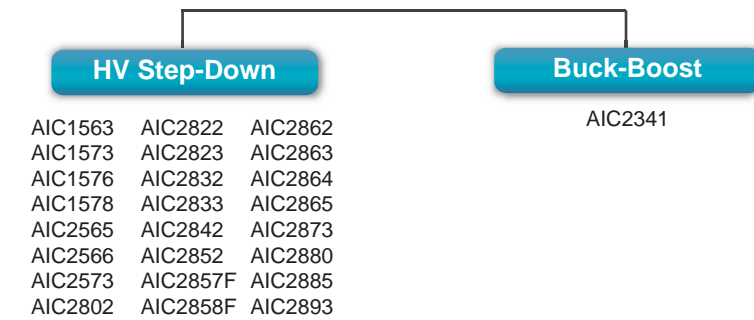

White-LED Drivers p6

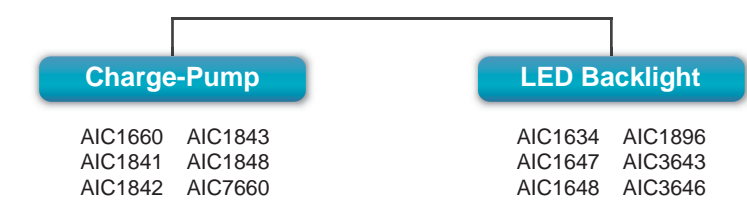

Note:

Information provided by AIC is believed to be accurate and reliable. However, we cannot assume responsibility for use of any circuitry other than circuitry entirely embodied in an AIC product; nor for any infringement of patents or other rights of third parties that may result from its use. We reserve the right to change the circuitry and specifications without notice.

Life Support Policy:

AIC does not authorize any AIC product for use in life support devices and / or systems. Life support devices or systems are devices or systems which, (i) are intended for surgical implant into the body or (ii) support or sustain life, and whose failure to perform, when properly used in accordance with instructions for use provided in the labeling, can be reasonably expected to result in a significant injury to the user.

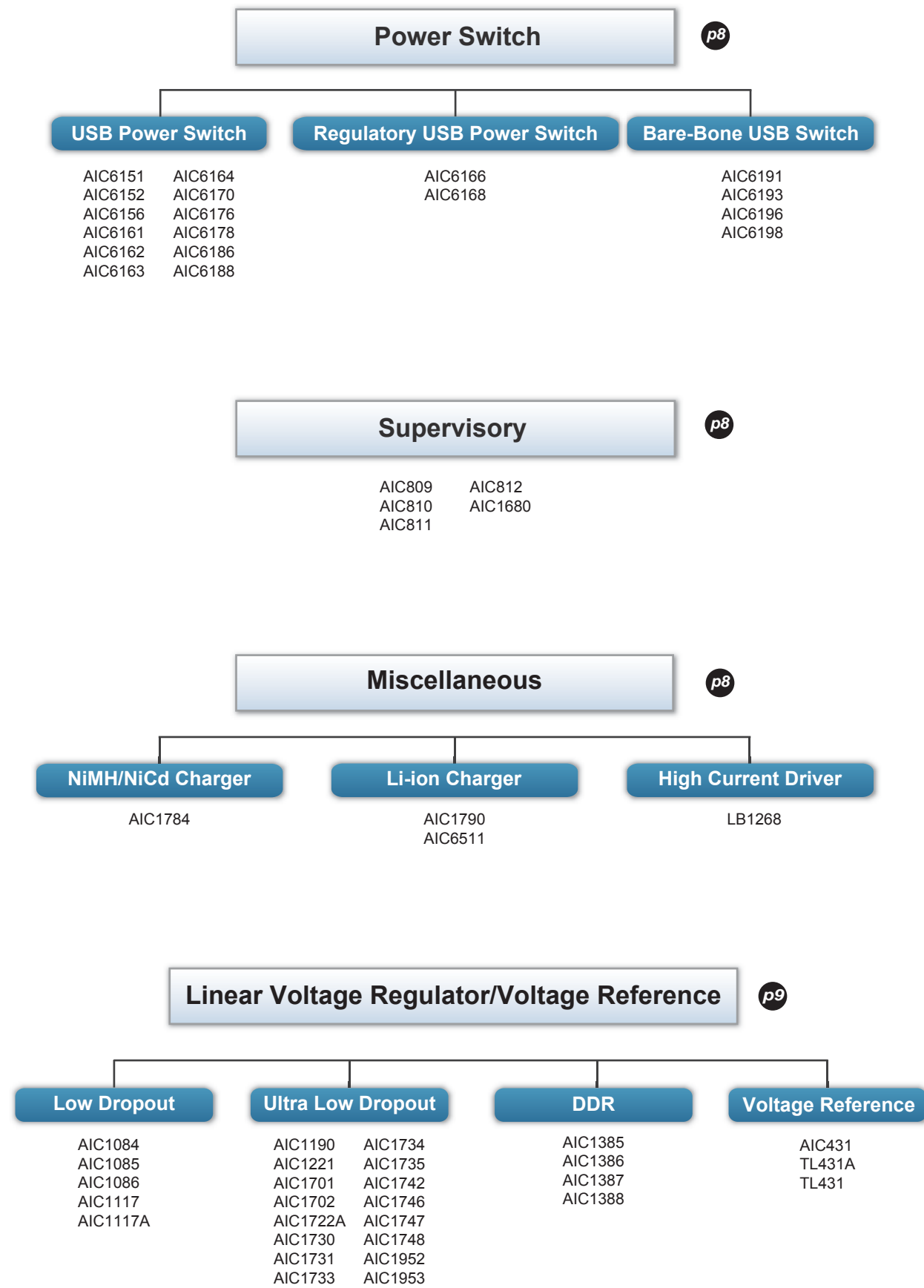

Buck Converters

Output Current		≤1.5A	≤2A	≤3A	≤5A
HV Buck	V _{IN} up to 36V			AIC2893 AOT	
	V _{IN} up to 23V		AIC2822 AIC2857F AIC2862	AIC2823 AIC2858F AIC2863	
	V _{IN} up to 16V		AIC2832 AIC2842 AIC2852 AIC2880	AIC2833 AIC2873 AOT	AIC2864(4A) COT AIC2865(5A) COT AIC2884 AIC2885
LV Buck	V _{IN} up to 6V	AIC2140 AOT (Ultra Low Iq 0.3µA) AIC2253 AOT AIC2256 AOT AIC2258 AOT AIC2259 AOT AIC2385 AIC2354 AIC2359(Dual)	AIC2262 AOT AIC2321/22 AIC2361/62	AIC2323 AIC2363 AIC2369	AIC2324(4A) AIC2364(4A) AIC2367(5A)

Boost Converters

Switch Current Limit		≤1A	≤2A	≤3A	≤5A
Boost	V _{OUT} up to 40V		AIC3646		
	V _{OUT} up to 30V	AIC1634 AIC1647 AIC1896 AIC3643			
	V _{OUT} up to 24V	AIC3632 AIC3634			
	V _{OUT} up to 11V		AIC1880		
	V _{OUT} up to 5.5V	AIC1642 AIC3402 (Low Iq 3µA) AIC3411/12 AIC3413	AIC3415	AIC3417	AIC3418 AIC3420(6.5A)
Buck-Boost	V _{OUT} up to 6V		AIC2341		

Power Switch

Current Limit	Single Channel	Dual Channel	
USB Power Switch	≤1A	AIC6151(I _o Adj.) AIC6161	AIC6186
	≤2A	AIC6152(I _o Adj.) AIC6162(1.4A) AIC6163 AIC6170(I _o Adj.)	AIC6176(1.25A) AIC6178 AIC6188(1.55A)
	≤3A	AIC6156 (Fast SCP 1.3µS, Curr. Accuracy ±7~15%) AIC6164(3.2A)	
Regulatory USB Power Switch	≤1A	AIC6166 AIC6168 (Fast SCP 4µS)	
Bare-Bone Power Switch	≤1A	AIC6191	AIC6196
	≤2A	AIC6193	AIC6198

Part No.	Supply Voltage (V)		Output Voltage (V)	Current Function (A)			Control Mode A:AOT, C:COT, F:PFM, S:PSM, W:PWM	Freq. (KHZ)	Description	Package
	min.	max.		Internal Switch	External Switch	Low IQ				
Step Up Series										
AIC1610	1.1	5.5	1.8 ~ 5.5	1.0		20μA	F	500	High Efficiency Synchronous Step-Up PFM DC/DC Converter	MSOP-8
AIC1611	1.1	5.5	1.8 ~ 5.5	0.65		20μA	F	500	High Efficiency Synchronous Step-Up PFM DC/DC Converter	MSOP-8
AIC1628	4	20	V _{IN} ~ 4.5x V _{IN}			0.3 (BJT)	100μA	90 - 250	High-Efficiency, Step-Up PFM-PSM DC/DC Controller	SOP-8
AIC1634	2.6	10	V _{IN} ~ 30V	0.5			100μA	1400	1.4MHz Current-Mode Step-Up PWM DC/DC Converter	SOT23-6
AIC1638	0.9	6	2.7/3.0/3.3/4.5/5.0			0.04~0.35	15μA	105	1-Cell, 3-Pin, Step-Up PFM DC/DC Converter	SOT89-3
AIC1639	0.9	6	3.3/5.0			0.5 (BJT)	18μA	105	1-Cell, 3-Pin, Step-Up PFM DC/DC Controller	SOT89-3
AIC1642	0.9	6	2.0/2.2/2.7/2.8/3.0/3.1/3.3/3.7/4.5/5.0			0.6	15μA	105	3-Pin One-Cell Step-Up PFM DC/DC Converter	SOT23-3, SOT23-5, SOT89-3, TO92-3
AIC1647	2.5	5.5	V _{IN} ~ 30V				70μA	1200	White LED Step-Up PWM Converter	SOT23-5
AIC1880	2.6	5.5	V _{IN} ~ 11V	1.6			180μA	640 - 1220	Low Noise, Step-Up PWM DC/DC Converter	MSOP-8
AIC1896	2.5	10	V _{IN} ~ 30V				100μA	1400	1.4MHz SOT23-6 Current-Mode Step-Up PWM DC/DC Converter	SOT23-6
AIC3402	0.75	5	2.0/2.2/2.7/2.8/3.0/3.3/5.0	0.5			3μA	800	Synchronous Step-Up DC/DC Converter	SC70-3, SC70-5, SOT23-3, SOT23-5
AIC3411	0.7	5	1.65 ~ 5.5V	0.4			7μA	-	SC70-6 Package Low IQ High Light Load Efficiency Synchronous Boost Converter	SC70-6
AIC3412	0.7	5	1.65 ~ 5.5V	0.48			12μA	-	Low No-Load Input Current Synchronous Constant Off Time/PSM Step-Up Converter	SOT23-6
AIC3413	0.9	5.5	2.7 ~ 5.25V	0.9			40μA	1200	400mA, 1.2MHz Synchronous Step-Up Converter	SOT23-6
AIC3415	0.9	5.5	2.7 ~ 5.25V	1.3			40μA	1200	700mA, 1.2MHz Synchronous Step-Up Converter	SOT23-6
AIC3417	0.9	5.5	2.5 ~ 5.5V	3.4	1		20μA	-	1.0A Synchronous Step-Up Converter	DFN-10 (3x3), SOP-8E
AIC3418	0.9	5.5	2.5 ~ 5.5V	4.5	1.5		20μA	-	1.5A Synchronous Step-Up Converter	DFN-10 (3x3), SOP-8E
AIC3420	0.9	5.5	2.5 ~ 5.5V	6.5	2.1		20μA	-	2.1A Synchronous Step-Up Converter	DFN-10 (3x3), SOP-8E
AIC3632	2.7	5.5	V _{IN} ~ 24V	0.1			30μA	-	2.1A Synchronous Step-Up Converter	SOT23-6
AIC3634	2.7	5.5	V _{IN} ~ 24V	0.48			60μA	-	PFM Mode Step-Up DC/DC Converter With True Shutdown	SOT23-6
AIC3643	2.5	5.5	V _{IN} ~ 22V	1.0			150μA	1200	Built-in OVP White LED Step-Up Converter	SOT23-6, TSOT23-6
AIC3646	7	28	V _{IN} ~ 40V	2				1000	8 String White LED Driver with Active Current Balancing for LCD Panel Backlight	QFN-20 (4x4)
LV Step Down Series										
AIC2140	2.2	5.5	1.8V ~ 3.3	0.6	0.3		0.36μA	2000	300mA Ultra Low Iq Step-Down DC/DC Converter with AOT Control	DFN-12 (2.4x2.4)
AIC2253	2.5	6	0.6V ~ V _{IN} -0.2	1.6	1.0		8μA	1500	1A, 1.5MHz AOT Synchronous Step-Down DC/DC Converter	TSOT23-8
AIC2256	2.5	6	0.6V ~ V _{IN} -0.2	1.6	1.0		17μA	3000	1A, 3MHz AOT Synchronous Step-Down DC/DC Converter	TSOT23-8
AIC2258	2.5	6	0.6V ~ V _{IN} -0.2	1.6	1.0		17μA	1500	1A, 1.5MHz AOT Synchronous Step-Down DC/DC Converter	TSOT23-8
AIC2259	2.5	6	0.6V ~ V _{IN} -0.2	1.6	1.0		17μA	1500	1A, 1.5MHz AOT Synchronous Step-Down DC/DC Converter	TSOT23-8
AIC2262	2.5	6	0.6V ~ V _{IN} -0.2	3.4	2.0		17μA	1500	2A, 1.5MHz AOT Synchronous Step-Down DC/DC Converter	TSOT23-8, DFN-8 (2x1.5)
AIC2304	2.5	5.5	0.6V ~ V _{IN} -0.3	1.6	1.0		65μA	1500	1A Synchronous PWM Step-Down DC/DC Converter	DFN-6 (2x2), SOT23-5
AIC2309	2.5	5.5	0.6V ~ V _{IN} -0.3	1.6	1.0/1.0		65μA	1500	1A Dual Synchronous PWM Step-Down DC/DC Converter	DFN-12 (3x3)
AIC2321	2.7	6	0.8V ~ V _{IN}	3.4	2.0			1200	2A 1.2MHz Synchronous PWM Step-Down Converter	DFN-10 (3x3)
AIC2322	2.5	6	0.8V ~ V _{IN}	3.4	2.0		550μA	550/1100	2A 550k/1.1MHz Synchronous PWM Step-Down Converter	SOP-8
AIC2323	2.5	6	0.8V ~ V _{IN}	5.0	3.2		550μA	550/1100	3.2A 550k/1.1MHz Synchronous PWM Step-Down Converter	SOP-8E
AIC2324	2.5	6	0.8V ~ V _{IN}	6.4	4.0		250μA	550/1200	4A 550k/1.2MHz Synchronous PWM Step-Down Converter	DFN-12 (3x3), SOP-8E
AIC2354	2.5	5.5	0.6V ~ V _{IN} -0.3	1.6	1.0		65μA	1500	1A Synchronous PWM-PSM Step-Down DC/DC Converter	DFN-6 (2x2), SOT23-5
AIC2359	2.5	5.5	0.6V ~ V _{IN} -0.3	1.6	1.0/1.0		65μA	1500	1A Dual Synchronous PWM-PSM Step-Down DC-DC Converter	DFN-12 (3x3)
AIC2361	2.7	6	0.8V ~ V _{IN}	3.4	2.0			1200	2A 1.2MHz Synchronous PWM-PSM Step-Down Converter	DFN-10 (3x3)
AIC2362	2.5	6	0.8V ~ V _{IN}	3.4	2.0		200μA	550/1100	2A 550k/1.1MHz Synchronous Step-Down Converter with High Light-Load Efficiency	SOP-8, SOP-8E
AIC2363	2.5	6	0.8V ~ V _{IN}	5.0	3.2		200μA	550/1100	3.2A 550k/1.1MHz Synchronous Step-Down Converter with High Light-Load Efficiency	DFN-10 (3x3), SOP-8E
AIC2364	2.5	6	0.8V ~ V _{IN}	6.4	4.0		250μA	550/1200	4.0A 550k/1.2MHz Synchronous Step-Down Converter with High Light-Load Efficiency	DFN-12 (3x3), SOP-8E
AIC2367	3	5.5	0.8V ~ V _{IN}	7.5	5.0		550μA	1000	5A 1MHz Synchronous PWM/PSM Step-Down Converter with Light Load Efficiency	SOP-8E
AIC2369	2.8	5.5	1V ~ V _{IN}	5.0	3.2			1000	3.2A 1MHz Synchronous PWM/PSM Step-Down Converter with High Light Load Efficiency	DFN-10 (3x3), SOP-8E
AIC2385	2.5	5.5	0.6V ~ V _{IN} -0.3	2.0	1.5		65μA	1500	1.5A Synchronous PWM/PSM Step-Down DC/DC Converter	SOT23-5
Inverting Series										
AIC1650	4	20	-1.22V ~ -40V			0.025 (BJT)	100μA	100 - 320	High-Efficiency, Inverting PFM DC/DC Controller	SOP-8
AIC1652	2.4	7	-1.22V ~ -40V			0.025 (BJT)	80μA	70 - 160	Micro-Power Inverting PFM DC/DC Controller	SOP-8
AIC1653	1.8	10	-1.23V ~ -28V	0.1			15μA	-	Micropower Inverting PFM DC/DC Converter in SOT23-5	SOT23-5

Glossary:

(1) V_{REF} could be the minimum V_{OUT}. In the application, V_{OUT} depends on the designed external resistors.

Please check with datasheets for more information.

(2) Internal Switch I_{OUT}: built-in switch output current. I_{SW} Limit: Internal switching current limit Maximum I_{OUT} can never exceed I_{SW} limit.

Max. I_{OUT}=(Efficiency) • (V_{IN}/V_{OUT}) • I_{SW}

(3) External Switch I_{OUT}: Possible external power switch I_{OUT}. The external device driving capacity may change the I_{OUT} value, possibly greater than the max.

I_{OUT}, shown in the table above. The real I_{OUT} depend on the external device's driving capability. (BJT : β ; MOS : G_m)

Example: If customers request -> V_{IN}=1.5V(Alkaline Battery) and minimum V_{IN}=1.1V; V_{OUT}=3.3V(I_{OUT}=250mA); Low battery detective is needed.

High efficiency (>90%) is needed.

Solution: Choose AIC1610 for the solution

Part No.	Supply Voltage (V)		Output Voltage (V)	Current Function (A)			Control Mode A:AOT, F:PFM, S:PSM, W:PWM, C:COT	Freq. (KHZ)	Description	Package	
	min.	max.		Internal Switch	External Switch	Low IQ					
				I _{SW} Limit	I _{OUT}						
HV Step Down Series											
AIC1563	3	30	1.25V ~ V _{IN}	2	1.5		1.6mA	S	0.1~100	Versatile DC/DC Converter	DIP-8, SOP-8, SOP-8E
AIC1573	3	30	1.25V ~ V _{IN}	2	1.5		1.6mA	S	0.1~100	1.5A Step-down DC/DC Converter	SOP-8E
AIC1576	4	18	1.22V ~ V _{IN}			5	90μA	S-F	90~280	High-Efficiency, Step-Down DC/DC Controller	SOP-8
AIC1578	4	18	1.22V ~ V _{IN}			5	90μA	S-F	90~280	High-Efficiency, Step-Down DC/DC Controller	DIP-8, SOP-8
AIC2565	4.75	23	1.22V ~ 16V	5	3		600μA	W	385	3A, 23V Step Down DC/DC Converter	SOP-8E
AIC2566	4.75	23	0.92V ~ 16V	5	3		600μA	W	385	3A, 23V Step Down DC/DC Converter	SOP-8E
AIC2573	4.5	25	0.8V ~ V _{IN}			10	2mA	W	300	Synchronous Buck DC-DC Controller	MSOP-10
AIC2802	4.5	23	0.925V ~ 12V	5.5	3		1.9mA	W	340	3A, 23V Synchronous Step-Down Converter with LDO Controller	SOP-8E
AIC2822	4.75	23	0.925V ~ 12V	3.4	2		700μA	W	550	2A, 23V Synchronous Step-Down Converter	SOP-8E
AIC2823	4.75	23	0.925V ~ 12V	5.8	3		700μA	W	340/550	3A, 23V Synchronous Step-Down Converter	SOP-8E
AIC2832	4.5	16	0.8V ~ 10V	4	2		0.5mA	S-W	490	2A 16V 490KHz PWM/PSM Synchronous Step-Down Converter	SOT23-6
AIC2833	4.5	16	0.8V ~ 10V	4.2	3		0.5mA	S-W	490	3A 16V 490KHz PWM/PSM Synchronous Step-Down Converter	SOT23-6
AIC2842	4.5	16	0.8V ~ 10V	3.5	2		0.5mA	S-W	1200	2A 16V 1.2MHz PWM/PSM Synchronous Step-Down Converter	SOT23-6
AIC2852	4.5	16	0.6V ~ 10V	3.5	2		0.5mA	S-W	500/700	2A 16V 500kHz/700kHz PWM/PSM Synchronous Step-Down Converter	SOT23-6
AIC2857F	4.75	23	0.925V ~ 12V	3.4	2		1.3mA	W	340	2A, 23V Synchronous Step-Down Converter	SOP-8, SOP-8E
AIC2858F	4.75	23	0.925V ~ 12V	5.8	3		1.3mA	W	340	3A, 23V Synchronous Step-Down Converter	SOP-8E
AIC2862	4.75	23	0.925V ~ 12V	3.4	2		700μA	S-W	340/550	2A, 23V Synchronous Step-Down Converter with High Light-Load Efficiency	SOP-8E
AIC2863	4.75	23	0.925V ~ 12V	5.8	3		700μA	S-W	340	3A, 23V Synchronous Step-Down Converter with High Light-Load Efficiency	SOP-8E
AIC2864	4.5	16	0.8V ~ 6V	6.5	4		0.7mA	C	700	4A 16V 700kHz Synchronous Step-Down Converter	SOP-8E
AIC2865	4.5	16	0.8V ~ 6V	7.5	5		0.7mA	C	700	5A 16V 700kHz Synchronous Step-Down Converter	SOP-8E
AIC2873	4.5	17	0.9V ~ 5.5V	4.2	3		19uA	A	2500	3A 17V Synchronous Step-Down Converter with AOT Control	QFN-16
AIC2880	4.5	16	0.6V ~ 10V	3.5	2		0.5mA	S-W	500/700	2A 16V 500kHz/700kHz PWM/PSM Synchronous Step-Down Converter with PG	SOP-8E
AIC2885	4.5	16	0.8V ~ 5V	7.5	5		0.5mA	A	700	5A 16V 699kHz Synchronous Step-Down Converter with PG	SOP-8E
AIC2893	4.5	36	0.8V ~ 6V	5.5	3		0.7mA	A	650	3A 36V 650kHz Synchronous Step-Down Converter	SOP-8E
Buck-Boost Series											
AIC2341	2.5	5.5	1.8V ~ 5.5V	1.8	1		60μA	S-W	2500	2.5MHz Synchronous Buck-Boost DC/DC Converter	DFN-10 (3x3)
Charge Pump Series											
AIC1660	1.5	6	(-V _{IN}), 0.5V _{IN} , 2.0V _{IN}		0.2		36μA		10/50	Switched-Capacitor Voltage Converter	DIP8, SOP-8
AIC1841	2.7	5.5	5.0V (up to 4 WLEDs)		0.02		1mA	W	1000	High Efficiency 1.5x PWM Charge Pump For 4 White LEDs Backlighting	QFN-12 (3x3), QFN-12 (4x4)
AIC1842	2.7	5.5	5.0V (up to 6 WLEDs)		0.02		1mA	W	1000	High Efficiency 1.5x PWM Charge Pump For 6 White LEDs Backlighting	QFN-16 (3x3), QFN-16 (4x4)
AIC1843	2.7	5.5	5.0V (up to 4 WLEDs)		0.02		1mA	W	1000	High Efficiency 1.5x PWM Charge Pump For 4 White LEDs Backlighting	DFN-12 (3x3)
AIC1848	2.7	4.5	5		0.3		3mA	W	1800	Regulated 5V PWM Charge Pump In SOT-23 For White LEDs Backlighting	SOT23-6
AIC7660	1.5	6	(-V _{IN}), 0.5V _{IN} , 2.0V _{IN}		0.2		30μA		10/50	Switched-Capacitor Voltage Converter	DIP-8, SOP-8
LED Backlight											
AIC1634	2.6	10	V _{IN} ~ 30V		0.5		100μA	W	1400	1.4MHz Current-Mode Step-Up PWM DC/DC Converter	SOT23-6
AIC1647	2.5	5.5	V _{IN} ~ 30V				70μA	W	1200	White LED Step-Up PWM Converter	SOT23-5
AIC1648	2.5	5.5	V _{IN} ~ 30V				70μA	W	1200	Built-in OVP White LED Step-Up Converter	SOT23-6, TSOT23-6
AIC1896	2.5	10	V _{IN} ~ 30V				100μA	W	1400	1.4MHz SOT23-6 Current-Mode Step-Up PWM DC/DC Converter	SOT23-6
AIC3643	2.5	5.5	V _{IN} ~ 22V		1		150μA	W	1200	Built-in OVP White LED Step-Up Converter	SOT23-6, TSOT23-6
AIC3646	7	28	V _{IN} ~ 40V		2		150μA	W	1000	8 String White LED Driver with Active Current Balancing for LCD Panel Backlight	QFN-20 (4x4)

Part No.	Supply Voltage max. (V)	Rds-on (mΩ)	No. of Channel	Short-Circuit Protection Response Time	Current Limit (A)	Current (A)	Accuracy (%)	Package
USB Power Switch								
AIC6151	5.5	60	1	1.3 μS	0.5 ~ 1.2	1	±15	SOT23-6
AIC6152	5.5	60	1	1.3 μS	0.5 ~ 2.4	2	±15	SOT23-6
AIC6156	5.5	60	1	1.3 μS	0.5 ~ 3.6	3	±15	SOP-8E, SOT23-6
AIC6161	6.5	85	1		0.55 ~ 1	0.5	±25	SOT23-5
AIC6162	6.5	85	1		0.85 ~ 1.4	0.75	±25	SOT23-5
AIC6163	6.5	85	1		1.1 ~ 2	1	±25	SOT23-5
AIC6164	6.5	85	1		1.6 ~ 3.2	1.5	±25	SOT23-5
AIC6170	5.5	85	1		0.4 ~ 2	2	±7 ~ 12	SOT23-6
AIC6176	6.5	100	2		0.6 ~ 1.25	0.5	±30	SOP-8
AIC6178	6.5	100	2		1 ~ 2	1	±30	SOP-8
AIC6186	6.5	85	2		0.52 ~ 0.8	0.5	±20	SOP-8
AIC6188	6.5	85	2		1.05 ~ 1.55	1	±20	SOP-8

Regulatory USB Power Switch								
AIC6166	7	150	1		0.62/1.25	0.5/1	±20	SOP-8E
AIC6168	7	150	1	4 μS	0.72/1.45	0.5/1	±18	SOP-8E

Bare-Bone USB Switch								
AIC6191	5.5	170	1		0.55 ~ 1	0.5		SOT23-3
AIC6193	5.5	170	1		1.05 ~ 1.8	1		SOT23-3
AIC6196	5.5	170	2		0.55 ~ 1	0.5		SOT23-5
AIC6198	5.5	170	2		1.05 ~ 1.8	1		SOT23-5

Part No.	Supply Voltage (V)	Supply Current max. (μA)	Detecting Voltage Accuracy	Detector Threshold Hysteresis	Reset Active Timeout Period (mS)	Package
Supervisory						
AIC809	0.9 ~ 6	3	±1.5%		230 (typ.)	SOT23-3
AIC810	0.9 ~ 6	3	±1.5%		230 (typ.)	SOT23-3
AIC811	0.9 ~ 6	3	±1.5%		230 (typ.)	SOT143-4, SOT23-5
AIC812	0.9 ~ 6	3	±1.5%		230 (typ.)	SOT143-4, SOT23-5
AIC1680	1.5 ~ 10	4.8	±2.5%	0.05 V _{DET}	0.2	SOT23-3, SOT23-5, TO92-3

Part No.	Charging Set	-ΔV Cutoff	0ΔV Cutoff Time (of Safety Timer)	ΔT-Δt Cutoff	Safety Timer Cutoff	Max. Voltage Cutoff	Max. Temp. Cutoff	Package
NiMH- NiCd Battery Charger								
AIC1784	Single	Yes	1 mode (6%)	Yes	Yes	Yes	Yes	DIP-8, SOP-8

Part No.	Input Volt. Range (V)	Charge Current Range (mA)	Charge Termination	Battery Recharge	Safety Timer Cutoff	Battery Temp. Protection	Package
Li-ion Charger							
AIC1790	4.5 ~ 5.5	200 ~ 1000	1/10 Full Charge Current	Yes	Yes	Yes	DFN-10 (3x3), MSOP-10E
AIC6511	4.5 ~ 6	2000	1/10 Full Charge Current	Yes	Yes	Yes	TSSOP-16E

Part No.	Supply Voltage max. (V)	Input Voltage max. (V)	Output Voltage max. (V)	Channel No.	Output Current (mA)	Package
High Current Driver						
LB1268	8.0	12	10	3	1000	DIP-8, SOP-8

Part No.	Input Voltage max. (V)	Output Voltage (V)	Output Current	Output Voltage Accuracy	Package
Low Dropout Linear Regulator					
AIC1084	7	1.8/2.5/3.3/adj	5A	±1%	TO220-3, TO252-3, TO263-3
AIC1085	7	1.8/2.5/3.3/adj.	3A	±1%	TO220-3, TO252-3, TO263-3
AIC1086	7	1.8/2.5/2.85/3.3/5.0/adj.	1.5A	±1%	SOT223-3, TO220-3, TO252-3, TO263-3
AIC1117	7	1.8/2.5/3.3/adj.	800mA	±1%	SOT223-3, TO220-3, TO252-3, TO263-3
AIC1117A	7	1.8/2.5/3.3/adj.	1A	±1%	TO252-3, TO263-3, TO252-3, SOT263-3

Ultra Low Dropout Linear Regulator					
AIC1190	6	0.8 ~ 5.0V, in step of 0.1V	1A	±2%	SOP-8E, SOT223-3, TO252-3, TO252-4, TO252-5, TO263-3, TO263-5
AIC1221	6	0.8 ~ 5.5V, in step of 0.1V	2A	±2%	SOP-8E, SOT223-3, TO252-3, TO252-5
AIC1701	6	0.8 ~ 5.0V, in step of 0.1V	150mA	±2%	SOT23-3, SOT23-5
AIC1702	6.8	0.8 ~ 5.0V, in step of 0.1V	350mA	±2%	SOT23-3, SOT23-5, SOT89-3
AIC1722A	8	1.5/1.8/2.0/2.5/2.7/3.0/3.3/3.5/3.7/3.8/5.0	300mA	±2%	SOT23-3, SOT89-3, TO92-3
AIC1730	12	1.8 ~ 3.3V, in step of 0.1V	150mA	±2%	SOT23-5
AIC1731	12	1.5/1.8/2.5/2.8/3.0/3.3	300mA	±2%	SOT23-5, SOT89-5
AIC1733	12	1.3/1.5/1.8/2.5/3.3	500mA	±2%	SOT23-5, SOT89-5
AIC1734	12	1.8/2.0/2.5/2.7/3.0/3.3/3.5/3.7/3.8/5.0	300mA	±2%	SOT23-3, SOT89-3, TO92-3
AIC1735	12	1.8/2.5/3.3/3.5/3.8/5.0	500mA	±2%	SOT223-3, SOT23-3, SOT89-3, TO252-3
AIC1742	9	1.5/2.0	150mA	±2%	SOT23-5
AIC1746	6.0	1.1 ~ 4.2V, in step of 0.1V	150mA	±2%	DFN-6 (2x2), SOT23-3, SOT23-5
AIC1747	7	1.1 ~ 4.2V, in step of 0.1V	300mA	±2%	DFN-6 (2x2), SC70-3, SC70-5, SOT23-3, SOT23-5, SOT89-3, SOT89-5
AIC1748	7	0.8 ~ 4.5V, in step of 0.1V	600mA	±2%	SOT23-3, SOT23-5, SOT89, SOT223-3, TO252
AIC1952	7	Dual: 0.8 ~ 3.8V, in step of 0.1V	300mA/300mA	±2%	DFN-6 (2x2), SOT23-6
AIC1953	7	Dual: 0.8 ~ 3.8V, in step of 0.1V	600mA/600mA	±2%	SOP-8E

Part No.	Input Voltage max. (V)	Output Voltage (V)	Output Current	Load Regulation	Package
DDR Regulator					
AIC1385	5.5	adj.	2A	±20mV	SOP-8E
AIC1386	5.5	adj.	2A	±20mV	SOP-8E
AIC1387	5.5	adj.	3A	±20mV	SOP-8, SOP-8E
AIC1388	5.5	adj.	3A	±20mV	SOP-8E

Part No.	Cathode Voltage max. (V)	Reference Voltage (V)	Sink Current	Reference Voltage Accuracy	Package
Voltage Reference					
AIC431	30	2.495	250μA ~ 200mA	±0.5%	SOP-8, SOT23-3, SOT89-3, TO92-3
TL431A	30	2.495	250μA ~ 200mA	±1.0%	SOP-8, SOT23-3, SOT89-3, TO92-3
TL431	30	2.495	250μA ~ 200mA	±1.6%	SOP-8, SOT23-3, SOT89-3, TO92-3

COMPANY PROFILE

Overview

Based in Hsinchu Science Park of northern Taiwan, AIC was founded in Jan 1992 and is an IC fabless company exclusively devoted to designing, testing and marketing power management integrated circuits.

By leveraging AIC's extensive product portfolio and quick responses to customized requests, we quickly emerged as a leading IC solution provider of power management in the Pacific Rim to help customers meet the demanding challenges of the dynamic market.

AIC has a long-standing reputation for offering solutions with products of best-in-class quality and reliability performance. In addition to the compliance to ISO9001 and ISO14001 standards, AIC has been certified by many global tier one customers in light of our robust quality management system and outstanding product quality, as illustrated in below achievements

Average Outgoing Quality

Visual Mechanical

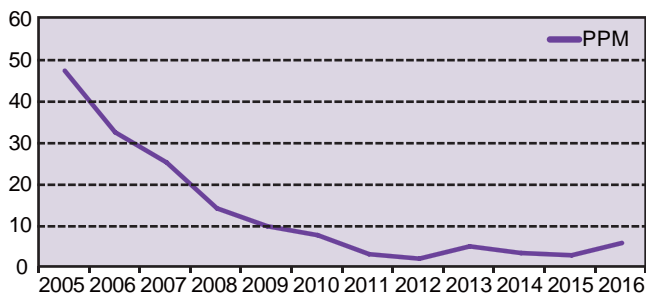

Final Electrical

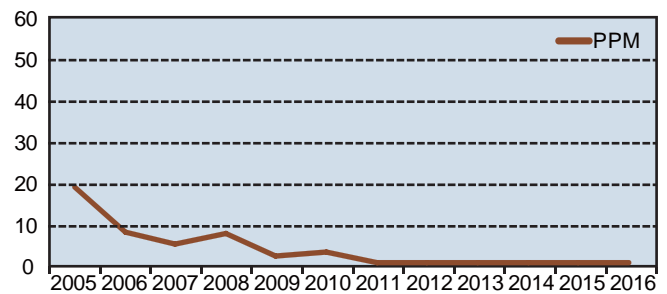

Customer Certification List

Customer	Customer Certification	Year
Nintendo	Green Procurement Certificate	2012
Ricoh	Certificate of Approval of Production Audit	2008
LGE	Green Program Certificate	2007
Samsung	Eco-Partner Certificate	2007
Canon	Green Activity Certificate	2005
SONY	SONY Green Partner Certificate	2003

Sales Channel

AIC HEADQUARTERS
Si-Soft Research Center, 1A1, 1 Lhsin 1st Rd.,
Science Park, Hsinchu 300, Taiwan.
TEL: +886-3-577-2500
TEL: +886-3-577-2510
E-MAIL: sales@analog.com.tw

AIC CHINA (Shenzhen)
Room 610, Building 212, Tairan Industrial
& Trade Park, Tairan 9th Rd.,
Futian District, Shenzhen, China
TEL: +86-755-2396-8525
FAX: +86-755-2396-8560
E-MAIL: sales@aicchina.com.cn

Ihr Vertriebspartner:

HY-LINE[®]
POWER COMPONENTS

Inselkammerstraße 10
D-82008 Unterhaching
Tel: +49 (0)89 614 503 10
Fax: +49 (0)89 614 503 20
E-Mail: power@hy-line.de
www.hy-line.de

Hochstraße 355
CH-8200 Schaffhausen
Tel: +41 (0)52 647 42 00
Fax: +41 (0)52 647 42 01
E-Mail: power@hy-line.ch
www.hy-line.ch

AIC TAIPEI
5F, 368 Xinhua 1st Rd., Nei-hu
Dist., Taipei 114, Taiwan
TEL: +886-2-2791-9100
FAX: +886-2-2791-9190
E-MAIL: sales@analog.com.tw

AIC INTERNATIONAL
TEL: +886-3-2791-9100 ext.652
E-MAIL: international@analog.com.tw

AIC JAPAN (Tokyo)
3F, Otomi Bldg.
5-8-11, Asakusabashi, Taito-ku
Tokyo, 111-0053, Japan
TEL: +81-3-6869-7440
E-MAIL: hiroshi_kondo@analog.com.tw